

Fānau au 'a e 'Otua,

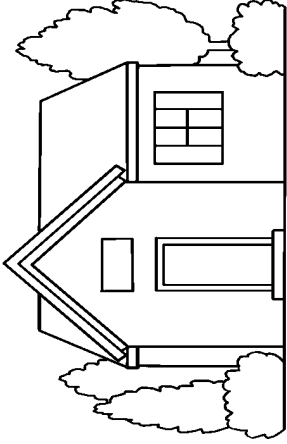

Kuó Ne fekau mai,



Ke u ha'u ki he māmani

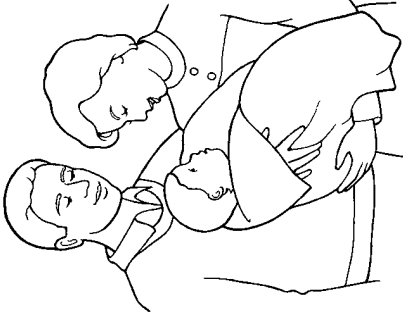

Mo e ongomātu'á.

### Fānau Au 'a e 'Otua (Ngāue 17:22-31).

Kosi'i 'o to'o e ongo fo'i tapafā lōlōa pea fakapipiki fakataha'i kinaua ke fa'u ha fo'i la'ipepa lōlōa pē taha. Pelu fefokifokira'aki 'i he ngaahi laine 'ull'ulif 'o hangē ha kī'i i pelupelú pe accordion ke fa'u ha kī'i tohi.

Fakapipiki heni

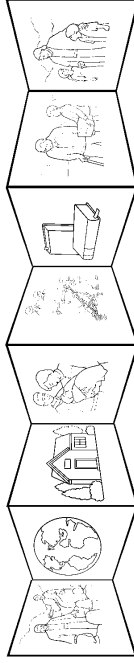

Fakapipiki heni

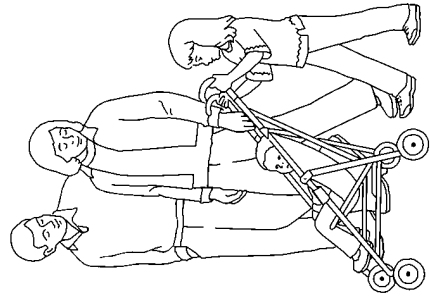
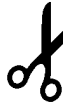

Taki au, 'eva mo au

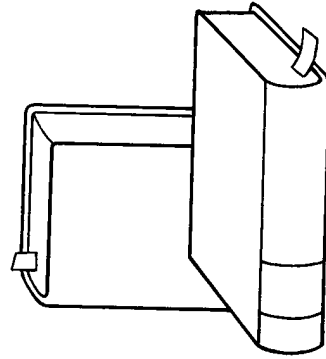

ke u 'ilo 'a e halá.

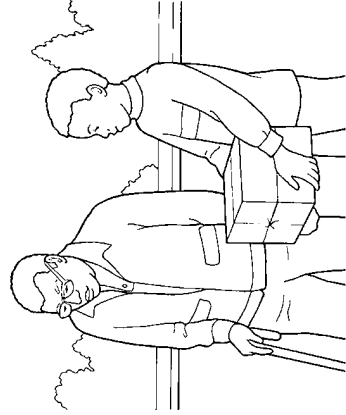

Ako'i au ke u failelei.

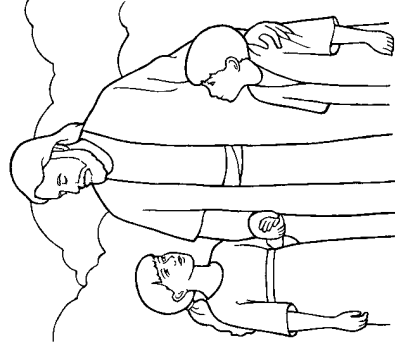

Ke nofo mo ia ha 'aho.