

Ang pananampalataya ay nanggagaling sa pakikinig ng salita ng Diyos (Mga Taga Roma 10:17).

Kulayan at gupitin ang mga larawan at ang lalagyan. Itupi ang lalagyan sa tulduk-tuldok na linya, at iteyp o i-stapler ang maiikling gilid. Ipasok sa lalagyan ang mga larawan ng mga paraan na naririnig natin ang salita ng Diyos.

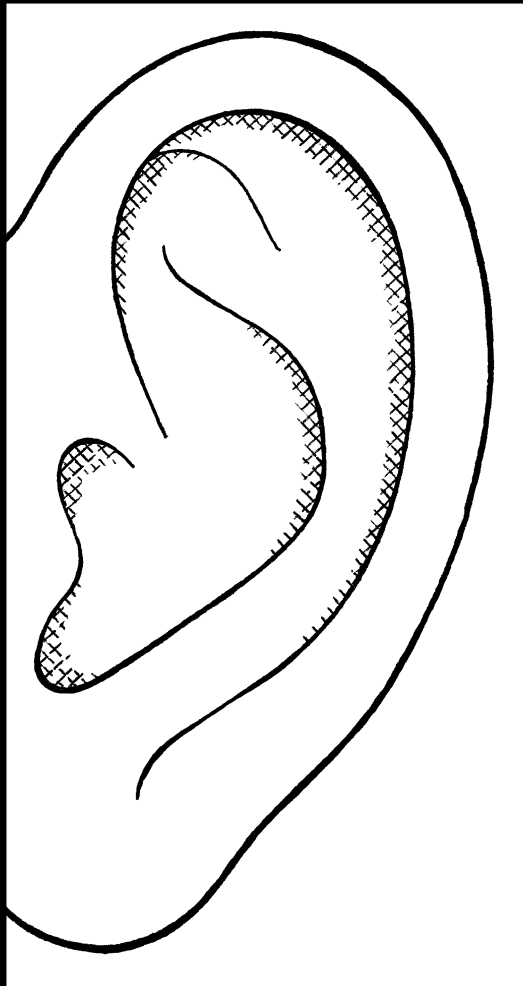
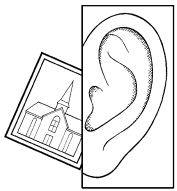
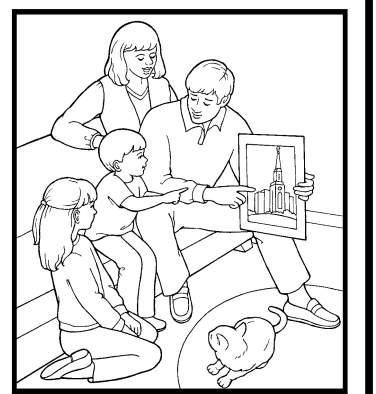
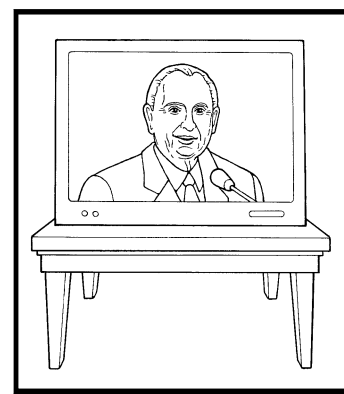
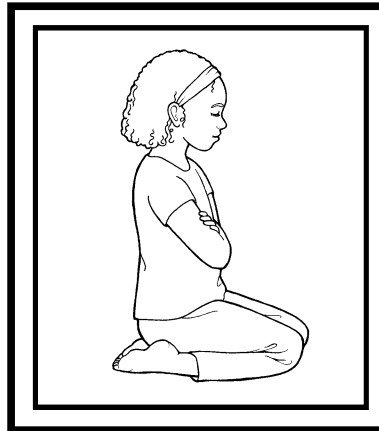
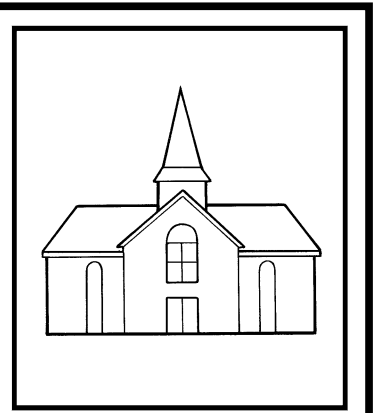
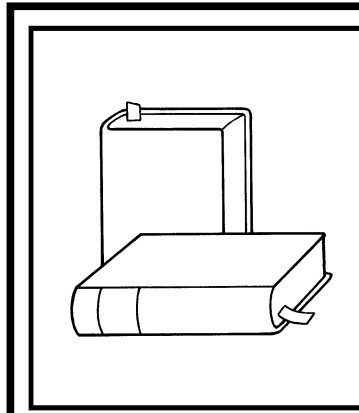

**Ang pananam-
palataya ay
nanggagaling
sa pakikinig ng
salita ng Diyos.**

**(Mga Taga Roma
10:17)**