

Ako ay anak ng Diyos,

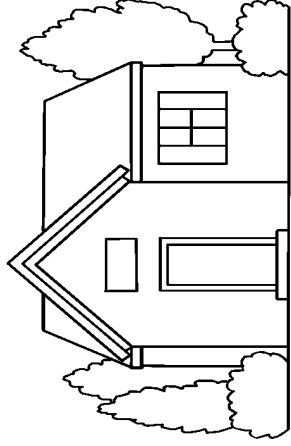

Dito'y isinilang,



Handog sa 'kin ay tahana't

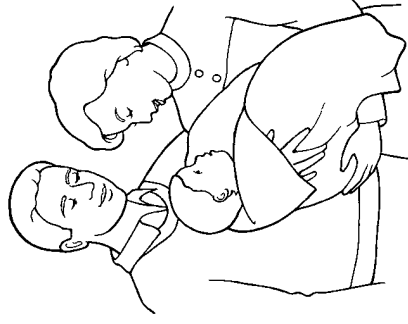

Mabuting magulang.

Ako ay anak ng Diyos (Mga Gawa 17:22-31).

Gupitin ang dalawang mahabang parihaba at iteyp ang mga ito para makagawa ng isang mahabang strip. Itupi ang mga itim na linya nang papunta sa harap at papunta sa likod na tulad ng isang accordion para makagawa ng isang maliit na buklet.

Iteyp dito

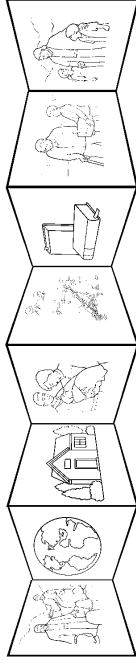

Iteyp dito

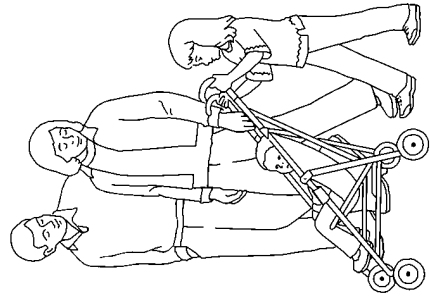
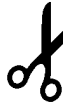

Akayin at patnubayan

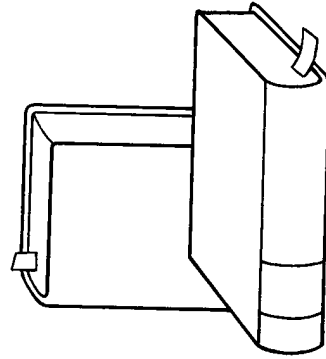

Sa tamang daan.

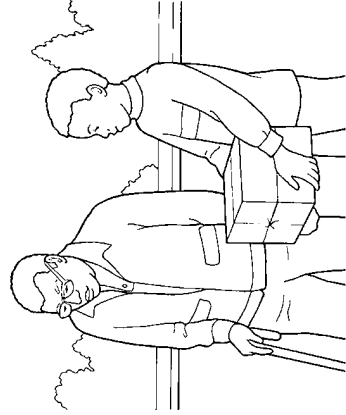

Turuan ng gagawin,

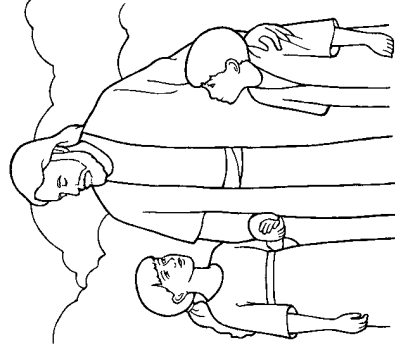

Nang S'ya'y makapiling.