

"Siak ti anak ti Dios,

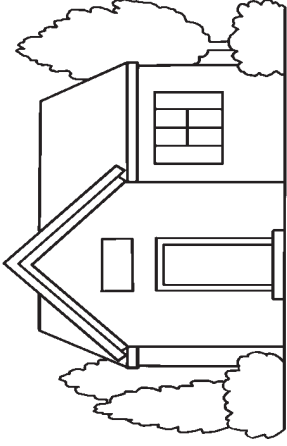

Imbaonnak ditoy,



Inikkannak pagtaengan

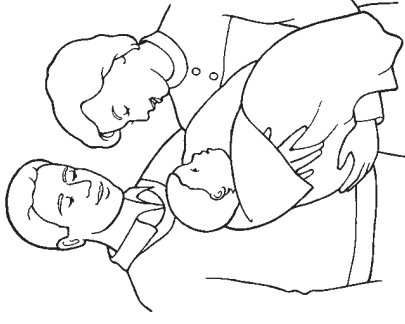

Nagannak a naanus.

Maysaak nga anak ti Dios (Dagiti Aramid 17:22-31).

Gettengen ti dua nga atiddog a rektanggulo ket i-tape dagitoy tapno agaramid iti atiddog nga akikid a piraso. Ikulpi ti likud ken sango kadagiti nangisit a linia kas accordion tapno agaramid iti maysa a bassit a buklet.

I-tape ditoy

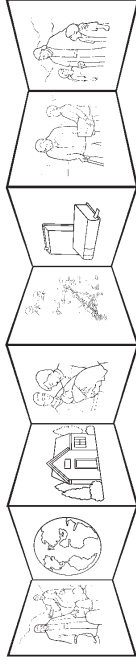

I-tape ditoy

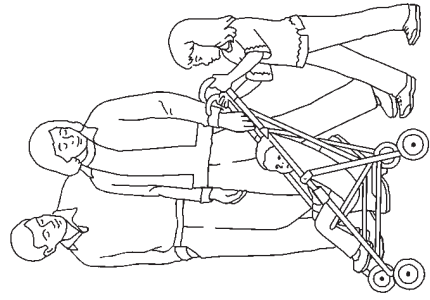

iturongnak, idalannak,

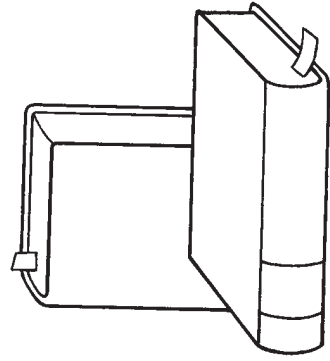

Tarabayennak.

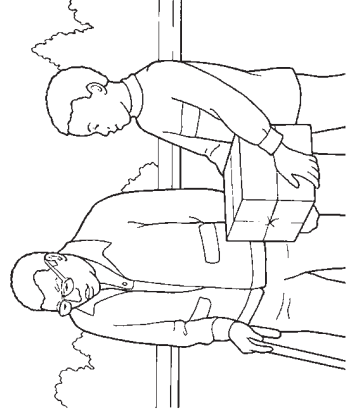

Isuronak ti aramidek

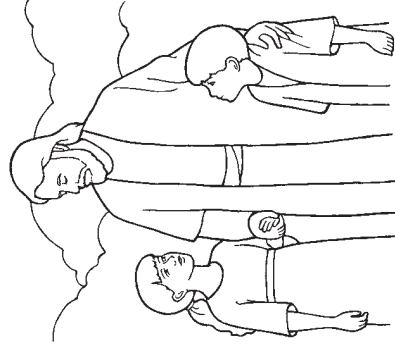

Ta agbiagak Kenkuana."