

Mimi mwana wa Mungu,

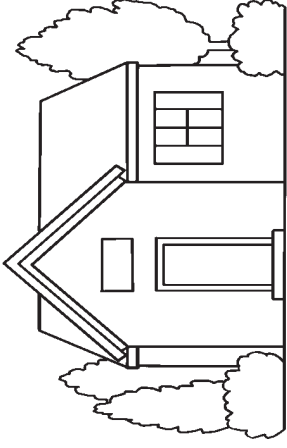

Kanileta hapa,



Kanipa makao mema

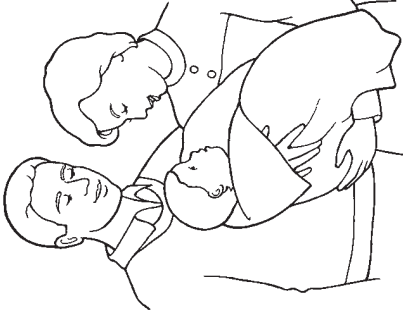

Na wazazi wema

Mimi ni mtoto wa Mungu (Matendo ya Mitume 17:22-31).

Kata mistatili hii miwili ndefu na uishikanishe kwa gundi pamoja kutengeneza mshipi mrefu. Kunja nyuma na mbele kwenye mistari Mieusi kama kodiani ili kutengeneza kijitabu kidogo.

Uganisha kwa gundi hapa

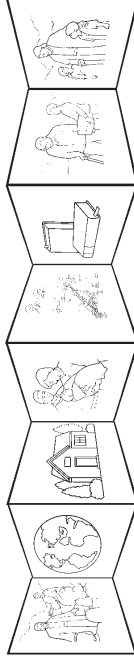

Uganisha kwa gundi hapa

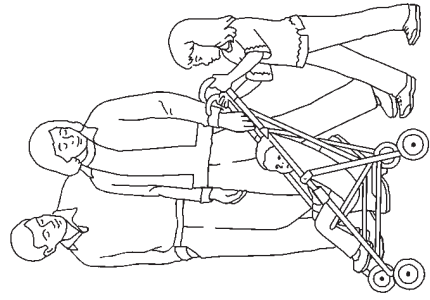

Niongoze, kaa nami,

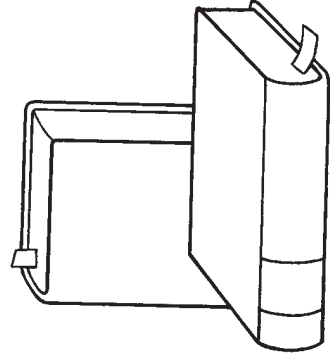

Unifundishe.

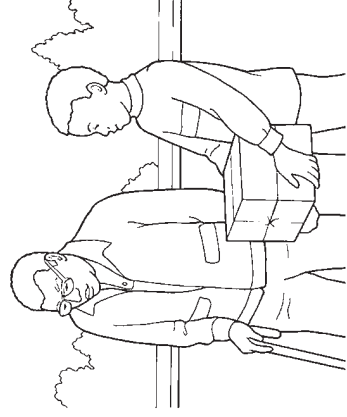

Unionyeshe njia

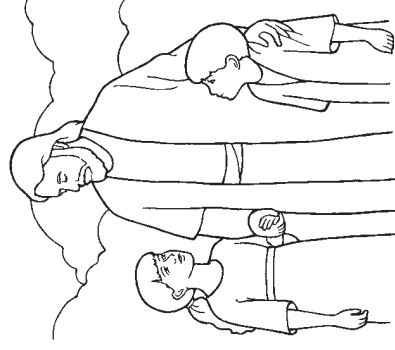

Ya kujia kwako.