

난 하나님의 자녀

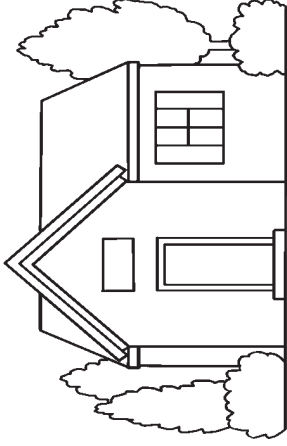

날 세상에 보내



부모와 함께 살도록

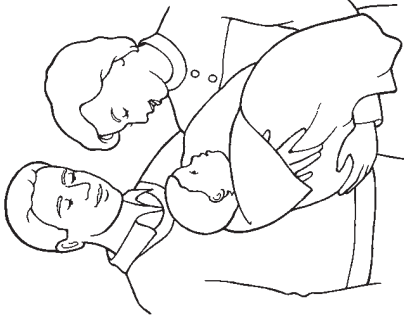

가정을 주셨네.

테이프 붙이는 곳

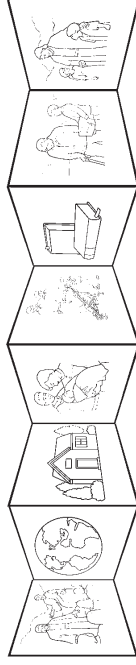

테이프 붙이는 곳

난 하나님의 자녀(사도행전 17:22~31)

두 개의 긴 직사각형을 잘라내어, 테이프로 붙여서 하나의 긴 띠를 만든다. 검은 선 부분을 따라 이코디언 모양으로 앞뒤로 접어 작은 책을 만들어 본다.

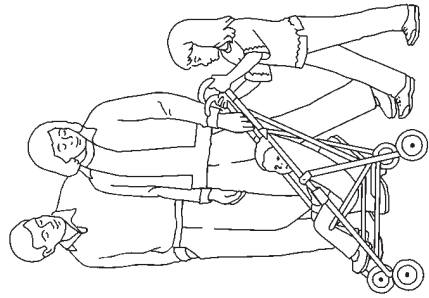

길을 찾아가게

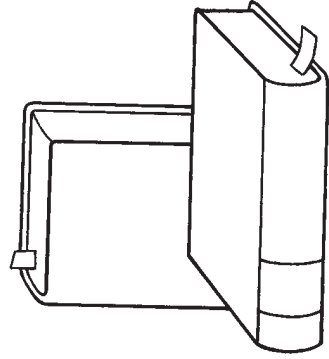

저를 도와주소서.

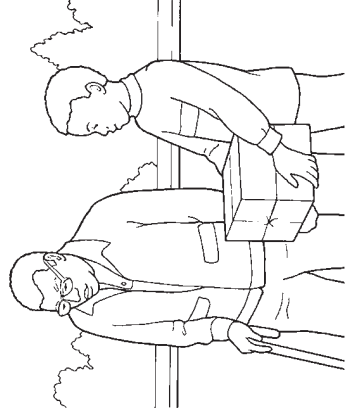

주와 함께 살도록

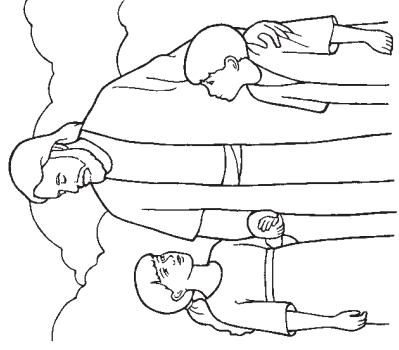

가르쳐 주소서.