

# THE Friend



You are  
**SUPER!**

See pages 24-25



# FRIENDS by Mail

## How I Read the *Friend*

We like to read the *Friend* while we wait for sacrament meeting to start and during the sacrament. This helps us be reverent while we think of Jesus and feel the Spirit. The stories help us think of how we can be like Jesus.

**Rachel, Nichole, Michelle, Paul, Sammy, and Peter W., ages 11, 10, 7, 5, 3, and 1, Kansas, USA**



## Dear Friends,

One of our favorite things is reading the letters children send us from all over the world. We often notice how kind children are to their family, friends, and neighbors—and even to people they don't know! Turn to page 24 to find out how you can be Super Kind. It's a great super power to have!

Kindly,

The *Friend*

P.S. Write and tell us how you show kindness!

Was there a story or activity this month that helped you? Tell us about it! Turn to page 39 to find out how.

## Pesos for Heavenly Father



The story “Pesos for Heavenly Father” (April 2016) taught me that if you keep the commandments and have faith in Heavenly Father, He will bless you.

**Ashlynn P., age 8, Dhaka Division, Bangladesh**

## Stained-Glass Picture

We made our own stained-glass picture (July 2015). After we painted the bright colors and excitedly pulled off the tape, we decided it looked like a city. We got out our cars and played with our new city!

**Evan, Zion, Taryn, Haven, and Graydon P., ages 10, 8, 6, 4, and 2, Arizona, USA**



## Warm and Fuzzy



I love to read the *Friend* to see what is new! Not only is it fun, but also it makes me feel warm and fuzzy inside.

**Aubrey W., age 10, North Carolina, USA**

◆ **Primary Connection** Find stories and activities to go with this month's sharing time theme and lessons.  
Find more at [lessonhelps.lds.org](http://lessonhelps.lds.org).

## CONFERENCE IS FOR ME!

- 2 A Conference Message from the Prophet
- 3 Conference News
- 4 Conference Notes
- 6 Show and Tell: Conference!

## STORIES AND FEATURES

- ◆ 8 An Origami Answer
- ◆ 10 Family Night Fun
- 12 Pie-Crust Cabins
- 16 The Great Family History Mystery
- 18 **Friends Who Stand Tall:** Never Give Up!
- 20 Abish and Abby
- 23 Question Corner
- 26 First Things First
- ◆ 28 **Answers from an Apostle:** Elder Ronald A. Rasband
- ◆ 30 **Book of Mormon Hero:** Mormon Remembered
- ◆ 31 I Can Read the Book of Mormon
- 33 Faithful Friends
- 38 Matt and Mandy
- 39 Stop and Flip

## MUSIC

- ◆ 22 Reverence Is Love

Front cover by Glenn Harmon

Back cover by Chris Jones

## FOR OLDER KIDS

- 34 Parker's Big Problem
- 36 It's Good to Be Me!

## THINGS TO MAKE AND DO

- 14 Funstuff: Hidden Picture
- ◆ 15 Funstuff: Scripture Hero Search
- 24 You Are Super!
- 32 **Happy Sabbath:** Ready, Set, Share-ades!
- 37 Funstuff: Puzzle Time!

## FRIEND JUNIOR

- IBC For Parents of Little Ones
- FJ1 Bright Idea
- FJ2 Big Sister Madelyn
- FJ3 Little or Big
- ◆ FJ4 **Book of Mormon Stories:** Mormon Writes on the Golden Plates
- FJ7 Coloring Page
- FJ8 Henry and the Corn Maze



## Hidden GTR Rings

**Level 1:** Long neck

**Level 2:** Who loves you?

**Level 3:** No hint!

### Volume 46 Number 11 November 2016

#### The First Presidency:

Thomas S. Monson, Henry B. Eyring,  
Dieter F. Uchtdorf

#### The Quorum of the Twelve Apostles:

Russell M. Nelson, Dallin H. Oaks, M. Russell Ballard,  
Robert D. Hales, Jeffrey R. Holland, David A. Bednar,  
Quentin L. Cook, D. Todd Christofferson, Neil L.  
Andersen, Ronald A. Rasband, Gary E. Stevenson,  
Dale G. Renlund

**Editor:** Joseph W. Sitati

**Assistant Editors:** Randall K. Bennett, Carol F.  
McConkie

**Advisers:** Brian K. Ashton, Jean B. Bingham,  
LeGrand R. Curtis Jr., Christoffel Golden, Douglas D.  
Holmes, Erich W. Kopschke, Larry R. Lawrence,  
Carole M. Stephens

**Managing Director:** Peter F. Evans

**Director of Church Magazines:** Allan R. Loyborg

**Business Manager:** Garff Cannon

**Managing Editor:** Jan Pinborough

**Assistant Managing Editor:** Marissa Widdison

**Copyeditor:** Lori Fuller

**Administrative Assistant:** Carrie Kasten

**Writing and Editing:** Bethany Bartholomew,  
David Dickson, Matthew Flitton, Charlotte Larcabal,  
Michael R. Morris, Eric Murdock, Richard M. Romney,  
Mindy Anne Selu

**Editorial Intern:** Maryssa Dennis

**Managing Art Director:** J. Scott Knudsen

**Art Director:** Mark W. Robison

**Design:** Thomas S. Child, Brad Teare

**Intellectual Property Coordinator:**  
Collette Nebeker Aune

**Production:** Marlene Roschek

**Prepress:** Joshua Dennis

**Printing Director:** Steven T. Lewis

**Distribution Director:** Troy K. Vellinga

© 2016 by Intellectual Reserve, Inc.

**All rights reserved.** The *Friend* (ISSN 0009-4102) is published monthly by The Church of Jesus Christ of Latter-day Saints, 50 E. North Temple St., Salt Lake City, Utah 84150-0024, United States of America. Periodicals Postage Paid at Salt Lake City, Utah.

**To subscribe:** By phone: Call 1-800-537-5971 to order using Visa, MasterCard, Discover Card, or American Express.

**Online:** Go to [store.lds.org](http://store.lds.org).

**By mail:** Send \$8 U.S. check or money order to Distribution Services, P.O. Box 26368, Salt Lake City, UT 84126-0368.

**To change address:** Send old and new address information to Distribution Services at the above address, or change the address by phone at the number listed above. Please allow 60 days for changes to take effect.

**Submit manuscripts or art to:**

*Friend* Editorial, 50 E. North Temple St. Rm. 2393, Salt Lake City, UT 84150-0024, United States of America. Unsolicited material is welcome, but no responsibility is assumed. For return, include self-addressed,

stamped envelope. Children's submissions will not be returned. Email: [friend@ldschurch.org](mailto:friend@ldschurch.org).

The *Friend* can be found on the Internet at [friend.lds.org](http://friend.lds.org).

Unless otherwise indicated, individuals may copy material from the *Friend* for their own personal, noncommercial use (including such use in connection with their calling in The Church of Jesus Christ of Latter-day Saints). This right can be revoked at any time and for any reason. Visual material may not be copied if restrictions are indicated in the credit line with the artwork. Copyright questions should be addressed to Intellectual Property Office, 50 E. North Temple St., FL 13, Salt Lake City, UT 84150, USA; email: [cor-intellectualproperty@ldschurch.org](mailto:cor-intellectualproperty@ldschurch.org).

**POSTMASTER:** Send all UAA to CFS (see DMM 507.1.5.2). **NONPOSTAL AND MILITARY FACILITIES:** Send address changes to Distribution Services, P.O. Box 26368, Salt Lake City, UT 84126-0368, USA.

**Canada Post Information:** Publication Agreement #40017431.



By President  
Thomas S.  
Monson

# Your Path to Happiness

## Steps on the Path

Heavenly Father's plan is the  
one perfect path to peace and  
happiness.

Believe  
in Jesus  
Christ.

Work  
and  
learn.

Search  
and  
pray.

Repent  
and  
improve.

Know God's  
laws and live  
them.

Receive  
His saving  
ordinances.

By doing  
these things, we  
will have true  
happiness.

Bransen M., age 7,  
Utah, USA



My brothers and sisters,  
I leave with you my love  
and blessing.

# KNOW SHARE LIVE

We are  
blessed to  
know the  
TRUTH.  
We must  
also share  
the TRUTH.  
Let us live  
the TRUTH.

*Adapted from "The Perfect Path to  
Happiness," from the October 2016  
general conference.*



# CONFERENCE

# NEWS



## THEY SANG OUR SONGS!

The Mormon Tabernacle Choir and others sang some of our favorite Primary songs!

“IF I LISTEN WITH MY HEART”

“I AM A CHILD OF GOD”

“MY HEAVENLY FATHER LOVES ME”

“BAPTISM”

“CALLED TO SERVE”

“I’LL FOLLOW HIM IN FAITH”



You can listen to these songs at [lds.org/general-conference/music](http://lds.org/general-conference/music).

## BOOK OF MORMON QUIZ

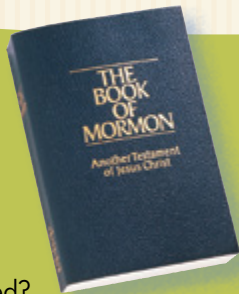

- When was it first published?
- How many copies have been printed?
- How many languages has it been translated into?
- What part of an arch is it like?
- How often does it talk about Jesus Christ?
- Elder Stevenson challenged us to read it for how many minutes every day?

Find the answers in Elder Gary E. Stevenson’s talk, “[Look to the Book, Look to the Lord](#).” Or check below.

Answers: 1830; 174 million; 110; the keystone; every 1.7 verses; at least 10 minutes

## CONFERENCE QUOTES



“The Sabbath is a day of gratitude and love.”

President Henry B. Eyring,  
First Counselor in the First Presidency

“Every time we forgive someone or ask for forgiveness, we can feel joy.”

President Russell M. Nelson of  
the Quorum of the Twelve Apostles



“Prayer is a gift from God. We need never feel lost or alone.”

Sister Carol F. McConkie,  
First Counselor in the Young Women  
General Presidency



“The reverent moments as priesthood holders pass the sacrament can become sacred to us.”

Elder Peter F. Meurs  
of the Seventy



# CONFERENCE NOTES

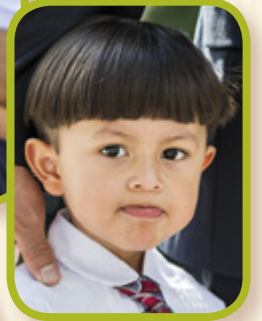

## Fourth Floor. Last Door



**P**resident Uchtdorf talked about two missionaries in Germany who were knocking on doors, looking for someone to teach. They got all the way up to the top floor and the last door of an apartment building before they met someone who would listen to their message. That family got baptized. One of the daughters was named Harriet, and when she grew up, she married President Uchtdorf! President Uchtdorf said he is very grateful that those missionaries didn't give up. When we seek the Lord, we shouldn't give up either.

## Joyful Repentance



**E**lder Renlund and his family lived in Sweden when he was 12. One Sunday another deacon brought a firecracker and matches to the Church building. Before others arrived, Elder Renlund lit the firecracker! He tried to put it out, but it exploded and filled the chapel with fumes. Nothing was damaged, but the smell distracted everyone in sacrament meeting. Elder Renlund felt so bad that he decided not to take the sacrament. After church he confessed to his branch president what he had done. Elder Renlund felt joy and happiness when he repented and knew he was forgiven.

What this teaches me:

What this teaches me:





## Golden Blessings



**S**ister Bingham told the story of a girl who saw a home with shining golden windows. Her own home seemed shabby in comparison. One day, the girl rode her bike across the valley to visit the house. When she got closer, she saw it was abandoned and falling apart. When she turned around, she was surprised to see a house with golden windows across the valley. It was her own house! The sun on the windows made the difference. When we count our blessings instead of comparing ourselves with others, we'll see the goodness of God in our lives.

## Believe in Yourself

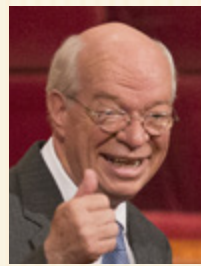

**E**lder Cornish told about a time he was very tired and discouraged while learning to be a doctor. He started crying and wondered if he could ever be a good doctor. Just then, one of the senior doctors asked how he was doing. Elder Cornish told him how he was feeling. The doctor said that he was proud of him and believed he would be an excellent doctor one day. The doctor believed in him even when Elder Cornish didn't believe in himself. Heavenly Father and Jesus Christ always believe in us and don't want us to give up!

What this teaches me:

What this teaches me:

# Show and tell CONFERENCE!



I liked the talk by President Eyring because it reminded me that we need to show love on the Sabbath.

We should be grateful that we can go to church because many people cannot come to church and renew their covenants. When we take the sacrament we remember that Jesus suffered for us.

**Yosselin L., age 11,  
Washington, D.C., USA**



I made this conference model! God chose the prophet to lead us. I love general conference and know that if we follow the prophet, we can hear the Lord.

**Ashton A., age 6, North Dakota, USA**



**Brynlee B., age 10, Washington, USA**



**Omar N., age 5, Baja California, Mexico,** traveled to the Conference Center to watch conference! His favorite part was seeing the prophet in real life.

**Taranaki F., age 9,  
Colorado, USA**



**Emmett, Sarah, and Claudia K.,  
ages 3, 11, and 6, Illinois, USA,** made sugar cookies and painted them while listening to the talks.





**M**y favorite talk was Sister McConkie's because she spoke about a very important and beautiful

topic, the Atonement of Jesus Christ. Jesus prayed to the Father and then bled from every pore to free us from our sins. Through His Atonement we can all be blessed and saved.

**Maria M., age 11, Rio Grande do Norte, Brazil**

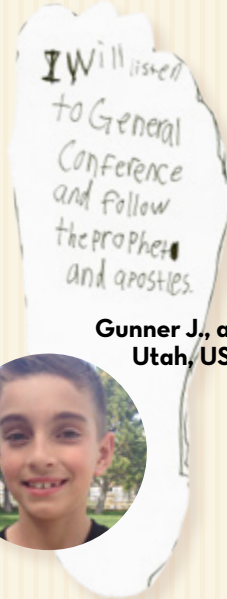

**Gunner J., age 9, Utah, USA**

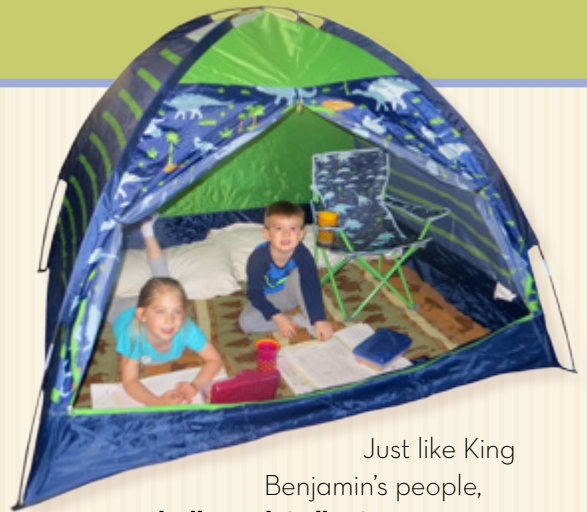
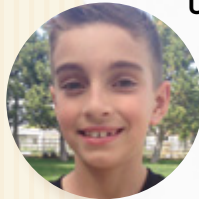

Just like King Benjamin's people, **Isabella and Collin S., ages 5 and 2, Colorado, USA**, faced their tent door toward the prophet to hear his words during conference.



**Kelsey, Mason, Eliza, and Jaren P., ages 7, 12, 9, and 14, Idaho, USA**, make cereal necklaces while they watch conference. This picture was taken while they were visiting their grandparents, who were serving a mission on Temple Square.



**E** liked the story about Mary Elizabeth Rollins, who wanted to read the Book of Mormon. Elder

Stevenson said this story reminds him that you are never too young to gain a testimony of the Book of Mormon, which means I can too!

**Esme F., age 11, Massachusetts, USA**

**Daniel R., age 9, Nevada, USA**



**I** liked Elder Hales's talk. If we help others, our Heavenly Father will be happy with us. I want

to continue helping my mom.

**Julian M., age 5, Santiago, Chile**



While watching conference, **Emily S., age 9, Missouri, USA**, built the St. Louis temple using beads!

# An ORIGAMI Answer

*“Be gentle and loving in deed and in thought, for these are the things Jesus taught” (Children’s Songbook, 78).*

**By Rachele Austin**  
(Based on a true story)

**G**ive it back!”  
“No, it’s mine!”

The kids sitting alone behind Jadyn had been pretty quiet during the sacrament, but now they kept distracting him.

“Mom, will you make them stop?” Jadyn whispered.

Mom turned and smiled at the kids. Then she looked around the chapel. “I think their parents are our speakers today,” she whispered back. Mom and Jadyn were visiting, so they knew hardly anyone in the ward.

Jadyn looked at the mom and dad sitting on the stand. They looked a little embarrassed. The kids were still fighting behind him.

*How could Jadyn help the other kids be reverent?*





Jadyn couldn't concentrate. How would he even hear the talks? Then he remembered it was sometimes easier to listen when his hands stayed busy. Sometimes he drew pictures of what the speakers were talking about. Two years ago Dad had taught him how to fold colorful square papers into Japanese origami. Now he could make lots of things, like animals and fancy boxes, without even looking at instructions.

Jadyn took a bright red piece of paper from his scripture bag and carefully folded it in half. But before he could continue, he heard more fighting behind him. He looked at Mom. She glanced back at the kids. Jadyn's forehead wrinkled as he thought about what to do. He couldn't think of anything. Then Mom leaned over and whispered something in Jadyn's ear. His eyes widened with surprise.

Jadyn looked back at the arguing kids. He didn't even know them! He felt butterflies fill his stomach. Would Mom's idea actually work?

He grabbed some extra paper. Then he took a deep breath and went to work. His fingers moved quickly to fold the bright colors.

Soon he had turned the flat pieces of paper into a colorful flapping bird and a jumping bunny. He turned around and shyly handed the bunny to the boy and the bird to the girl. Their eyes got big as they stared at their new treasures.

"Cool!" the boy whispered.

"Thanks!" said the girl.

The fighting ended as quickly as it had started. Jadyn's mom turned and smiled at him. The kids played happily and quietly with their origami for the rest of the meeting.

"Your talent made all the difference!" Mom said as they left the chapel. "You used your hands to serve someone. That's one reason God gives us all talents."

Jadyn looked over and saw the kids showing the origami animals to their parents. He was glad he'd helped.

He grinned. "I wonder what else I can do with my talents!" ♦

The author lives in Arizona, USA.

**Turn the page for an activity to go with this story!**

The most important part of sacrament meeting is the sacrament. It's a time to put away toys, books, and other things and quietly think about Jesus. Here's a scripture bookmark to help you remember why the sacrament is so important.

I renew my baptismal covenants each week when I **TAKE** the sacrament.

**T** TAKE HIS NAME UPON ME

**A** ALWAYS REMEMBER HIM

**K** KEEP HIS COMMANDMENTS

**E** ENDURE TO THE END



# Family Night

# FUN

## CHOOSE TO BE Reverent!

By Todd Huisken

Read "An Origami Answer" on page 4. Make this origami CTR shield to remember to choose to be reverent during sacrament meeting!

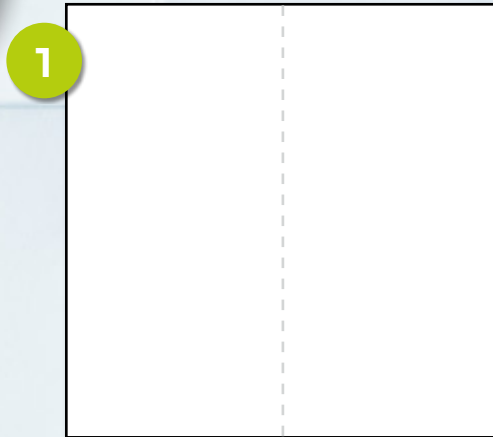

Fold a square piece of paper in half and lightly crease at the top and bottom. Open the paper flat again.

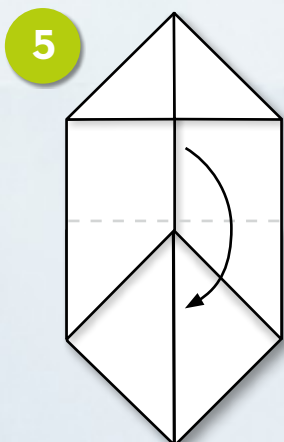
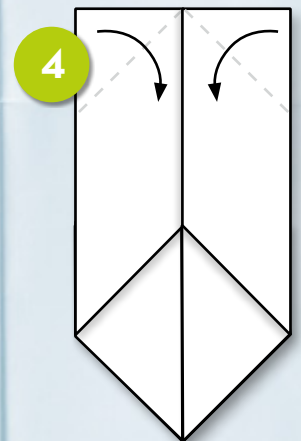
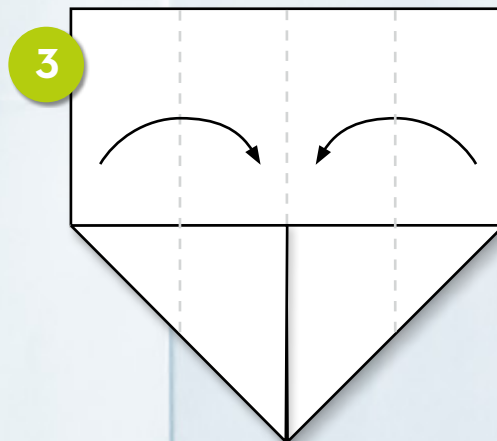
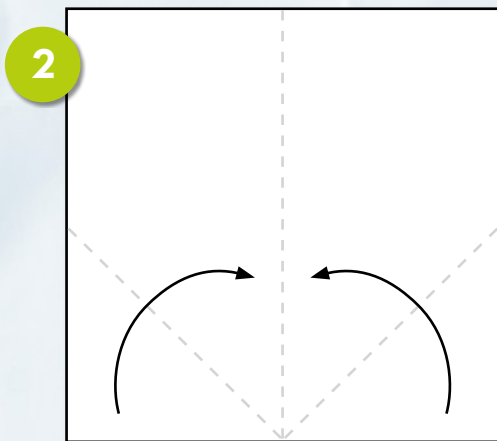

6 Fold the top point up about halfway.

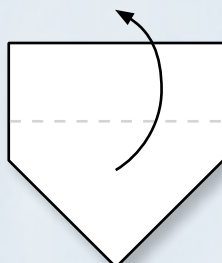

7 Tape the back to keep the shield flat. Then flip it over and decorate it.

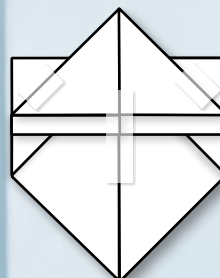





## LISTEN AND LEARN

When we listen and learn in sacrament meeting, we can become a little better each week! Here are some ideas:

- Take a notebook or journal to sacrament meeting.
- Listen carefully to what the speakers say.
- When something stands out, write down how you feel about it.
- Decide one thing to do during the week because of what you learned.

## TASTY TREATS

Try these for FHE this month!

- Mix 2 cups pecans, 1/3 cup maple syrup, 1 1/2 teaspoons cinnamon, and 1/2 teaspoon salt in a pan. Cook over medium heat until thickened. Spread on waxed paper to cool.
- Cut 4 large pears in half. Drizzle with 1/3 cup honey mixed with 2 tablespoons lemon juice. Broil for 6-8 minutes.
- Make mini sandwiches with dinner rolls, ham or turkey, and cheese.



## MORE FHE IDEAS

Look for these pictures in the magazine to find the stories and articles they go with! (Find the page numbers below.)



**IDEA 1:** Have everyone in your family take the quiz “It’s Good to Be Me!” Draw pictures of your answers like in the examples. Which pictures are the same in your family? Which are different?



**IDEA 2:** Make and decorate tithing jars! Read “First Things First” and talk together about how your family pays tithing. Maybe fill out a tithing slip together.



**IDEA 3:** Who are your family’s heroes? Why are they heroes? Read “You Are Super!” What superpowers can your family practice? (You could wear capes for this lesson!)

Idea 1: 36; Idea 2: 26; Idea 3: 24

# Pie-Crust Cabins

By Sara V. Olds

(Based on a true story)

*“For health and strength and daily food we praise thy name, O Lord” (Children’s Songbook, 21).*

Robbin watched as Dad measured flour, salt, and shortening into a bowl. After adding a little water, he started stirring the dough together.

“Can I help?” Robbin asked. “I want to make sure we make enough logs to make a *huge* house this year!”

“Sure, you can help,” Dad said. “But it doesn’t matter who builds the biggest house. We make log cabins to help us remember the blessings we have.”

Robbin’s eyebrows pinched together as she watched. “But you always tell us about the amazing house you and Mom built the first year you were married.”

Dad looked over at Mom and smiled. “There’s never been one like it since.” As he started rolling out the dough, he said, “As fun as our little crust cabins are, do you remember why we make them?”

Robbin nodded. “But tell me again.”

“A very long time ago,” Mom began, “long before even Grandma and Grandpa were born, there was a





young family. They lived on a farm. It wasn't an easy life. They had to work very hard. One year their daddy had to go away and find work so they'd have money to buy food. He left his wife and three daughters all by themselves."

"My great-grandma was one of the daughters, wasn't she?" asked Robbin.

Mom nodded. "That's right."

Robbin inched around the table so she could see Dad better. He cut the dough into thin strips and put them on

a cookie sheet. Then he slid them into the oven.

Mom went on with the story. "Well, Thanksgiving came and there was hardly anything to eat. Your great-great-grandmother felt sorry for her sweet little girls. But she had an idea. She took—"

"Flour," said Dad.

"And salt," said Robbin.

"And shortening," said Mom with a nod. "She made pie crust. Then she cut it into long strips. And then she took some cream from their cows and whipped it up. On Thanksgiving morning she and the girls used the pie crust and cream to make small log cabins."

Dad came over and leaned on the counter. "And we make our log cabins every year to remind us of the many blessings Heavenly Father has given us."

"And because it's fun!" said Robbin.

Mom and Dad laughed. "Yes, it is."

Dad checked the pie crust. The white strips he'd put in the oven had turned a beautiful golden color. "Done!" He slid the piecrust "logs" onto a rack to cool.

Robbin sniffed the freshly baked pie-crust logs. They smelled warm and delicious.

Later that day Robbin's cousins came over. Mom brought out a large plate piled high with logs ready to use. She put the plate next to a bowl of whipped cream. All the children hurried to the table.

"Wait!" said Mom. "Before you begin, who can remember the story of the log cabins?"

Robbin felt happy inside as one of her cousins started telling the story. They had a house and plenty of food. She was glad they had a special way to celebrate all the blessings Heavenly Father had given them. ◆

The author lives in Oregon, USA.



This tradition was Robbin's favorite part of Thanksgiving.

Know what's fun?  
Starting a new family tradition!

Like starting Thanksgiving in October with our friends in Canada!



My little brother drew a picture of us holding hands. He wrote, "I love you, Cate!" I taped it to my door. Soon he made another picture for my door. On Thanksgiving, I was wondering what I was most thankful for when I saw my door with the pictures on it. *I'm thankful for my siblings, I thought, especially Henry.*

**Cate L., age 9, Utah, USA**



# Hidden Picture

This pioneer family is glad to have a newly built log cabin. Can you find the hidden objects?  
**Bonus challenge:** Draw your own log cabin! What would you build it out of? Maybe pie crust?

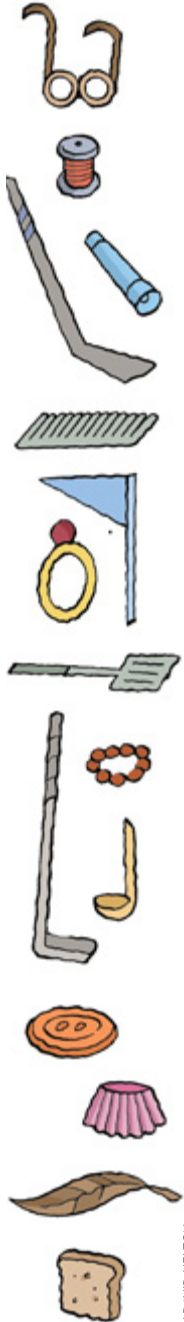

ILLUSTRATION BY DAVID HELTON



# Scripture Hero Search

Look up the scripture to find out which scripture hero goes in each blank. Check your answers on page 39.



## A Hero's Way

By Amanda Hill

I want to be like (1) \_\_\_\_\_, (1 Nephi 3:7)  
 With power to obey,  
 Or maybe like (2) \_\_\_\_\_, (Mosiah 11:20)  
 With truth that I must say.

Perhaps I'll be like (3) \_\_\_\_\_ (Alma 19:16)  
 And spread the joyous news,  
 Or serve the Lord like (4) \_\_\_\_\_, (Alma 17:25-39)  
 Who not a sheep did lose,

Courageous like (5) \_\_\_\_\_, (Alma 46:11-12)  
 With banner at his side,  
 Or the other (6) \_\_\_\_\_, (Mormon 8:1, 4)  
 Who had the plates to hide.

I open up the scriptures  
 And read from day to day.  
 The Book of Mormon shows me  
 How to walk a hero's way.

## Scripture SCRAMBLE

What made each of the people above a true hero? Use the clues to find out!

Number 3 ran from \_\_\_\_\_ to \_\_\_\_\_ to spread the news (see Alma 19:17).

What Number 4 brought to the king (see Alma 17:39): \_\_\_\_\_

What Number 5 called his banner (see Alma 46:13): \_\_\_\_\_

Number 1's favorite scripture prophet (see 2 Nephi 25:5): \_\_\_\_\_

Number 2 died by \_\_\_\_\_ (see Mosiah 17:13-15).

Write down just the first letter of your answers: \_\_\_\_\_

Now unscramble the letters! \_\_\_\_\_

**By Marinda Bush and Eric Murdock**

(Based on a true story)

*“Family history—I am doing it, My family history.  
And the love I feel when I’m doing it is very sweet to me”*  
(*Children’s Songbook, 94*).

**M**y family had an amazing mystery adventure in a cemetery. We felt like explorers—or detectives! We followed a map, looked for clues, and made it through lots of obstacles.

The mystery started when Grandma found a list of family members who were buried in a family cemetery. She wondered why her own grandpa wasn’t on the list.

Grandma knew he was buried there, but she had never visited the cemetery before because she lived far away.

“I wish we could help Grandma,” I said during dinner. I felt sad that Grandma couldn’t find out about her grandpa.

“I do too,” Dad said. “Maybe we can take a trip to the cemetery and find her grandpa’s headstone.”

I was excited to solve the mystery. My little brothers, Joseph, Hyrum, and Daniel were excited too!

First we had to drive a long way and do some detective work before we even found the cemetery. We stopped to ask a man if he knew where it was. Guess what! It was hidden down a road on his farm!

The cemetery was in the middle of a muddy field. It was surrounded by a cinder-block wall and covered with overgrown plants. We had to cut through vines just to open the gate.

It was like a jungle inside! Big trees filled the cemetery, and thorny vines

wrapped around the headstones. We had to clear them off to read the names.

“Who is Marena Ann Thomas Humphrey?” I asked, pulling plants off a headstone.

Dad ran over. “She’s your great-great-grandmother!” he said. “Hopefully your great-great grandpa’s headstone is nearby.”

We looked and looked for his headstone but couldn’t find it anywhere. Mom and Dad cut and cleared vines. My brothers and I cleaned off dirt, bugs, and spider webs. It was gross! Some headstones had tipped over because tree roots grew under them. They were heavy, but we worked together to lift them up again.

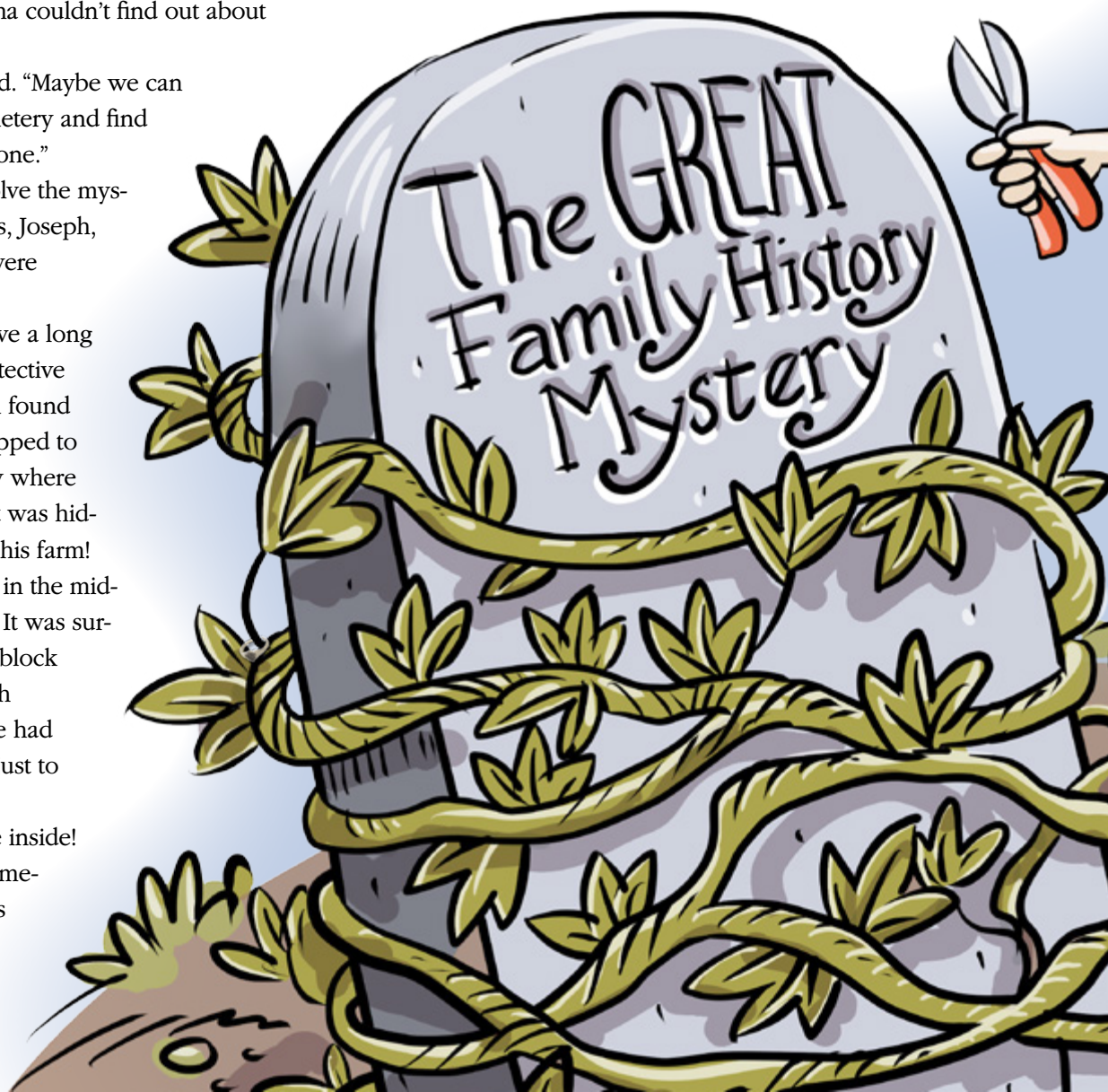



This was important  
to Grandma—  
we had to find it!



We worked hard all day. When the sun was going down, Dad said it was time to go.

“I don’t think we’re going to find it today,” he said. He sounded pretty disappointed.

I didn’t want to leave. I wanted to find the headstone for Grandma.

“Let’s say a prayer,” I said.

“That’s a great idea. Heavenly Father can help us find it,” said Mom.

We said a prayer and looked one last time. Dad found a long wire and used it to poke the ground. Suddenly the wire hit something solid. Maybe a headstone?

“I think Dad found something!” I said.

We knelt down and cleared away vines and weeds. Under a thin layer of dirt, we found a headstone. The name on it was *Rodolph Jackson Humphrey*.

“Dad, do you know who this is?” I asked.

When I looked at Dad, he had tears in his eyes.

“This is exactly what we were searching for! It’s your great-great grandpa’s headstone,” he said.

“Yay!” we all shouted.

I gave my brothers high fives. “I knew we’d find it! We just needed a little help,” I said.

Mom smiled. “That’s what prayer is for.”

It was tricky and fun searching through the cemetery. We had to overcome walls, mud, thorns, and vines. But it was all worth it to get to know more about my great-great grandpa.

I know that the Holy Ghost helped us and that Heavenly Father answered our prayer.

And the best feeling of all was hearing Grandma cheer when we told her all about it. ♦

The authors lives in Ankara, Turkey, and Utah, USA.



“What matters most is what lasts longest, and our families are for eternity.”

Elder M. Russell Ballard of the Quorum of the Twelve Apostles

“What Matters Most Is What Lasts Longest,” *Ensign*, Nov. 2005, 44.



# Never Give Up!

*From an interview by Amie Jane Leavitt*

I live on a farm, and a few years ago I was in a scary accident. But with Heavenly Father's help, here's how I stayed strong!

**Hi, I'm Dax!**

## Scary Accident

One day my family was herding cows. Suddenly my horse stopped. I fell forward and landed hard on the ground. I don't remember anything after that. My dad carefully picked me up and took me on his horse to where a truck could meet us.

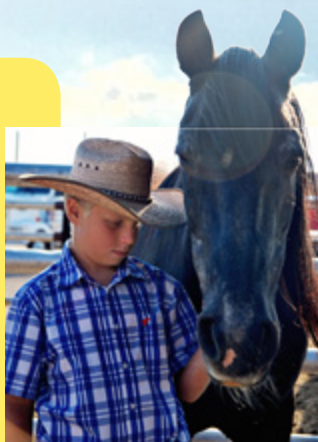

## Strength and Faith

I rode in a helicopter to a children's hospital. Before we left, I got a priesthood blessing from a doctor who was a member of the Church. He said that I would have strength to get well and faith to overcome my challenges.





## The Long Road

I stayed in the hospital for more than a month. My brain was injured, and I had to relearn how to do just about everything: walk, talk, and even swallow. But I didn't give up. I'm a hard worker, and I wouldn't quit no matter what! I had another priesthood blessing in the hospital. It said the same things about strength and faith. I knew those words came from Heavenly Father. I would get better!



### STAND TALL!

- Keep trying and never, ever quit.
- Show gratitude for your blessings.
- Thank the people who help you.

### Trying Again

When I first got home, I couldn't do chores on the farm. I couldn't ride a bike, throw a baseball, or even use my right arm. But I kept working and practicing every day, and now I can do all those things and more! I feed the dogs, water the horses, and move sprinkler pipes to water our crops. It might take me a little longer to do things now, but I still get it done!

### THANKS FOR YOUR FOOTPRINTS!

Look for a fun video about them next month. Thanks for standing tall!





# ABISH and

By Lana Krumwiede  
(Based on a true story)



**A**bish was a woman in the Americas long ago. She learned about Jesus Christ from her father. Abish lived with Lamanites, who didn't know about Jesus.

One day Ammon came to serve in King Lamoni's house. The king was impressed with Ammon and listened to him teach about Jesus. He felt the Spirit so strongly that he fainted.

After three days, Lamoni woke up. When he spoke about Jesus, the people were amazed. The king, queen, and Ammon were overpowered with joy and fainted again. Some felt the Spirit so strongly that they fainted too! Abish knew this was God's work.

Abish knew that *this* was the time to share her testimony. She invited other people to see what had happened. She helped the queen to her feet. The king and the others also woke up. Abish listened as King Lamoni taught about Jesus Christ. She felt the joy of sharing the gospel.



# ABBY

Whether you're a Lamanite or a Latter-day Saint, you can share your testimony!

**A** bby is a girl in the latter days. She learned about Jesus Christ from her parents. Abby's neighbors didn't know about Jesus Christ's Church.

One day Abby's brother got called as a missionary. He was going far away to teach people about Jesus.

Abby told her neighbors about her brother's mission call. When they heard her brother was going so far away, they were amazed. They asked what missionaries teach.

Abby's family knew that *this* was the time to share the gospel. Abby and her mother invited their neighbors to meet the missionaries, who could answer their questions.

Some of Abby's neighbors decided to meet the missionaries. Abby listened as the missionaries taught about Jesus Christ. She felt the joy of sharing the gospel. ◆

The author lives in Idaho, USA.









# Matt and Mandy's friend Audrey is getting baptized! How can they help her?



I think Matt and Mandy could help Audrey by giving her rides to church and other church activities, inviting her to their family home evenings, and giving her a copy of the Book of Mormon to study with their testimonies written inside.

**Anabelle T., age 9, Oklahoma, USA**



Matt and Mandy can help her by loving people and by helping her never do bad things. They could go to church with her.

**Avlyn H., age 4, Arizona, USA**



Help Audrey not be nervous by saying a prayer.

**Rocco D., age 7, California, USA**



One way to support a friend who gets baptized is to give friendship. Help them when they don't know something. You can also pray for them. Showing kindness and love to them will also help them feel supported.

**Gianna B., age 6, Florida, USA**



**Edwin:** Matt and Mandy can help Audrey by being her friend. They can play with her and invite her to church activities.



**Eliza:** Audrey might not have anyone to take her to church. Matt and Mandy can help Audrey by giving her support and being at her baptism. They can invite her to church activities such as activity days and invite her whole family to more family home evenings.

**Edwin and Eliza R., ages 5 and 9, Utah, USA**



I would ask Audrey if she wants to do a scripture challenge with me, so that she can feel the Holy Ghost.

**James B., age 8, Colorado, USA**



Pray for her to be comforted by the Holy Ghost and to feel welcome.

**Ella S., age 8, Virginia, USA**

Responses are intended for help and perspective, not as pronouncements of Church doctrine.

## NEXT QUESTION

**“My friends sometimes use their phones to look at bad pictures. What should I do?”**

Send us your answer and photo by November 30. Email us at [friend@ldschurch.org](mailto:friend@ldschurch.org) with “Question Corner” in the subject line. Use the permission statement on page 39.

**Read more answers on page 38!**



Jesus Christ set a super example for us to follow! As you grow up, you can work to become more like Him.

Cut out these reminders to keep or share with others. Fill in the last reminder with a goal of your own!



I can be **SUPER** brave!

“The Lord needs us to be brave, steadfast, and immovable warriors who will defend His plan.”

—Sister Bonnie L. Oscarson



I am **SUPER** loved!

“I know my Father lives and loves me too. The Spirit whispers this to me and tells me it is true.”

—Children’s Songbook, 5

ILLUSTRATIONS BY SIMINI BLOCKER

**YOU ARE SUPER!**





I can be  
**SUPER grateful!**

"Ask in prayer that God, by the power of the Holy Ghost, will help us see our blessings clearly even in the midst of our trials."

—President Henry B. Eyring



I can be  
**SUPER kind!**

"As we arise each morning, let us determine to respond with love and kindness to whatever might come our way."

—President Thomas S. Monson



I can be  
**SUPER patient!**

"Courageously trust the Lord's promises and His timing."

—President Dieter F. Uchtdorf

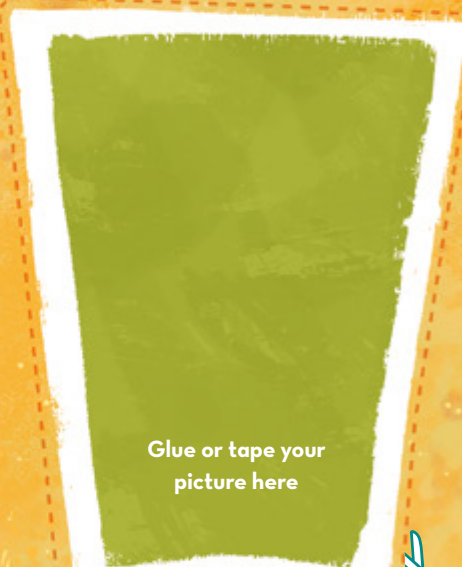

Glue or tape your  
picture here



I can be **SUPER** \_\_\_\_\_!

"I can do all things through Christ which strengtheneth me."

—Philippians 4:13





# FIRST THINGS FIRST

TUES.  
5 PM  
Meeting

Why do you put  
the tithing check on the  
refrigerator door?



**By Jane McBride Choate**

(Based on a true story)

*“I’m glad to pay a tithing”* (*Children’s Songbook*, 150).

**K**ai noticed that every other Friday, Dad put a check on the refrigerator door.

“What’s that?” Kai asked.

“It’s our tithing check,” Dad said. “I put it there to remind us that tithing comes first.” He put a magnet over the corner of the check. “I get paid every second Friday. The first check I write is for tithing.”

“Even before the house payment?” Kai knew his parents made a payment for the house every month. One time Dad had told him that if they didn’t pay it, they could get in trouble with the bank.

“Even before that,” Dad said. “Mom and I have always put tithing first. That’s one way of showing how important Heavenly Father is to us.”

Kai thought about it. “What if you don’t have enough money to pay tithing?”

“I’ve found that if you pay tithing first, the money works out. Or you find a way to do without.”

Kai remembered the time the car broke down. They didn’t have the money to fix it right away. But Dad said he didn’t mind walking to work for a few weeks.

“Wouldn’t Heavenly Father understand if you had to pay your tithing late?” Kai asked.

“Heavenly Father understands everything about our lives,” Dad said. “But when your mom and I were sealed in the temple, we made promises to the Lord and to ourselves. We decided that we would always pay our tithing first, before anything else.”

Kai thought of the allowance he got every week. Sometimes he forgot to pay tithing on it for a week or two. He thought about the money he earned mowing lawns around the neighborhood. It wasn’t a lot, since he was only 11. But he decided right then to pay his tithing first—just like his parents did.

From then on, every time Kai earned any money, he set aside his tithing before spending even one penny.

Many years later, Kai had a family of his own. And just like Dad had done, he put his tithing check up on the refrigerator door as soon as he was paid. ◆

The author lives in Colorado, USA.



Today at church I paid my tithing. I also decided to use almost half of my babysitting money for humanitarian aid and the general missionary fund. I remember that the prophet said that if you can’t go on a mission right now, you can send your dollars on a mission. Since I’m still young and can’t go on a mission, I will send my dollars on a mission.

**Victoria B., age 12, Alberta, Canada**





ANSWERS FROM AN APOSTLE

# How can I be a disciple of Jesus Christ?

**By Elder  
Ronald A.  
Rasband**

Of the Quorum  
of the Twelve  
Apostles

We are disciples when we act as Jesus's hands here upon the earth and serve His children.

Try sharing your love with people around you. You could call them, write them a note, or visit them.

We can all bless the lives of others.

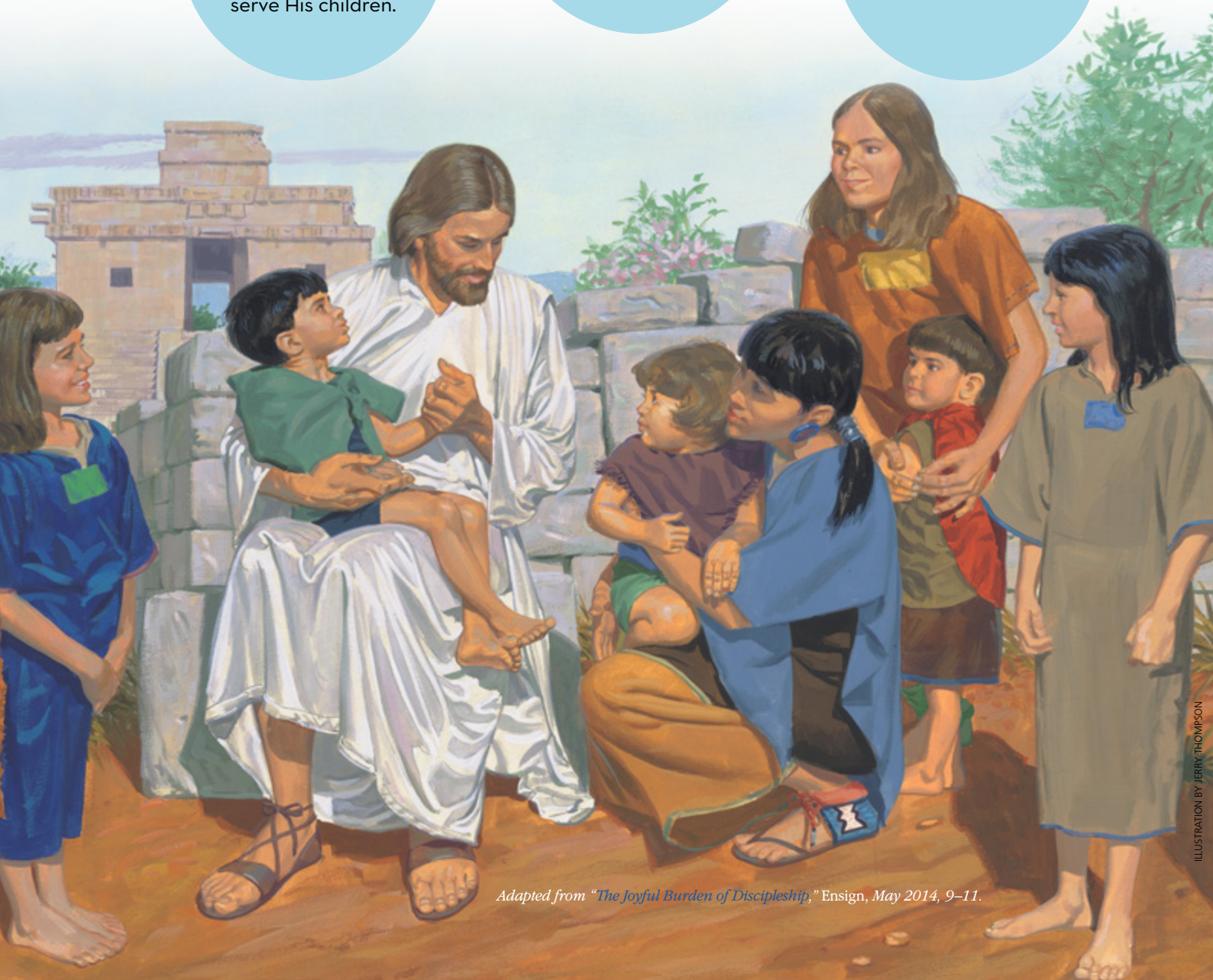

Adapted from "The Joyful Burden of Discipleship," Ensign, May 2014, 9–11.



# Meet Elder Ronald A. Rasband

He was born  
February 6, 1951.



When he was young, his mother and  
father taught him to work hard.



He learned to love the scriptures  
when he was in Primary. His teachers  
often asked him to read because he  
had a good reading voice.

He served a mission  
in the eastern United  
States. Years later  
he was called to be a  
mission president in  
New York, USA.

He was called to  
be an Apostle in  
October 2015.

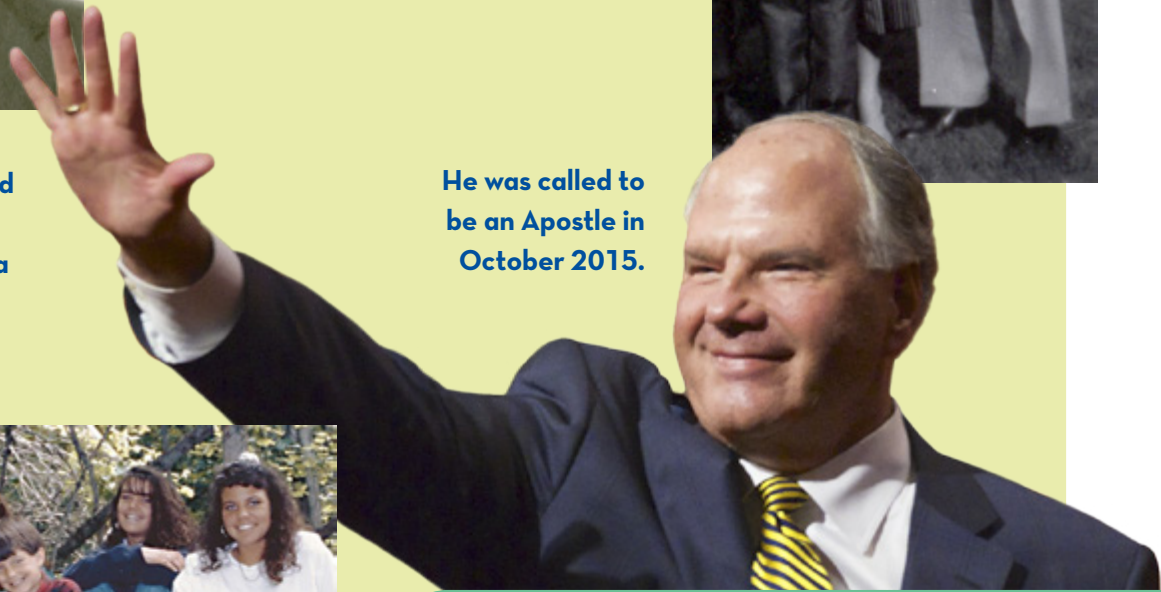

He met his wife, Melanie Twitchell, in college.  
They have five children.

## WHAT IS AN APOSTLE?

When Jesus was on the earth, He called 12 men to be His special helpers and witnesses. They were called Apostles. He has called Apostles to be His special helpers and witnesses today. They testify of Jesus Christ to the whole world. Elder Rasband is an Apostle.

# Mormon Remembered

**M**ormon was only a teenager when he was put in charge of the Nephite armies! When he was 24 years old, he wrote on metal plates about the Nephites. He also wrote the words of other prophets. He wrote about people making hard choices and about when Jesus visited the earth. Because of Mormon, we can read those stories now. Before he died, he gave the plates to his son Moroni to keep writing.



My friend's teacher is not a member of our church. I gave her a Book of Mormon with my testimony in it. I told her she should read it because it is one of my favorite books and it is really great. I know that when we share the gospel with others, we can help build Heavenly Father's kingdom on earth.

**Abi W., age 10, Utah, USA**

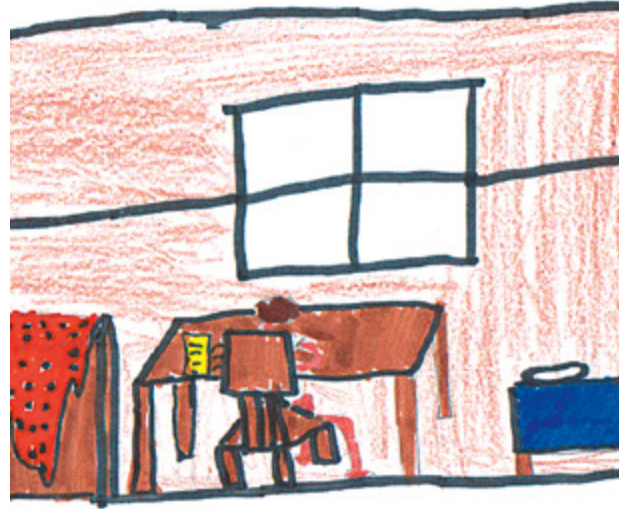

**Miles M., age 11, Arizona, USA**

ILLUSTRATIONS BY JARED BECKSTRAND



Cut, fold, and keep this challenge card!



## I CAN REMEMBER!

- Memorize [Mormon 1:15](#).
- Write in a journal about a time when you learned something about the gospel.
- Ask a parent or other family member about a time when they learned something about the gospel.
- I challenge myself to ...

---



### This Month's Scriptures

After you read a scripture passage, color the matching numbered areas on the picture!

- 1 Mormon 8:1, 4-5, 34-38
- 2 Moroni 1:1-4
- 3 Moroni 7:1-3, 12-13, 16-19
- 4 Moroni 7:41-47
- 5 Moroni 10:1-7
- 6 Moroni 10:8-19
- 7 Moroni 10:32-34
- 8 Joseph Smith—History 1:11-19, 25

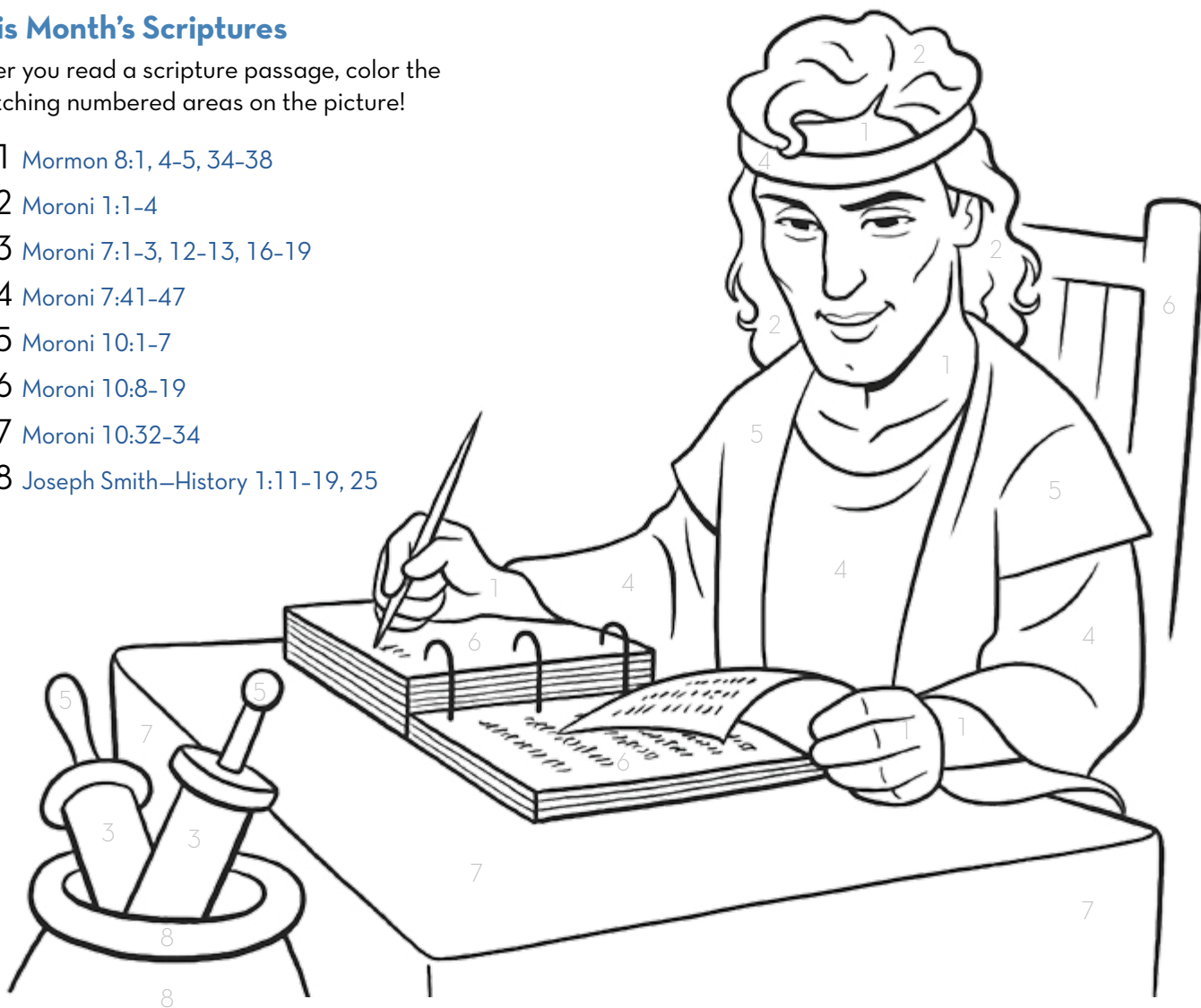

### Book of Mormon Stories

Mormon's son Moroni wrote an invitation for everyone to read the scriptures and pray to know if the words are true. He said that all good things come from Jesus Christ. Joseph Smith prayed to know what was true, and Heavenly Father and Jesus Christ visited him in the Sacred Grove. Look for another reading challenge next month!

# Ready, Set, Share-ades!

One of the fun things about learning something new is sharing it with others. Here's an activity you can do with your family to share what you learned at church.



1. Have everyone in your family bring a pencil and paper to church.



4. Have one member of the family pick a slip of paper and act out the word.

2. Write down words or ideas about what you learn.

5. The other members of the family try to guess what's being acted out. When someone guesses correctly, it's another person's turn! As you take turns, talk about what you learned about these words.



3. When you get home, write the words on slips of paper. Put them in a bowl or jar.





# Faithful Friends



By Lindee G. and Ila P., both age 11, Idaho, USA

When we play together, we bring our *Faith in God* book and scriptures. We work on our goals and help each other learn and understand things. This has helped us complete our *Faith in God* book very quickly and has helped us have fun doing the achievements together. Doing this has helped us prepare for Young Women and has strengthened our testimonies!

When we have play dates, we like to pretend that our dolls are missionary companions. Doing this helps us be missionaries now and prepares us for missions when we're older.



# Parker's **BIG** Problem

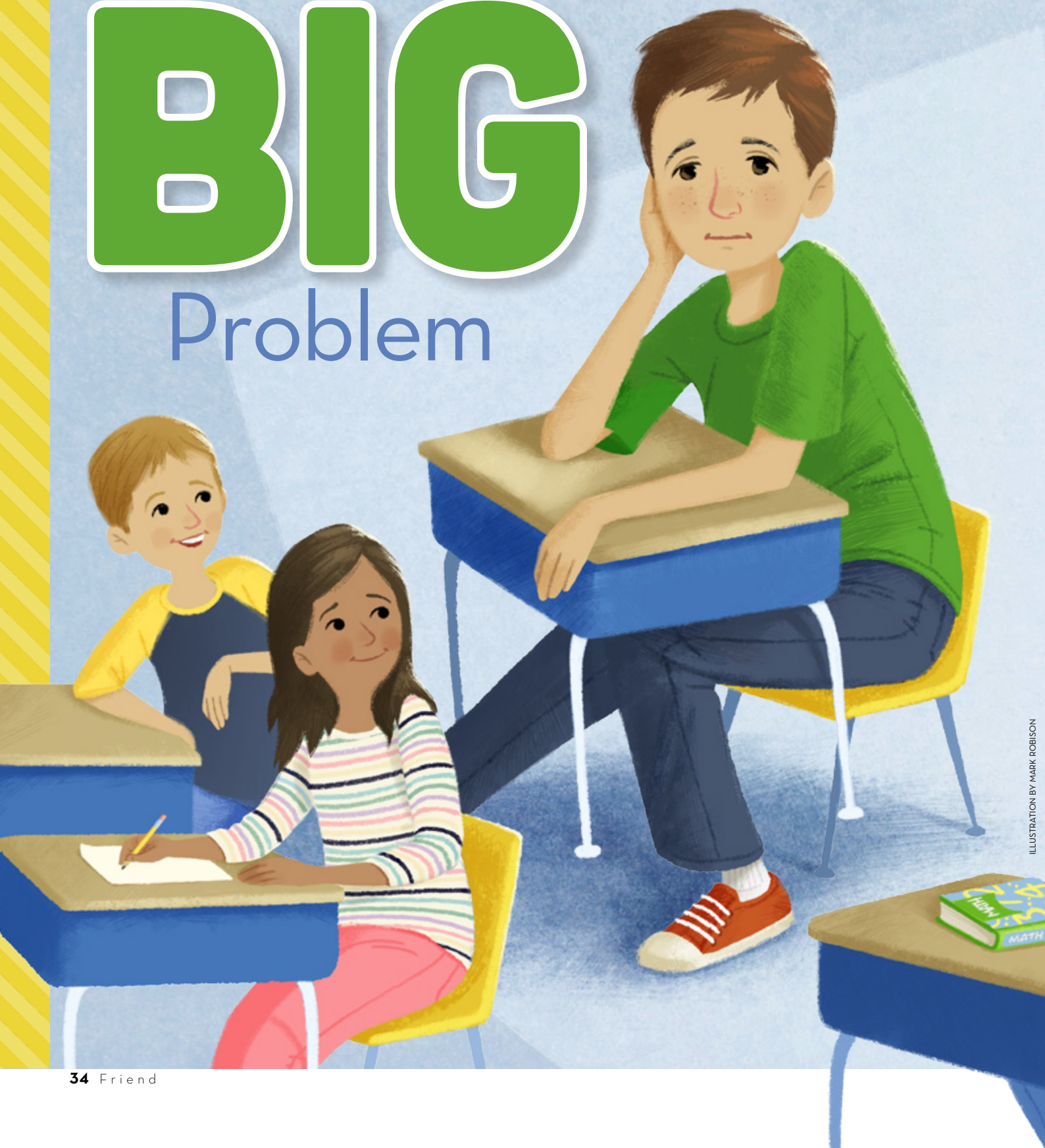

ILLUSTRATION BY MARK ROBISON



## By Breanne Richards

(Based on a true story)

*"I, Nephi, being exceedingly young, nevertheless being large in stature . . . did cry unto the Lord; and behold he did visit me" (1 Nephi 2:16).*

Parker bent his knees a little as he stood against the height chart in P.E. *Please be shorter*, he pleaded inside.

"Stand up straight," his P.E. teacher said. Parker sighed and straightened his knees.

"You've sure grown this year," his teacher said. "You're 5'9" [1.75 m]!"

Parker groaned. He'd grown another two inches (5 cm) in just the last month. Most of his friends were a *lot* shorter than he was. He was only 10! It was so embarrassing.

After P.E. Parker walked back to his classroom and sat down at his desk. His knees didn't fit underneath, and they banged loudly against the metal. The kids sitting nearby started laughing.

At recess Parker's friends played on the monkey bars. They all swung easily across. But Parker's toes dragged on the ground, and it wasn't much fun. During soccer, Parker kept tripping over himself. Everyone else ran quickly across the field.

Parker stopped and watched as they ran farther away. He sighed. Why did his body feel so *awkward*? It felt slow and clumsy.

Frustrated, Parker walked to a tetherball court and started swinging the ball around. At least *this* was easier now that he was taller and stronger. He unwound the ball and hit it harder and harder until it started swinging up toward the sky.

"Hey!" a teacher said.

"Don't hit the ball that hard. You could break the rope!"

Parker froze. He didn't think he was doing anything wrong.

Teachers always expected him to act older just because he was tall.

The bell rang to come in. His

friend Lucas waved at him on the way back from playing soccer. "Where'd you go?" he asked.

"I didn't want to play anymore, I guess," Parker said as he sat down in his chair. He almost fell over because he was so much bigger than it was.

Lucas laughed. "Hey, Parker! You're supposed to sit in the chair."

Parker felt his cheeks get red. Luckily, no one else saw. But then he saw Mrs. Warner looking at him. She started walking toward him.

"Parker," she said, "would you come with me please?"

Parker's heart started to pound. He *really* hadn't done anything wrong this time. He followed Mrs. Warner into the hallway.

"You sure have grown a lot lately," she smiled. "You're taller than I am now."

Parker frowned. "I'm sorry," he said.

Mrs. Warner's forehead wrinkled. "Sorry?" she said. "Don't ever be sorry for being tall."

Parker said, "But I'm so big now. It's awkward."

"I know it's hard," Mrs. Warner said. "When I was young, I was always the smallest kid in my class. I hated how everyone else was taller and stronger."

"Really?" Parker said. "But you're not short anymore."

Mrs. Warner laughed. "Exactly! Most of your friends are like I was. They haven't grown yet. You just beat them to it!"

*Was it really OK to be tall?* Parker wondered.

"Now, I called you out here to ask you something," Mrs. Warner said. "How do you like your chair?"

"Um, it's kind of small," he said.

She smiled. "Let's get you a bigger desk and chair."

"Thank you!" Parker said.

The next day Parker walked into his classroom. In his spot was a full-sized desk and chair. It was all the class could talk about.

"Why does Parker get a bigger desk?"

"I wish I was tall!"

"I want one!"

Parker sat down in his chair. He fit! And his knees didn't bang against it! He liked having a bigger desk. Maybe being tall wasn't so bad after all. ◆

The author lives in Utah, USA.



# It's Good to Be ME!

Trees, fruits, flowers, and animals are all different shapes, colors, and sizes. Heavenly Father made people different too! We grow at different speeds and blossom at different times. You can feel good about who you are and what makes you special. Use your answers from the questions below to draw a picture that represents you!

**If my body were a plant, I'd be a . . .**

- a. short bonsai
- b. tall redwood
- c. round cactus
- d. wispy willow

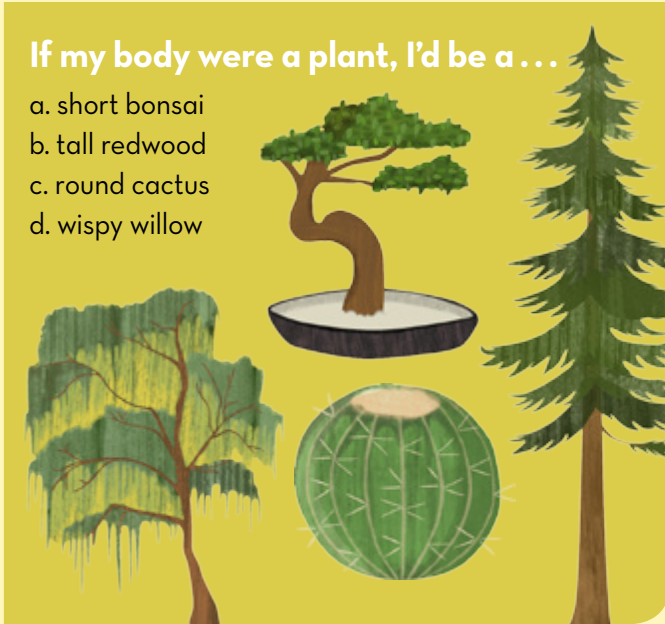

**Thinking about flowers, my hair is most like a . . .**

- a. yellow dandelion
- b. brown cattail
- c. black hollyhock
- d. orange poppy



**When it comes to friends, I . . .**

- a. hang with a bunch, like a banana
- b. am fine solo, like a watermelon
- c. stick with a buddy, like a cherry
- d. love attention, like a dragon fruit



**Out of all these animals, I'm most like a . . .**

- a. sleepy sloth
- b. galloping horse
- c. flying canary
- d. swinging monkey



Here are pictures from some of us at the *Friend*—now send us what you drew! Turn to page 39 to see how.

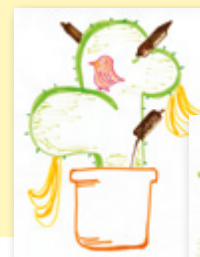
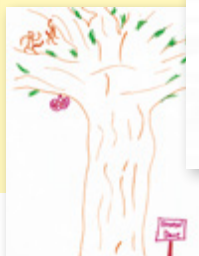



# Puzzle Time!

What's the absolute best thing you can put into a pie? To find out, fill in the boxes that contain letters in the word "GIVING." Then write the remaining letters from left to right in the blanks provided.

G N Y I V O U V G N R I T I E V G E T N H



-----

## Modern-day MYSTERY

Samantha was reading in her journal and came across this entry: "Two days ago, I was 8 years old. Next year, I can't wait to turn 11!" She didn't make a mistake in her math. How is this possible?

Answer on page 39.

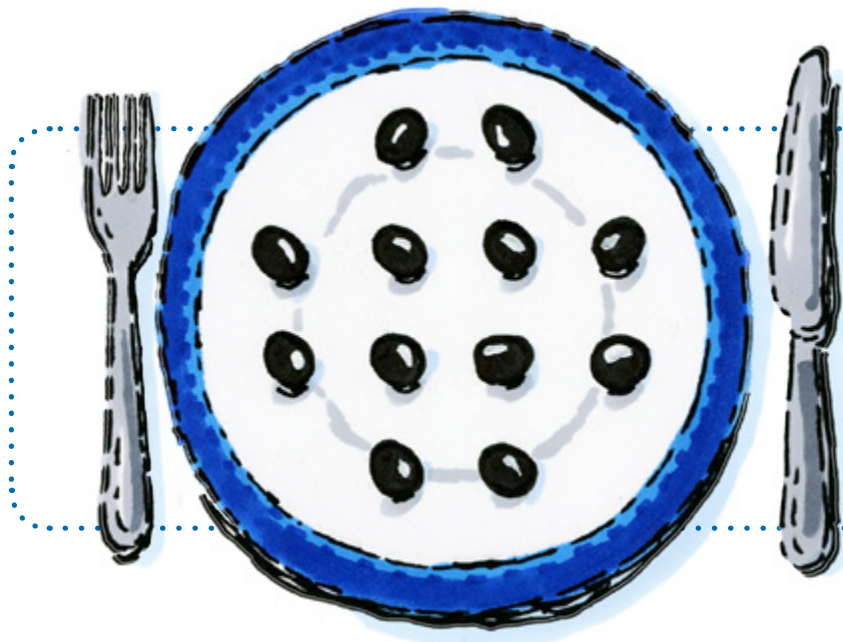
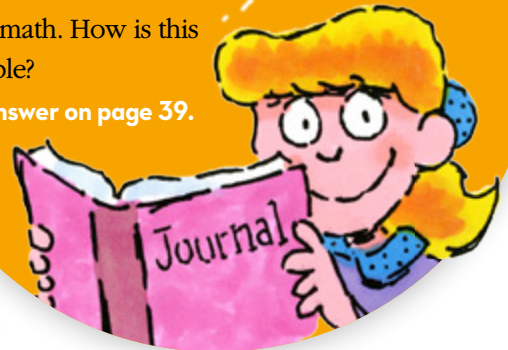

## Olive Squares

Carter has arranged his olives on his plate in a most spectacular way! How many squares can you make by connecting lines between the olives? Hint: not all squares are the same size, and think diagonally!

Answer on page 39.





# MATT AND MANDY

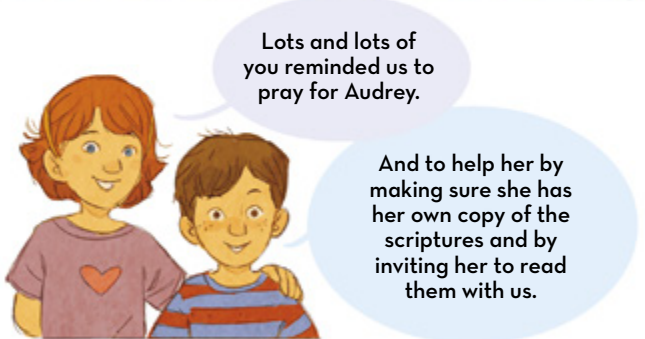
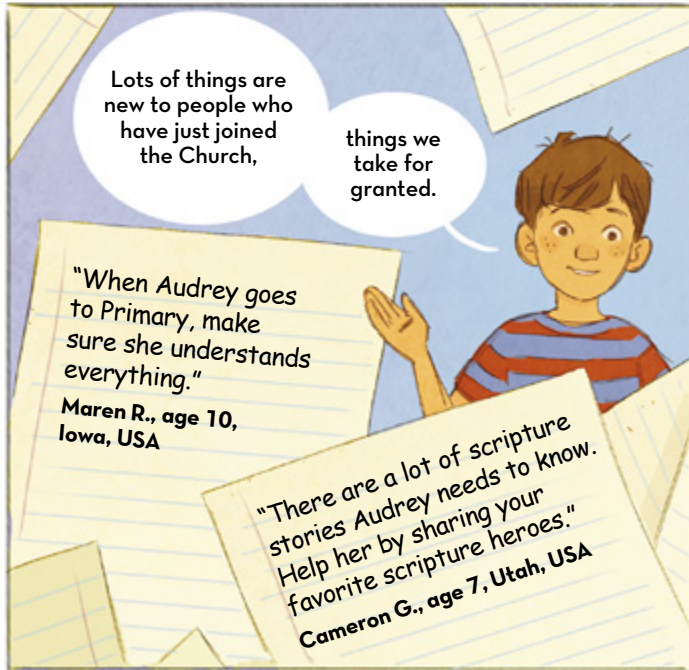
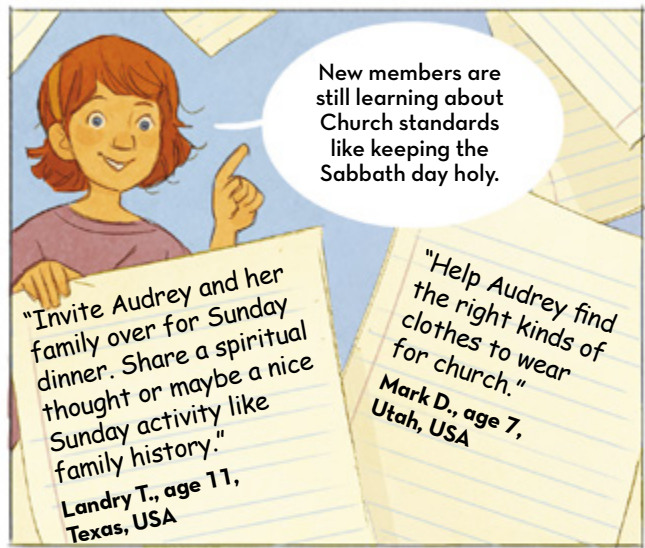
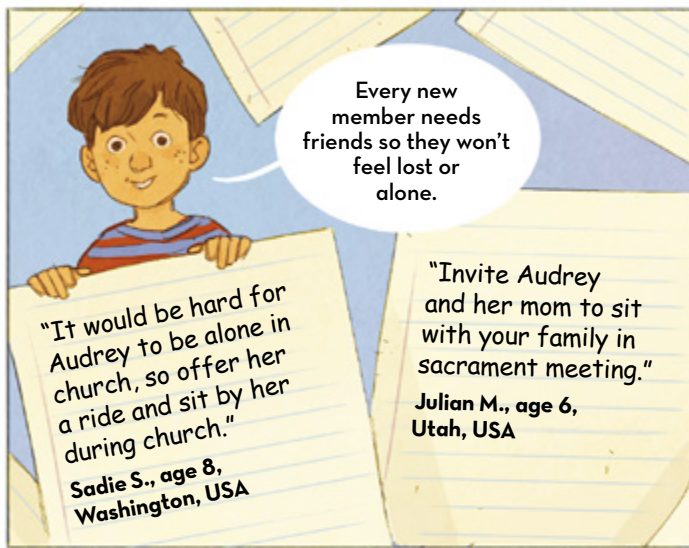



## FUNSTUFF ANSWERS

**Page 15:** 1-Nephi, 2-Abinadi, 3-Abish, 4-Ammon, 5-Captain Moroni, 6-Moroni; house, arms, title of liberty, Isaiah, fire; faith

**Page 37:** your teeth; Samantha's journal entry was written on Janu-

ary 1. The day before, December 31, was her 9th birthday. This year she'll turn 10 on December 31, and next year she'll turn 11 on December 31; Carter can make 11 squares: 2 big, 4 medium, and 5 little.



## HIDDEN CTR RINGS

Did you find the rings? Look on pages FJ1 and 24. The October level 3 ring was on page 17.

## Through Your Eyes

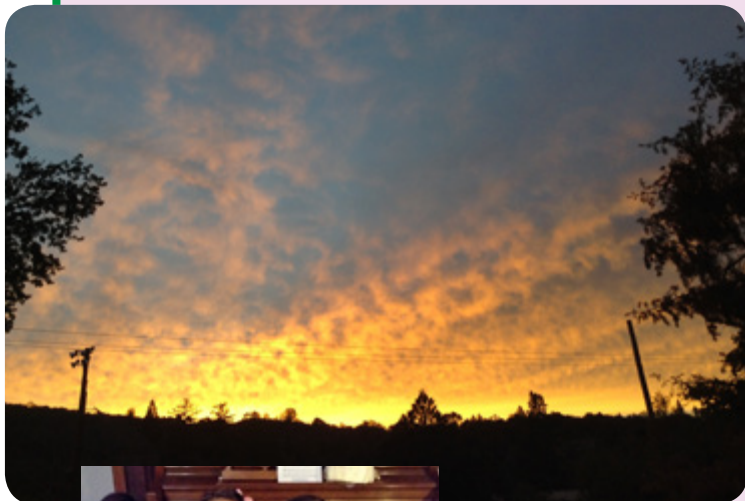

*One morning our mom woke us up early and was excited to show us this gorgeous sunrise. We are so grateful Heavenly Father makes the most beautiful scenery just to make us happy!*

**Josie, Vivian, Mariel, and Natalie F., ages 9, 11, 11, and 6, California, USA**

## How to Write to the Friend

To send us a letter, drawing, or poem...

1. Fill out the form below and send it in with your story or artwork.
2. Send a school picture or other high-resolution photo.
3. We might edit your submission for length or clarity, and we can't return it to you.
4. You must be at least three years old.

Please send your submission to:

**Friend Magazine**  
50 E. North Temple St., Rm. 2393  
Salt Lake City, UT 84150-0024  
Or email: [friend@ldschurch.org](mailto:friend@ldschurch.org)

May the Friend contact you with a survey?

Yes  No

The following information and permission must be included:

First and last name \_\_\_\_\_

Age \_\_\_\_\_ Boy/Girl \_\_\_\_\_ State/Province, Country \_\_\_\_\_

**I give my permission to The Church of Jesus Christ of Latter-day Saints to use my child's submission and photo on the Church websites and social media platforms as well as for Church reports, print products, video, publications, and training materials.**

Signature of parent or legal guardian \_\_\_\_\_

Email of parent or legal guardian \_\_\_\_\_



To read more, close the magazine and flip it over!

Wouldn't it be faster to, you know, just carry your laundry upstairs?







# THE *Friend* JUNIOR



# For Parents of Little Ones



## Four ways to build happy sibling relationships:

■ Quell jealousy. Sometimes the older child has to wait while you feed or change the baby. Remember to turn it around sometimes too: “Baby, you’re going to have to wait on your blanket for a minute while I help your brother.” Baby won’t understand, but brother will.

■ Provide an example. Display a picture of Jesus in your home and explain that He is our Elder Brother. He can teach us everything we need to know about loving our family.

Looking forward to becoming an older brother or sister can be exciting. And then baby arrives and isn’t all that playful. Envy kicks in, and before you know it, big sister asks how long baby sister is staying!

The gift and challenge of siblings is one way Heavenly Father helps young children grow. You might expect some meltdowns as your oldest deals with mixed feelings. But a few nudges from you can help them rise to their new role.



■ Recruit an ally. Give your older child jobs, like policing the family’s noise level during naptime or fetching bath-time supplies. If sister has responsibilities, she’ll feel important instead of stifled by all the changes.

■ Practice, practice, practice! Ask brother to practice teaching his teddy bears to eat with a spoon, give gentle hugs, smell flowers, or read board books. Then he’ll be ready to teach when baby is ready to learn. Help him now to see his valued place as a mentor.

You can read past letters at [FriendFPLO.lds.org](http://FriendFPLO.lds.org).







“Thanks to our Father we will  
bring, for He gives us everything.”  
—Children’s Songbook, 20

# Big Sister Madelyn

By Jennifer Maddy



Mommy

sniffed and coughed. She blew her



nose



Madelyn

. “I am sick.

I need your help with baby



Jason

today.”



Madelyn

wanted to be a good

helper. She held baby



Jason

carefully and gave him a



bottle

. She made



Jason

laugh and



smile

while



Mommy

changed his



diaper

. When



Jason

wiped



carrots

all over his face



Madelyn

cleaned him with a soft



towel

While



Jason

was napping,



Mommy

had a rest too.



Madelyn

brought her

a



blanket

. “Thank you for helping today!”



Mommy

said.



Madelyn

smiled.

She liked being Big Sister



Madelyn

!



# Little or Big

Find the things that are the right size for a baby brother or sister.  
Then find the things that are the right size for you.



# Mormon Writes on the Golden Plates



Many prophets wrote on the golden plates. They wrote about Jesus Christ and about how to keep the commandments. But many people forgot Jesus Christ and didn't follow Him anymore.



A righteous man named Ammaron hid the golden plates so they would be safe. He told a boy named Mormon where the plates were hidden. He told Mormon to write on the plates when he was older.



When Mormon was 15 years old, Jesus Christ visited him and taught him about the gospel. Mormon tried to teach the people about Jesus, but they wouldn't listen.

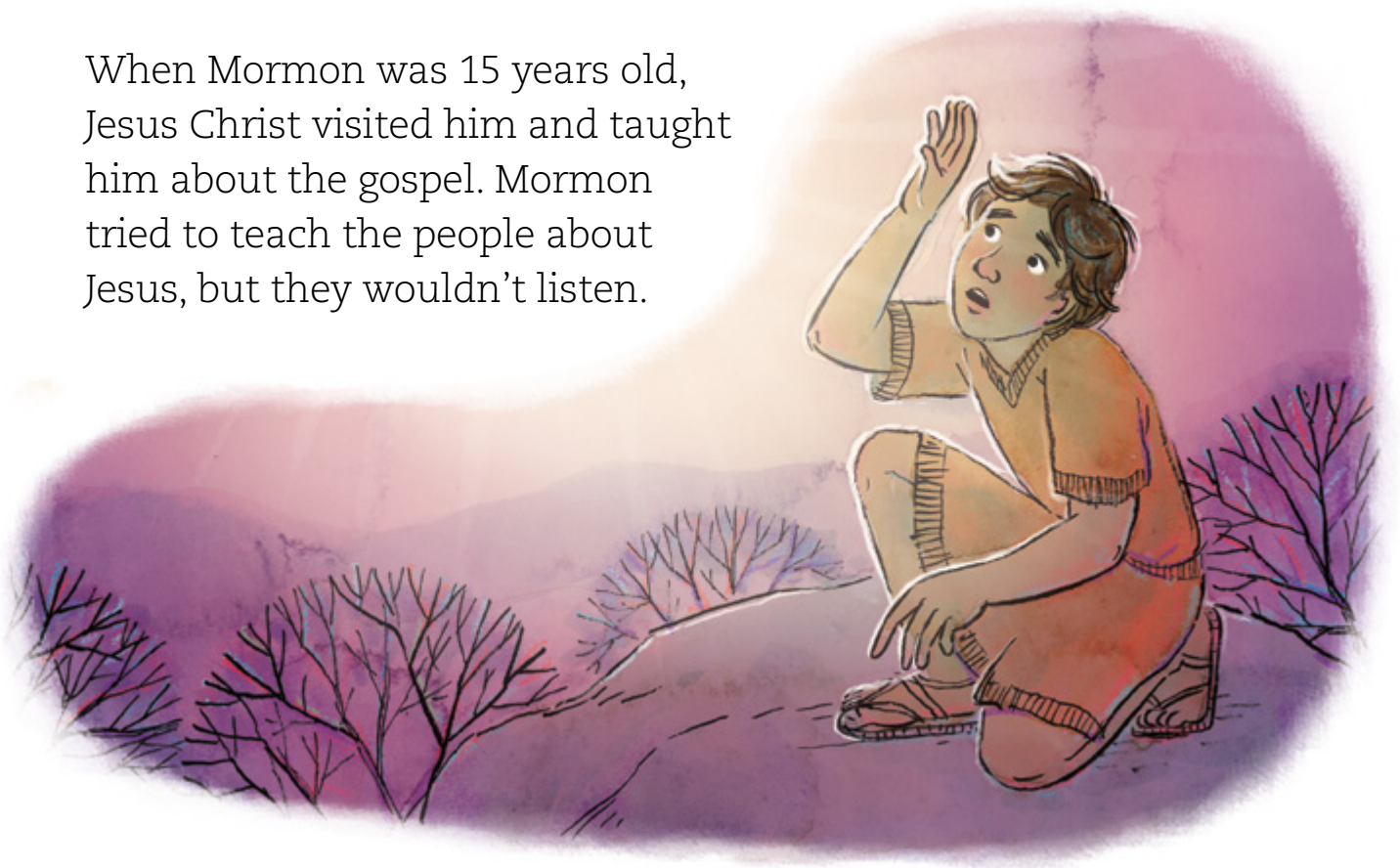

When Mormon got older, he got the plates. He wrote about Jesus Christ. He wrote that we can repent, be baptized, and receive the Holy Ghost.







Mormon had a son named Moroni. Mormon told his son to always remember how much Jesus Christ loves us. We can remember how much Jesus loves us too! ◆

*From Mormon 1, 9*



COLORING PAGE

# I Can Show Love for Animals



ILLUSTRATION BY APRYL STOTT

**By Holly Carter**

(Based on a true story)

**H**enry and his friends were excited to visit a farm.

First they played in the pumpkin patch. "Look at that big pumpkin!" Henry called.

"And there's a little baby one!" Adalynn said.

Then they went to see the goats and chickens. "The chicks are so fuzzy," Peyton said.

Next it was time to ride the train. "All aboard!" Mom said.

The train chugged past horses and apple trees. It chugged past a big roll of hay that looked like a pig.

The train stopped at the corn maze.

"Hooray!" Henry said. This was the best part.

They followed a sign into the corn maze. Trails were everywhere. Some trails led to other trails. Some trails just ended. Henry and his friends walked and walked.

After a while, they all felt tired. "How do we get out of the maze?"

Henry asked.

"I'm not sure," Mom said.

Henry couldn't see over the corn stalks. His heart beat fast. Maybe they were lost!

"Let's say a prayer," Mom said.

"OK," Henry said. He bowed his head. "Heavenly Father, please help us get out of the corn maze." After he said, "Amen," Henry felt warm and happy.

Soon Henry heard someone shout, "Here's the way out!"

**Henry and the**

Henry knew  
Heavenly Father  
helped them.

At bedtime, Henry said a prayer. He thanked Heavenly Father for helping him.

He smiled. It felt good to know that Heavenly Father loved him. And that Heavenly Father could always hear him pray, even in a corn maze! ◆

The author lives in Alabama, USA.



# Corn Maze

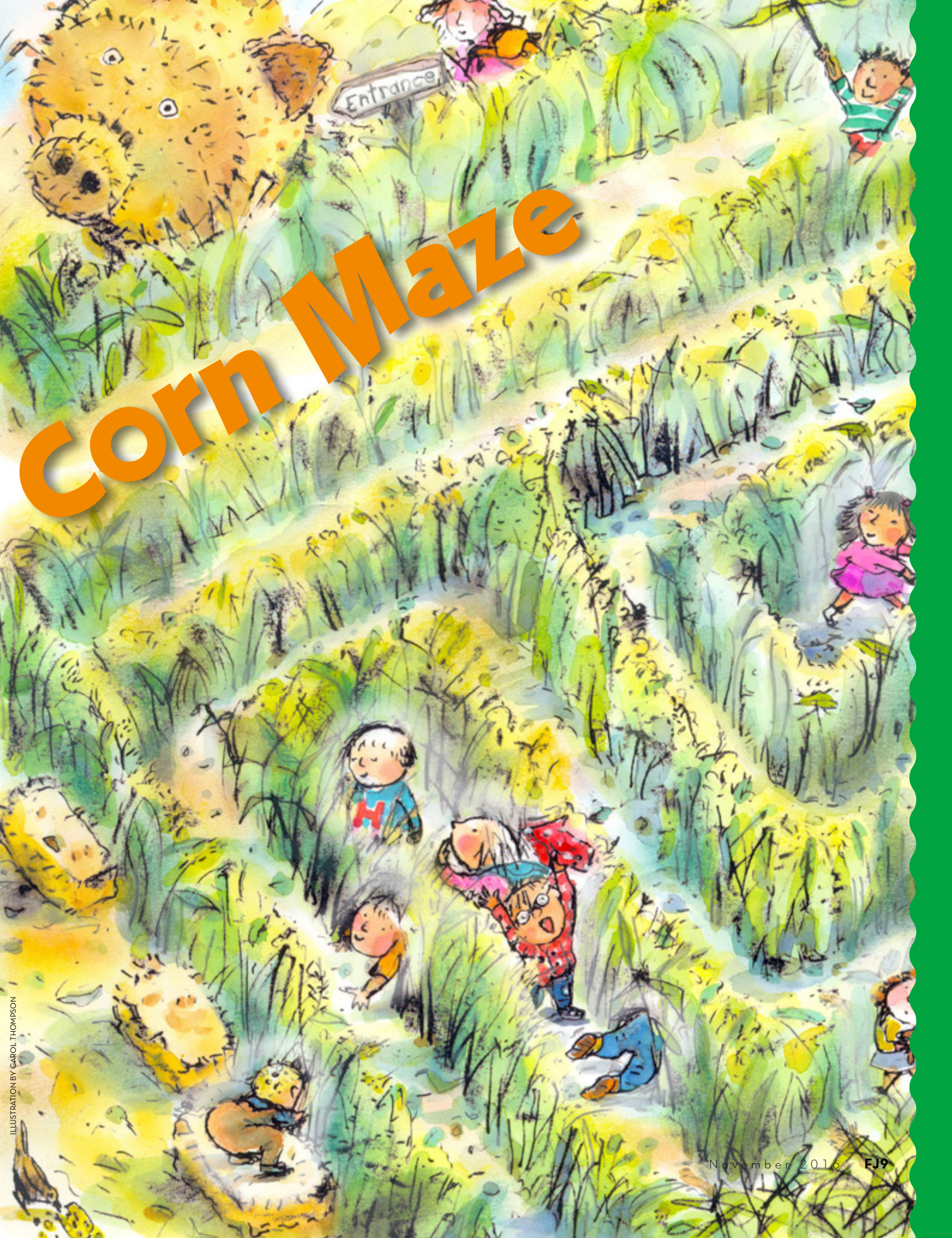

ILLUSTRATION BY CAROL THOMPSON