



NEW TESTAMENT 2019

Come, Follow Me— For Primary

Living, Learning, and Teaching the Gospel of Jesus Christ

NEW TESTAMENT 2019

Come, Follow Me— For Primary

Living, Learning, and Teaching the Gospel of Jesus Christ

© 2019 by Intellectual Reserve, Inc.
All rights reserved.
Printed in the United States of America

English approval: 2/17

Contents

You Are a Teacher of Children.	v
Using <i>Come, Follow Me—For Primary</i>	vi
Additional Resources for Teaching Children.	viii
Meeting the Needs of Younger Children.	ix
A Pattern for Teaching	xi
December 31–January 6: We Are Responsible for Our Own Learning	1
January 7–13: Matthew 1; Luke 1	5
January 14–20: Luke 2; Matthew 2.	9
January 21–27: John 1	13
January 28–February 3: Matthew 3; Mark 1; Luke 3	17
February 4–10: Matthew 4; Luke 4–5	21
February 11–17: John 2–4.	25
February 18–24: Matthew 5; Luke 6	29
February 25–March 3: Matthew 6–7	33
March 4–10: Matthew 8–9; Mark 2–5.	37
March 11–17: Matthew 10–12; Mark 2; Luke 7; 11	41
March 18–24: Matthew 13; Luke 8; 13.	45
March 25–31: Matthew 14–15; Mark 6–7; John 5–6	49
April 1–14: Matthew 16–17; Mark 9; Luke 9	53
April 15–21: Easter	57
April 22–28: Matthew 18; Luke 10	61
April 29–May 5: John 7–10	65
May 6–12: Luke 12–17; John 11	69
May 13–19: Matthew 19–20; Mark 10; Luke 18	73
May 20–26: Matthew 21–23; Mark 11; Luke 19–20; John 12	77
May 27–June 2: Joseph Smith—Matthew 1; Matthew 25; Mark 12–13; Luke 21	81
June 3–9: John 13–17	85
June 10–16: Matthew 26; Mark 14; Luke 22; John 18	89
June 17–23: Matthew 27; Mark 15; Luke 23; John 19	93
June 24–30: Matthew 28; Mark 16; Luke 24; John 20–21	97
July 1–7: Acts 1–5.	101
July 8–14: Acts 6–9.	105
July 15–21: Acts 10–15	109
July 22–28: Acts 16–21	113
July 29–August 4: Acts 22–28.	117

August 5–11: Romans 1–6	121
August 12–18: Romans 7–16	125
August 19–25: 1 Corinthians 1–7	129
August 26–September 1: 1 Corinthians 8–13	133
September 2–8: 1 Corinthians 14–16	137
September 9–15: 2 Corinthians 1–7	141
September 16–22: 2 Corinthians 8–13	145
September 23–29: Galatians	149
September 30–October 13: Ephesians	153
October 14–20: Philippians; Colossians	157
October 21–27: 1 and 2 Thessalonians	161
October 28–November 3: 1 and 2 Timothy; Titus; Philemon	165
November 4–10: Hebrews 1–6	169
November 11–17: Hebrews 7–13	173
November 18–24: James	177
November 25–December 1: 1 and 2 Peter	181
December 2–8: 1–3 John; Jude	185
December 9–15: Revelation 1–11	189
December 16–22: Christmas	193
December 23–29: Revelation 12–22	197

Feel free to adapt the schedule to account for Sundays when regular Church meetings are not held. For example, you could cover two weeks of outlines in one Sunday lesson when ward or stake conferences or temple dedications are held. You may also need to adapt the study schedule if in your area Easter and Christmas are observed on dates other than those listed in this resource.



You Are a Teacher of Children

You have been called of God to teach His children in the Savior's way. You were set apart to this calling by the authority of His holy priesthood. Even if you are not an experienced teacher, as you live worthily, pray daily, and study the scriptures, God will grant you the influence and power of the Holy Spirit (see 2 Nephi 33:1).

Those entrusted to your care are Heavenly Father's children, and He knows what they need and how best to reach them. Through the Holy Ghost, God will guide you during your preparation and while you are teaching. He will reveal to you what you should say and what you should do.

In all aspects of their lives, these precious children are constantly absorbing information, forming and refining their opinions, and making and sharing discoveries. This is especially true with the gospel, for children are

ready and eager to learn its simple truths. Their faith in spiritual things is strong and pure, and they see every moment as a learning moment. They willingly act on what they have learned, even if their understanding is still incomplete. This is how we should all receive the gospel. As the Savior taught, "Whosoever shall not receive the kingdom of God as a little child shall in no wise enter therein" (Luke 18:17).

The calling to teach children is a sacred trust. It is normal to feel overwhelmed at times. But remember that your Heavenly Father called you, and He will never forsake you. This is the Lord's work, and as you serve "with all your heart, might, mind and strength" (D&C 4:2), He will enlarge your capacities, gifts, and talents, and your service will bless the lives of the children you teach.



Using *Come, Follow Me—For Primary*

Preparing to Teach in Primary

The home should be the center of gospel learning. This is true for you and for the children you teach. As you prepare to teach, start by having your own experiences in the scriptures. Your most important preparation will occur as you seek the inspiration of the Holy Ghost.

Come, Follow Me—For Individuals and Families is also an important part of your preparation. It will help you gain a deeper understanding of the doctrinal principles found in the scriptures.

During your preparation, thoughts and impressions will come to you about the children you teach. You will receive insights into how the principles in the scriptures will bless their lives. You will be guided to inspire them to discover those principles as they learn from the scriptures for themselves and with their families. Remember to be sensitive to children whose family circumstances may not support regular family scripture study.

Teaching Ideas

As you are preparing to teach, you might gain additional inspiration by exploring the outlines in this resource. Don't think of these ideas as step-by-step

instructions but rather as suggestions to spark your own inspiration. You know these children, and the Lord knows them too—including what they need and what they can understand. He will inspire you with the best ways to teach and bless the children.

You have many other resources available as you prepare, including ideas in *Come, Follow Me—For Individuals and Families* and Church magazines. For more information about these and other resources, see “Additional Resources for Teaching Children.”

Some Things to Keep in Mind

- Parents have the main responsibility to teach their children. As a teacher, you have an important responsibility to support, encourage, and build upon gospel learning in the home. Be sensitive to children whose parents do not teach the gospel in their home. Include all children in gospel discussions regardless of their home circumstances.
- Repetition is good. Children learn gospel truths more effectively when these truths are taught repeatedly through a variety of activities. If you find that a learning activity is effective with the children, consider repeating it, especially if you are teaching

younger children. You might also review an activity from a previous lesson.

- Heavenly Father wants you to succeed as a teacher. He has provided many resources to help you succeed, including teacher council meetings. In these meetings you can counsel with other teachers about any challenges you might face. You can also discuss and practice principles of Christlike teaching.
- If you are teaching younger children and need additional help, see “Meeting the Needs of Younger Children” in this resource.
- This resource includes outlines for every week of the year except for the two Sundays when general conference is held. On Sundays when Primary is not held because of stake conference or any

other reason, families may continue reading the New Testament at home according to the schedule outlined. In order to keep your Primary class on schedule, you may choose to skip a lesson or combine two lessons. To avoid confusion, Primary presidents may wish to advise teachers about these adjustments ahead of time.



Additional Resources for Teaching Children

All of these resources can be found on LDS.org and in the Gospel Library app.

Come, Follow Me— For Individuals and Families

You can adapt any activities from this resource for use in your Primary class. Even if parents are using these activities with their children at home, repetition can be a useful way to help children learn. Children may want to tell you about how they did the activities with their families and what they learned.

Behold Your Little Ones: Nursery Manual

Many of the topics taught in the nursery manual are similar to those you will teach in Primary. Especially if you teach younger children, consider looking in the nursery manual for additional songs, stories, activities, and crafts.

Friend and Liahona magazines

The *Friend* and *Liahona* magazines provide stories and activities that can supplement the principles that you are teaching from *Come, Follow Me—For Primary*.

Hymns and the Children’s Songbook

Sacred music invites the Spirit and teaches doctrine in a memorable way. In addition to the print versions of *Hymns* and the *Children’s Songbook*, you can find audio and video recordings of many hymns and children’s songs at music.lds.org or in the LDS Music App.

New Testament Stories

New Testament Stories (2005) can help children learn the doctrine and stories found in the New Testament. You can also find videos of these stories at medialibrary.lds.org.

Media Library

Artwork, videos, and other media can help you and the children visualize the doctrine and stories found in the New Testament. Visit medialibrary.lds.org to browse the Church’s collection of media resources, including the Bible Videos series, which depicts events in the New Testament.

Gospel Art

Artwork can help the children visualize the doctrine and stories found in the New Testament. Many images that you can use in class are found in the *Gospel Art Book* and at medialibrary.lds.org.

Lesson Helps for Teaching Children

At lds.org/children/resources you can find an index of magazine articles, activities, and media on a variety of gospel topics.

True to the Faith

If you need additional help understanding the basic principles you will teach the children, consider looking in *True to the Faith* (2004). This reference provides simple explanations of gospel topics, listed in alphabetical order.



Teaching in the Savior’s Way

This resource can help you learn about and apply principles of Christlike teaching. These principles are discussed and practiced in teacher council meetings.



Meeting the Needs of Younger Children

Little children are ready and eager to learn the gospel if it is presented in a way they can understand. If you teach younger children, consider these activities that can help them to learn (some older children may also benefit from these activities):

- *Listen to or act out a story.* Young children love stories—from the scriptures, from your life, from Church history, or from Church magazines. Look for ways to involve them in storytelling. They can hold pictures or objects, draw pictures of what they are hearing, act out the story, or help tell the story. Help children recognize the gospel truths in the stories you share.
- *Read a scripture.* Young children may not be able to read very much, but you can still engage them in learning from the scriptures. You may need to focus on a single verse, key phrase, or word. As you read a scripture out loud, you could invite children to stand up or raise their hands when they hear a specific word or phrase you want to focus on. They may even be able to memorize short phrases from the scriptures if they repeat them a few times. As they hear the word of God, they will feel the Spirit.
- *Be active.* Because young children are often energetic, plan ways to let them move around—marching, jumping, skipping, bending, walking, and other actions that relate to the principle or story you are teaching. These actions can also be effective as you sing together.

- *Look at a picture or watch a video.* When you show children a picture or video related to a gospel principle or scripture story, ask them questions that help them learn from what they are seeing. For example, you could ask, “What is happening in this picture or video? How does it make you feel?” Biblevideos.lds.org, medialibrary.lds.org, and children.lds.org are good places to look for videos.
- *Sing.* Hymns and songs from the *Children’s Songbook* teach doctrine powerfully. Use the topics index at the back of the *Children’s Songbook* to find songs that relate to the gospel principles you are teaching. Help the children relate the message of the songs to their lives. For example, you might ask questions about words or phrases in the lyrics. In addition to singing, children can do actions that go with the songs or just listen to the songs as background music while they are doing other activities.
- *Share experiences.* Young children may not have as much to share as older children do, but if you give them specific guidance, they can share their feelings and experiences about what they are learning.

- *Create.* Children can build, draw, or color something related to the story or principle they are learning. Encourage them to take their creation home and share it with family members to help the children remember what they learned.
- *Participate in object lessons.* A simple object lesson can help children understand a gospel principle that is difficult to comprehend. When using object lessons, find ways to let the children participate. They will learn more from an interactive experience than from just watching a demonstration.
- *Role-play.* When children role-play a situation they will likely encounter in real life, they are better able to understand how a gospel principle applies to their lives.
- *Repeat activities.* Young children may need to hear concepts multiple times to understand them. Don't be afraid to repeat stories or activities often, even during the same lesson. For example, you might share a scripture story several times in different ways during a lesson—reading from the scriptures, summarizing in your own words, showing a video, letting the children help you tell the story, inviting them to act out the story, and so on. If an activity used in class is also repeated at home, the repetition will help the children learn and remember.
- *Interact with others.* Children are developing social skills and often enjoy learning and playing with their peers. Create opportunities for them to share, take turns, and cooperate while they learn.
- *Participate in a variety of activities.* Young children typically have short attention spans, and they have

different learning styles. Use a variety of activities, and pay attention to signs that the children need a change of pace. For example, you may need to alternate frequently between quiet and lively activities.

Part of your role as a teacher of young children—in addition to teaching gospel principles—is to help the children learn how to participate appropriately in a Church class. For example, they may need to learn about taking turns, sharing, respecting others, and so on. Some teachers create charts with an assignment for each child to participate in the class in a specific way (such as by saying a prayer, holding a picture, or passing out papers). The assignments can change each week. This helps the children take turns and focus on appropriate classroom behavior.

Children—especially younger children—often benefit from a regular, predictable routine. Because young children have short attention spans and sometimes struggle to focus for an entire class, it's usually best if this routine includes frequent transitions from one type of activity to another. For example, your class routine might include occasional breaks to play a game, color a picture, sing a song, and so on.





A Pattern for Teaching

In this resource, you will find the following pattern repeated in each outline: invite sharing, teach the doctrine, and encourage learning at home. In many cases, as you teach, the elements of this pattern may overlap or occur in a different order. For example, consider that sharing is an opportunity to teach the doctrine, and teaching doctrine should involve invitations to share. Likewise, encouraging learning at home can happen throughout a class discussion. Allow this overlap to happen naturally, following the promptings of the Spirit to meet the needs of the children you teach.



Invite Sharing

As part of every class, invite the children to share their feelings, insights, and experiences about the principles in the outline. Their comments may include experiences they have had learning at home. You might also review what they learned last week and ask how it has influenced their lives.



Teach the Doctrine

Come, Follow Me—For Individuals and Families can help you understand the doctrine you will teach to the children. Consider what scripture verses, quotations, experiences, questions, and other resources you might share to help the children learn and act on gospel principles. Look for creative ways to help them be excited about what they are learning.



Encourage Learning at Home

Because the home is the center of gospel learning, one of your objectives as a Primary teacher is to encourage learning at home. How can you help the children share with their families what they learned in class? How can you encourage children and their parents to continue to learn from the New Testament at home?



DECEMBER 31–JANUARY 6

We Are Responsible for Our Own Learning

As you read the scriptures in this outline, record any spiritual impressions you receive. You will notice that each outline in this manual has activities for younger children and older children, but you can adapt any activity for your class.

RECORD YOUR IMPRESSIONS _____



Invite Sharing

At the beginning of each class, give the children opportunities to share what they are learning about the gospel. For example, this week you could invite them to share their favorite stories about Jesus Christ.



Teach the Doctrine

Younger Children

Jesus Christ wants me to follow Him.

You and the children will read many stories from the life of Jesus Christ this year. Help the children understand that the reason we are learning these stories is so that we can better follow Jesus Christ's perfect example.

Possible Activities

- Read the Savior's invitation, "Come, follow me," found in Luke 18:22. Play a game where one child

does an action and then tells the other children, "Come, follow me." Invite the other children to repeat the action.

- Show pictures of people following the Savior in different ways, during His mortal ministry and in our day. You can find pictures in the *Gospel Art Book* or Church magazines. You can also show the video "Light the World" (LDS.org). Let the children identify how the people are following the Savior.
- Help the children think of things they are doing to follow the Savior. Singing "Seek the Lord Early" (*Children's Songbook*, 108) could give them some ideas. Let them draw pictures of themselves doing these things.

The scriptures are true.

Children can gain a testimony that the scriptures are true even before they are able to read them. As you study the scriptures with the children this year, you can help them know for themselves that the scriptures are true.

Possible Activities

- Invite the children to tell about favorite gifts they have received for birthdays or other occasions. Bring a gift-wrapped copy of the scriptures, let a child open it, and testify that the scriptures are a gift to us from Heavenly Father.
- Show the children some books containing fictional stories, and ask them about their favorite stories. Show them the scriptures, and testify that the scriptures contain the word of God for us and tell of people who really lived and events that really happened.
- Share the messages found in 2 Timothy 3:15 and Moroni 10:3–5, helping the children to repeat a few phrases. Help them understand that they can know the scriptures are true for themselves.
- Hide a picture of the Savior, and give the children clues to help them find it. Help the children understand how searching the scriptures can help us know Jesus Christ. Let the children take turns hiding the picture and giving clues to other children.
- Sing together “Seek the Lord Early” and “Search, Ponder, and Pray,” *Children’s Songbook*, 108–9, and help the children make up actions to go with the words. Share with the children one or two of your favorite scriptures, and tell them how you came to know the scriptures are true. If the children have favorite scriptures or scripture stories, invite them to share.



Children can gain their own testimonies of scriptural truths.



Teach the Doctrine

Older Children

Jesus Christ wants me to learn about Him and follow Him.

Think about how you have come to know Jesus Christ. What can you do to help the children learn about and follow Him?

Possible Activities

- Invite the children to talk about a close friend they know and describe how this person became a friend. Read and discuss John 5:39 and John 14:15 to find ways we can feel close to Jesus. Ask the children to share times when they felt close to Him.
- Take your class on a walk around the meeting-house. Invite the children to raise their hands when they see something on the walk that reminds them of a way they can follow the Savior (such as the baptismal font or a picture).
- Sing with the children “Come, Follow Me,” *Hymns*, no. 116. Invite the children to share times when they have followed the Savior’s example.

I can study the scriptures for myself.

As you read the scriptures with the children and ask them questions, you can build their confidence that they can learn from the scriptures and find valuable treasures of knowledge.

Possible Activities

- Read aloud John 5:39 and Acts 17:10–11, and ask the children what they learn about how to study the scriptures.
- Select a few simple, powerful scriptures from the New Testament, write each on a piece of paper, and hide the papers. Create clues that will lead the children on a “treasure hunt” within the classroom or church building to find these scriptures. After

they find each scripture, discuss what the scripture means and why it is such a treasure.

- Share a few scriptures you treasure and explain why they are meaningful to you. As a class, keep a list of treasured scriptures the children find in the New Testament this year—at home or during Primary.
- Have a discussion with the children about why it is sometimes hard to read the scriptures. Ask the children to share advice with each other about studying the scriptures. Ask them also to share any positive experiences they have had with the scriptures.
- Help the children make simple calendars that they can use to mark how often they read the scriptures. These calendars could remind them to read the scriptures every day.

I need my own testimony.

The children you teach will need their own testimonies if they are to keep their faith strong when adversity comes. What can you do to inspire them to learn the truth for themselves?

Possible Activities

- Share the story of the ten virgins (see Matthew 25:1–13; see also “Chapter 47: The Ten Virgins,”

New Testament Stories, 118–20, or the corresponding video on LDS.org). Ask the children: How are our testimonies like the lamps? Why is it important to have our own testimonies?

- Discuss what we can do to strengthen our testimonies. For ideas, invite the children to search John 7:17 and Moroni 10:3–5. Invite them to share things they know are true.
- Ask the children to help you label building blocks with phrases that describe things we do to build our testimonies, such as praying. Let the children build a structure representing a testimony using the blocks.



Encourage Learning at Home

How can you encourage children and their parents to learn from the New Testament at home? For example, you could encourage the children to memorize one of the scriptures you discussed in class (it might help to break the scripture into short phrases) and share the verse with their families.

Improving Our Teaching

Modify activities for the age of the children you teach. Younger children need detailed explanations and learn from a variety of teaching methods. As children mature they can contribute more and may be better at sharing their thoughts. Give them opportunities to share, testify, and participate, and provide help as needed. (See *Teaching in the Savior’s Way*, 25–26.)

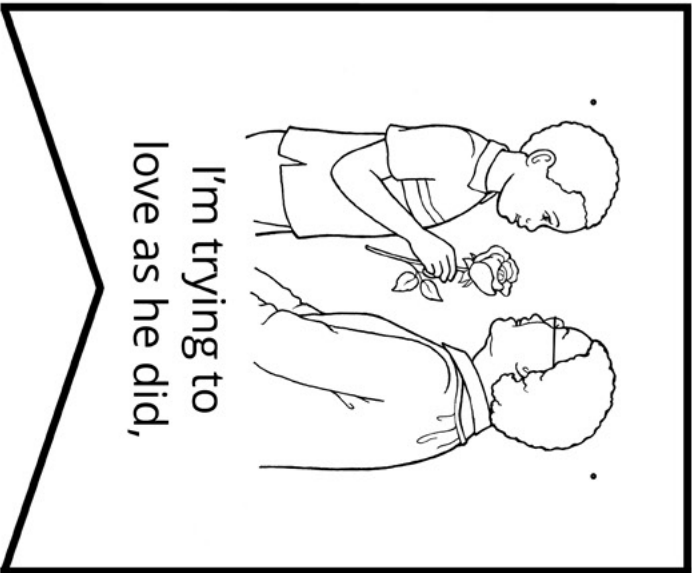

I'm trying to
love as he did,

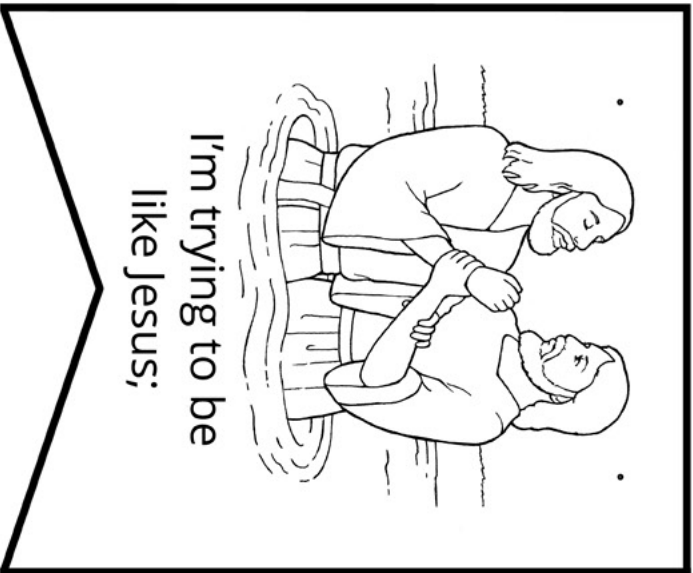

I'm trying to be
like Jesus;

**Jesus Christ wants
us to follow Him
(Luke 18:22).**

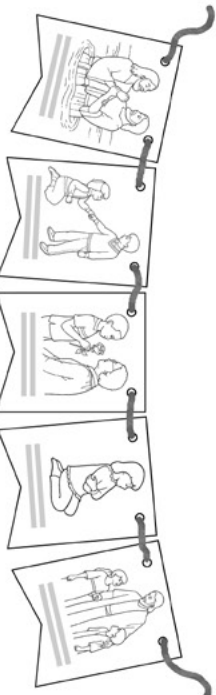

(See "I'm Trying to Be like Jesus," *Children's Songbook*, 78-79.)

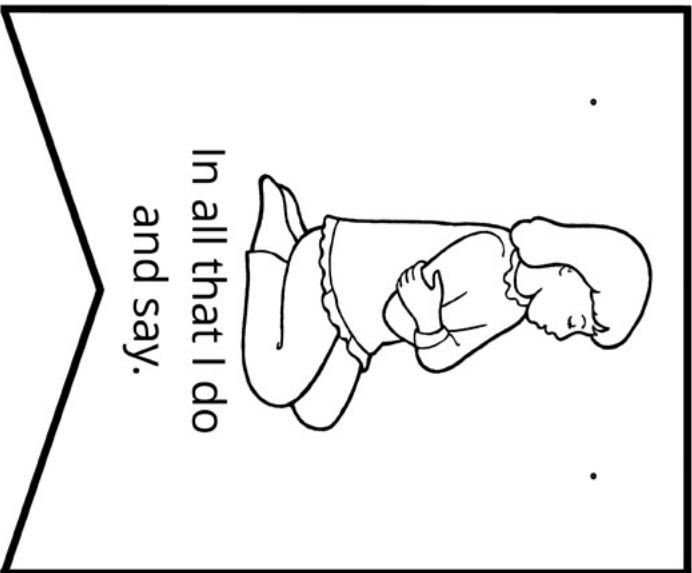

In all that I do
and say.

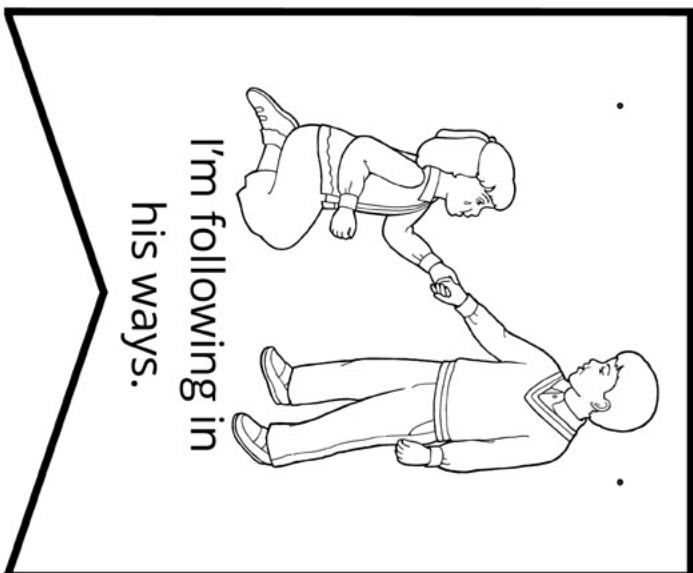

I'm following in
his ways.

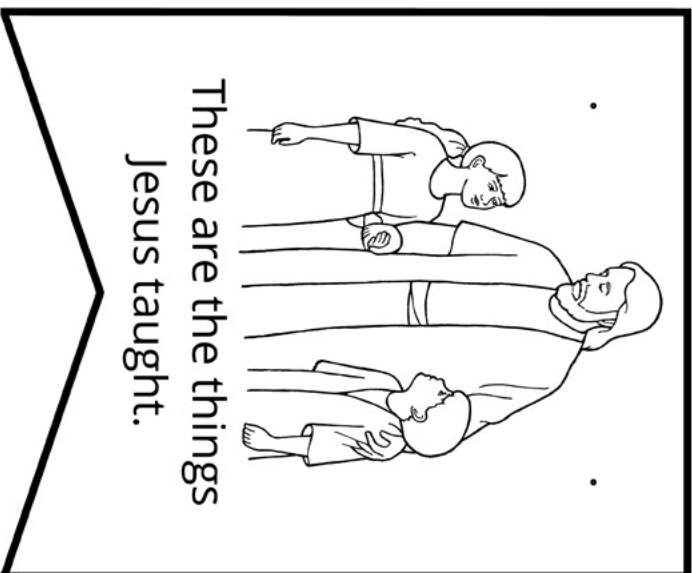

These are the things
Jesus taught.



JANUARY 7-13

Matthew 1; Luke 1

“Be It unto Me according to Thy Word”

Start by reading *Matthew 1* and *Luke 1*. *Come, Follow Me—For Individuals and Families* can help you understand these chapters, and this outline can give you teaching ideas. If you need additional help teaching younger children, see “Meeting the Needs of Younger Children” at the beginning of this resource.

RECORD YOUR IMPRESSIONS _____



Invite Sharing

Ask the children to sit in a circle, and then ask one child to share something he or she has learned from the scriptures this week or at another time. That child could roll a ball to or point to another child in the circle, who then takes a turn to share.



Teach the Doctrine Younger Children

MATTHEW 1:18-25; LUKE 1:26-38

Angels announced the birth of Jesus.

Mary and Joseph were each visited by an angel who announced the birth of Jesus Christ. These experiences can help the children see how important Christ’s birth was.

Possible Activities

- Invite a child’s parents to come to class dressed up as Mary and Joseph. Ask them to share their experiences as recorded in *Matthew 1:18-25* and *Luke 1:26-38*.
- Tell the story of angels appearing to Mary and Joseph, as recorded in these verses. (See also “Chapter 2: Mary and the Angel” and “Chapter 4: Joseph and the Angel,” *New Testament Stories*, 8-9, 12, or the corresponding videos on LDS.org.) You could show the picture in this week’s outline in *Come, Follow Me—For Individuals and Families*. Invite the children to repeat the story back to you.
- Invite the children to draw pictures of the stories found in *Matthew 1:18-25* and *Luke 1:26-38*.

LUKE 1:5-20, 57-63

Heavenly Father answers my prayers.

Zacharias and Elisabeth had probably been praying for a child for many years. Eventually Heavenly Father

answered their prayers by sending them a son, John the Baptist. How can you use this story to teach the children that Heavenly Father answers prayers?

Possible Activities

- In your own words, share the story from Luke 1:5–20, 57–63. You may want to repeat the story a few times. Assign children to play the parts of the angel, Zacharias, and Elisabeth and act out the story. Emphasize that Heavenly Father answered the prayers of Elisabeth and Zacharias, and share an experience in which Heavenly Father answered your prayer.
- Use “We Bow Our Heads,” *Children’s Songbook*, 25, or another song to teach the children how to pray. You could also sing together “A Child’s Prayer,” *Children’s Songbook*, 12–13. Every time the children sing the words “pray” or “prayer,” invite them to bow their heads and fold their arms.
- Ask each child to do actions that represent something he or she can pray for. Let the other children guess what the actions represent. They can find ideas on this week’s activity page.

LUKE 1:31–35

Jesus Christ is the Son of God.

Jesus Christ is the Son of Heavenly Father and Mary. What can you do to help the children learn more about Him?

Possible Activities

- Tell the children that the angel told Mary that her baby would be called the Son of God (see Luke 1:35). Help the children repeat the phrase “Jesus Christ is the Son of God.” Help the children understand who Jesus’s parents were by inviting them to draw pictures of their own parents. As they do this, tell them that Jesus had parents too—Mary and Heavenly Father. In addition, Joseph was asked to protect and take care of Jesus while He lived on earth.

- Share your testimony that because Jesus was the Son of God, He could die for our sins and come back to life. Show pictures of Jesus’s Crucifixion and Resurrection (see *Gospel Art Book*, nos. 57, 59).



Teach the Doctrine

Older Children

MATTHEW 1:18–25; LUKE 1:5–37

With God nothing is impossible.

The births of Jesus and John the Baptist were only possible through the power of God. Learning about these miracles can strengthen the children’s faith that God has the power to work miracles in their lives.

Possible Activities

- As you and the children review Matthew 1:18–25 and Luke 1:5–37, ask the children questions like “What would you say if you were Mary?” or “How would you feel if you were Zacharias?”
- In simple terms, tell the stories of the births of John the Baptist and Jesus Christ. Ask the children to raise their hands when they hear something that might seem impossible without God’s power. What other stories can the children share in which God did something that seemed impossible?
- Help the children memorize Luke 1:37. To do this, you could write the verse on the board and invite the children to recite it several times. After each time, erase one word.

MATTHEW 1:21–25; LUKE 1:30–35, 46–47

Jesus Christ is the Son of God.

Jesus Christ is the Son of Heavenly Father and Mary. How can you help the children learn this truth?

Possible Activities

- Ask the children to read Luke 1:30–35, looking for answers to these questions: “Who is Jesus’s

mother?” and “Who is Jesus’s Father?” Help them understand that Jesus Christ is the only person whose physical father was Heavenly Father (see also 1 Nephi 11:18–21).

- As you read these verses, invite the children to search for names or titles of Jesus Christ. What do these names mean, and what do they teach us about Jesus?
- Share your testimony of Jesus Christ, and invite the children to share theirs.



The Annunciation, by John Scott

LUKE 1:5–25, 57–80

Heavenly Father hears and answers my prayers.

God answers prayers but not always in ways we might expect. How can you use the account of Zacharias and Elisabeth to teach the children this truth?

Possible Activities

- Ask the children what they would say to someone who had prayed for a blessing but had not received it yet. Invite them to think about this question as they read together Luke 1:5–25, 57–80. (See also “Chapter 1: Elisabeth and Zacharias” and “Chapter 3: John the Baptist Is Born,” *New Testament Stories*, 6–7, 10–11, or the corresponding videos on LDS.org.) What might Zacharias and Elisabeth tell someone who felt their prayer wasn’t being answered?
- Invite several children ahead of time to share experiences when Heavenly Father answered their prayers. Share a time in which you felt your prayers were answered in an unexpected way.
- Invite the children to draw a picture of a time when Heavenly Father answered a prayer—especially one of their own. Let them share their drawings with the class.



Encourage Learning at Home

Invite the children to share with their families the pictures they drew and then ask their family members to share times when God answered their prayers.

Improving Our Teaching

Help young children learn from the scriptures. To help young children learn from the scriptures, focus on a single verse of scripture or even just a key phrase. You might invite the children to stand up or raise their hands when they hear that word or phrase. (See *Teaching in the Savior’s Way*, 21.)

Heavenly Father answers my prayers (Luke 1:5-20, 57-63).

Color and cut out the pictures. Then sort them into two groups:
things we are thankful for and people we can pray for.

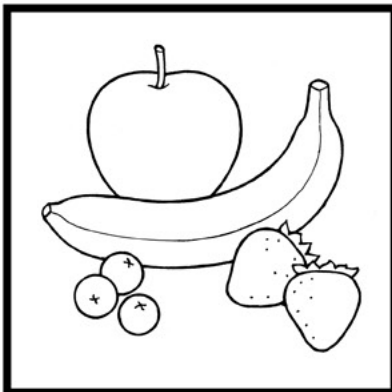
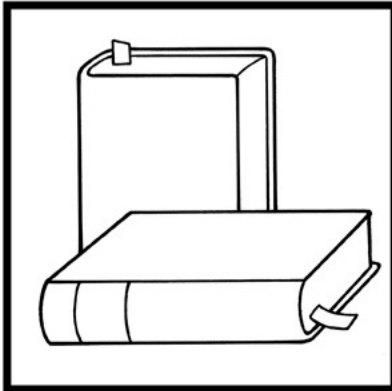
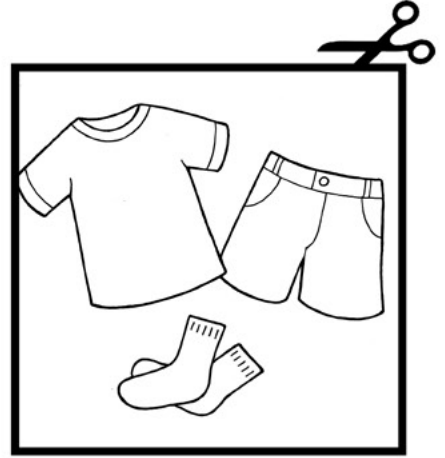



Let Us Adore Him, by Dana Mario Wood

JANUARY 14–20

Luke 2; Matthew 2

We Have Come to Worship Him

Start by reading **Matthew 2** and **Luke 2**. This week’s outline from *Come, Follow Me—For Individuals and Families* can help you understand these chapters, and this outline can give you teaching ideas.

RECORD YOUR IMPRESSIONS _____



Invite Sharing

Ask the children to tell you what they remember about Christ’s birth. What are their favorite parts of the story?



Teach the Doctrine Younger Children

LUKE 2:1–14

Jesus was born.

Jesus left His home with Heavenly Father to be born on earth so He could be our Savior. How can you help the children remember the story of Christ’s birth?

Possible Activities

- As you read the story of Christ’s birth, invite the children to act out the story themselves or use this week’s activity page. See also “Chapter 5: Jesus

Christ Is Born,” *New Testament Stories*, 13–15, or the corresponding video (LDS.org).

- If you have one, bring a Nativity set and invite the children to set the pieces in appropriate places as you tell them the story of Jesus Christ’s birth. You could also show a picture of the Nativity (see, for example, this week’s outline in *Come, Follow Me—For Individuals and Families*). Point to different people in the Nativity and invite the children to share what they know about each person.
- Sing together the children’s favorite songs about Jesus’s birth. As you do, look for opportunities to bear your testimony of the Savior and invite the children to share why they love Jesus.

MATTHEW 2:1–12

I can give good gifts to Jesus.

The Wise Men gave Jesus gifts of gold, frankincense, and myrrh. How can you use this story to teach the children that they can give gifts to Jesus too—like love, service, and obedience?

Possible Activities

- Show a picture of the Wise Men as you review their story, found in Matthew 2:1–12, with the children. You could show the picture Wise Men Present Gifts (LDS.org).
- Gift wrap pictures or objects that represent gifts we can give to Jesus. Invite the children to help you open the gifts and discuss how we give these gifts to the Savior.
- Help each child draw or write a list of gifts they can give Jesus, such as “being a good friend” or “praying.” Invite the children to share their lists with the class and choose one to work on this week.

LUKE 2:40–52

Jesus was once a child like me.

Learning about the Savior’s childhood may help the children you teach relate to Him. Ask the children what they can learn from these verses about how they can be like Jesus now.

Possible Activities

- Invite one of the youth in the ward to visit the class and share the story of Jesus teaching in the temple when He was a young man.
- Ask several children ahead of time to bring pictures of themselves as babies to share. Ask them how they have grown. Share some of the ways Jesus grew (see Luke 2:40, 52). Sing with the children “Jesus Once Was a Little Child,” *Children’s Songbook*, 55, or another song about the Savior.
- Read Luke 2:52 and explain what “wisdom” and “stature” mean. You might ask the children to perform actions that show what it means to increase in wisdom and in favor with God and other people. For example, they could act out reading a book or helping someone in need.



Teach the Doctrine

Older Children

LUKE 2:1–21; MATTHEW 2:1–2

Ancient prophets foretold of the Savior’s birth.

Prophets and believers had been looking forward to the Savior’s birth for centuries. Understanding this truth can help the children gain a deeper appreciation for the Savior’s life and mission.

Possible Activities

- Ask the children to talk about things they look forward to, such as a birthday or holiday. Have the children read Helaman 14:2–5 to find something prophets were looking forward to.
- Read together some prophecies of the Savior’s birth (see Isaiah 7:14; 9:6; 1 Nephi 11:18; Helaman 14:5). Help the children list details these prophecies contain and find their fulfillment in Luke 2:1–21 and Matthew 2:1–2.
- Invite the children to draw a picture of the Nativity and share why they are grateful Jesus was born.



Simeon Reverencing the Christ Child, by Greg K. Olsen

LUKE 2:40, 52**Jesus was once a child like me.**

Like Jesus, the children you teach have an important mission to prepare for. What can they learn from Jesus's example?

Possible Activities

- As you read Luke 2:40, 52, tell the children to listen for the things Jesus did. Invite the children to share ways in which they have grown since they were little. Share your own experience of learning the gospel little by little; then bear your testimony.
- Complete activities that illustrate phrases in Luke 2:40, 52. For example, you could measure each child's height ("Jesus increased in . . . stature") or have them share their favorite scripture ("waxed strong in spirit"). Help the children make a record of ways they are growing and share it with their families.
- After reviewing Luke 2:40, 52, invite the children to share what they think Jesus would have been like when He was their age. How would He have treated His mother? His brothers and sisters?

LUKE 2:41-52**I can follow Jesus's example.**

Even as a young man, Jesus was teaching the elders in the temple. Similarly, the children in your class have much to teach those around them.

Possible Activities

- Invite a child to come prepared to summarize the story in Luke 2:41–52. To help the children understand the story, teach what the "Father's business" means. For example, you could tell the children what you or your parents do for a job. What was the job or "business" of Joseph, Jesus's earthly father? (see Matthew 13:55). What was the business of His Heavenly Father? (see Luke 2:46–49; see also Moses 1:39).
- With the children, read Luke 2:46–49 and ask, "How was Jesus doing His 'Father's business?'" Help the children list or draw on the board ways they can help do Heavenly Father's business too.
- To help the children build their confidence that they, like the boy Jesus, can teach the gospel, help them practice teaching each other a principle from *For the Strength of Youth*.



Encourage Learning at Home

Invite the children to teach their family something they learned about the birth of Christ.

Improving Our Teaching

Children are curious and learn in many ways. Children enjoy learning through new and varied experiences. Use activities that help them move about, use all their senses, explore, and try new things. (See *Teaching in the Savior's Way*, 25–26.)

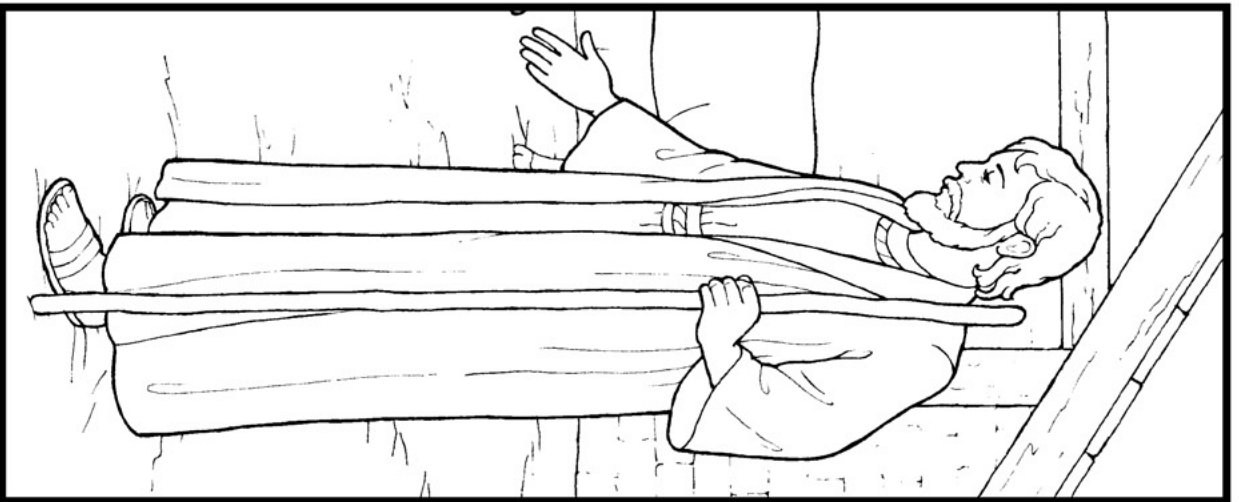
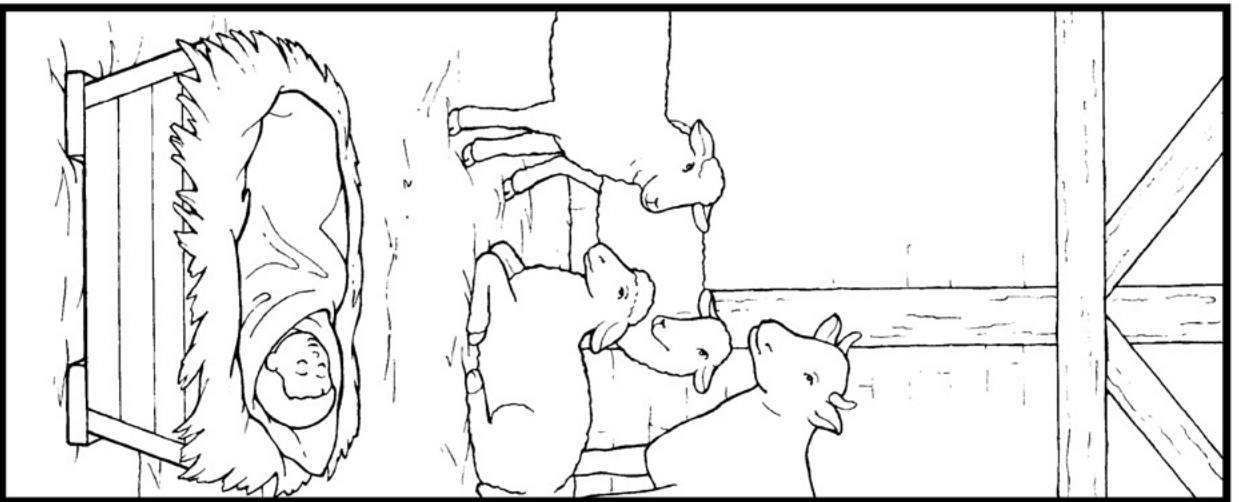

We have come to worship Him (Luke 2; Matthew 2).

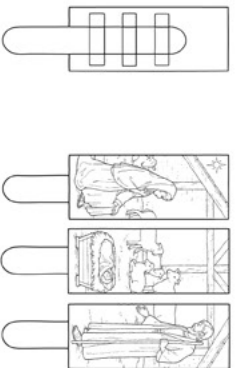



JANUARY 21-27

John 1

We Have Found the Messiah

As you read John 1, record spiritual impressions you receive. This week’s outline in *Come, Follow Me—For Individuals and Families* can help you understand this chapter. The following suggested activities can give you ideas about how to help the children learn the principles in John 1. The activities for older children can be adapted, if needed, for younger children.

RECORD YOUR IMPRESSIONS _____



Invite Sharing

To help the children share what they know about Jesus, you could show pictures of Him fulfilling some of His roles described in John 1. Then ask them to describe what is taking place (such as creating the earth or teaching the gospel).

World,” *Ensign* or *Liahona*, Nov. 2010, 129). How will you teach the children this truth?



Teach the Doctrine Younger Children

JOHN 1:1-2

Jesus lived with Heavenly Father before He was born.

John taught that Jesus Christ lived with God before His mortal experience. We too lived with God before we were born (see “The Family: A Proclamation to the

Possible Activities

- Explain that “the Word” in John 1:1 refers to Jesus. Read the verse aloud, and ask the children to say “Jesus” each time you read “the Word.” Show the line drawing Premortal Life (LDS.org). Explain that Jesus Christ lived with Heavenly Father before He came to earth.
- Teach the children that we also lived with God before we came to earth. You may want to use “Introduction: Our Heavenly Father’s Plan,” *New Testament Stories*, 1–5; the corresponding video (LDS.org); or Guide to the Scriptures, “Premortal Life,” scriptures.lds.org.
- Invite a parent to bring a baby to class, and use this as an opportunity to teach that we lived in heaven with Heavenly Father as spirit children before we were born.

JOHN 1:3

Jesus created all things.

Many children naturally enjoy being among the Lord’s creations. Knowing about Christ’s role as Creator can help increase their reverence for Him.

Possible Activities

- Read John 1:3 with the children, and show the picture from this week’s outline in *Come, Follow Me—For Individuals and Families*. Help the children memorize the phrase “all things were made by [Jesus Christ].”
- Take the children for a walk outside. Let the children take turns describing a creation they see, and ask the class to guess what they are describing.
- Ask the children to think of ways in which they can take care of the creations around them (for example, being kind to animals).



Jesus Christ created the world and all things in it.

JOHN 1:35–51

I can invite others to come to Jesus Christ and learn of Him.

John 1 contains accounts of disciples who invited people to “come and see” that Jesus is the Son of God. Even small children can follow this example.

Possible Activities

- Describe how John taught Andrew about Jesus, and tell how Andrew in turn taught Peter (see John

1:35–42). Share how you learned about the Church, or invite a new member to share how he or she learned about the Church.

- Share the story of Philip inviting Nathanael to “come and see” (John 1:43–51). Hide a picture of Jesus in a box, and invite one child to “come and see” it and then tell the other children about what he or she saw.
- Let the children color this week’s activity page, and encourage them to use it to invite someone to learn about Jesus.
- Ask a child to tell about a time when he or she shared something, such as a toy or gift, with someone. How can we share the gospel? Tell a story of a child who shared the gospel with a friend, such as Elder M. Russell Ballard’s story about Joshua (“Following Up,” *Ensign* or *Liahona*, May 2014, 78–81).



Teach the Doctrine
Older Children

JOHN 1:1–5

Jesus Christ lived with Heavenly Father before He was born.

Even before He was born, Jesus Christ played important roles in Heavenly Father’s plan. As you read John 1:1–5, what impresses you about Christ’s premortal work?

Possible Activities

- Ask the children if they know anything about what Jesus did before He was born. Invite them to look for answers in John 1:1–5. It might help to look in Joseph Smith Translation, John 1:1–5 (in the Bible appendix).
- Share “Introduction: Our Heavenly Father’s Plan,” *New Testament Stories*, 1–5, with the children or

show the corresponding video (LDS.org). Ask the children what they learn about Jesus Christ.

- Invite some children to come to class prepared to display or describe something they created. Show pictures of some of the Lord's creations, and use John 1:3 to explain that Jesus created all things.

JOHN 1:4-9

Jesus Christ is my light.

The symbolism of light can help children understand the Savior and His gospel. How can you inspire the children to seek the light of the Savior when the world seems dark?

Possible Activities

- Invite the children to read Psalm 27:1; John 1:4-9; Mosiah 16:9; and Doctrine and Covenants 39:1-2, looking for phrases that these scriptures have in common. How is Jesus Christ like a light?
- Show a picture of the Savior and some objects that give light, such as a flashlight. How is Jesus Christ like these objects? How can we share His light with others? Sing together "The Lord Is My Light" (*Hymns*, no. 89) or another song about gospel light.
- Ask the children what they do when they are in darkness and feel afraid. Testify that they can always turn to the Savior when they are fearful.

JOHN 1:35-51

As a follower of Jesus Christ, I invite others to follow Him.

Consider how you can use the examples in John 1:35-51 to encourage the children to invite others to learn about the Savior.

Possible Activities

- Help the children search John 1:35-51 to find things that people said to invite others to learn about the Savior. Let them practice what they might say to invite a friend to learn about Him.
- Ask the children to use this week's activity page to make an invitation they could use to invite a friend or family member to learn more about Jesus Christ.
- Give the children the opportunity to tell the class about something that they love. Help the children see how sharing the gospel can be like sharing other things we love. You may want to show the video "Good Things to Share" (LDS.org).



Encourage Learning at Home

Encourage the children to invite someone they love to learn more about Jesus Christ.

Improving Our Teaching

Help the children visualize the story. Find ways to create an image of the story, including gospel art, drawings, videos, puppets, or skits.

Fold B

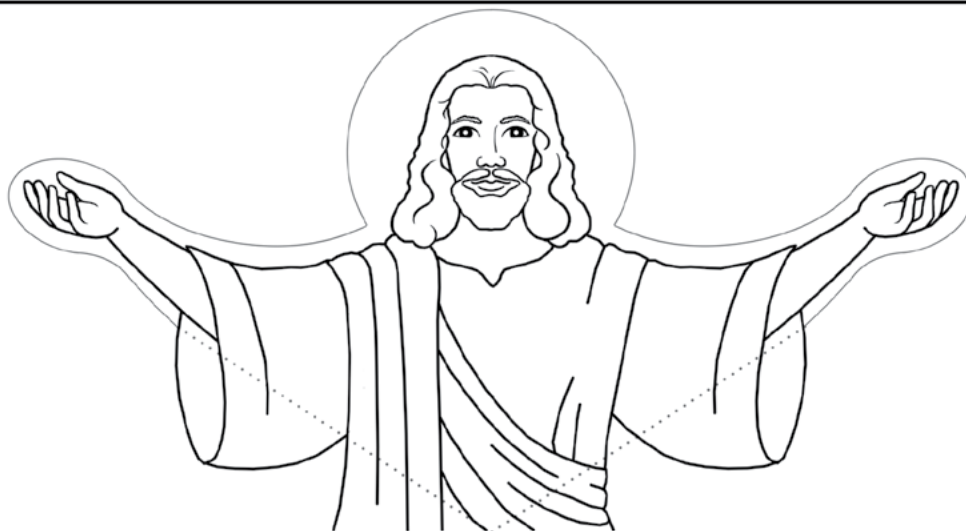

Learn of Jesus Christ

Fold A →

← Fold A

Handwritten cursive flourish

From:

To:

Handwritten cursive flourish

Handwritten cursive flourish

I invite you to:

Handwritten cursive flourish

We have found the Messiah (John 1).

Make a "pop-up" invitation to invite a friend to learn of Jesus Christ by coming to church, to family home evening, or to a baptism.

Fold B

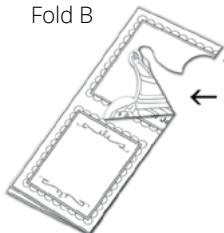

← Cut solid line

← Fold dotted line





Stained-glass window in Nauvoo Illinois Temple, by Tom Holdman

JANUARY 28–FEBRUARY 3

Matthew 3; Mark 1; Luke 3

“Prepare Ye the Way of the Lord”

As you read about John the Baptist and the baptism of Jesus Christ, record any spiritual impressions you receive. *Come, Follow Me—For Individuals and Families* can help you understand these scriptures, and it will help you support the learning that your class members are doing on their own.

RECORD YOUR IMPRESSIONS _____



Invite Sharing

To give children a chance to share what they have already learned, show a picture of Jesus being baptized, and ask them to tell you what is happening in the picture and how they feel about being baptized.



Teach the Doctrine

Younger Children

MATTHEW 3:13–17

I can be baptized as Jesus was.

How can you use the account of Jesus’s baptism to help the children prepare to be baptized?

Possible Activities

- Summarize the story of the Savior’s baptism (see Matthew 3:13–17; see also “Chapter 10: Jesus Is

Baptized,” *New Testament Stories*, 26–29, or the corresponding video on LDS.org). Repeat the story several times and invite the children to share the details they remember. Explain that Jesus was baptized by immersion by someone who had priesthood authority.

- Show a picture of Jesus being baptized and this week’s activity page. Let the children point out similarities between the two pictures.
- You might review the promises the children will make when they are baptized (see Mosiah 18:8–10; D&C 20:37; *True to the Faith*, 23). Ask them which of these things they are already doing.
- Invite a member of the bishopric to tell the children about the baptismal interview they will have before they are baptized.
- Sing “Baptism,” *Children’s Songbook*, 100–101, with the children. Consider asking a child who knows the song well to lead the other children while they sing.



We can follow Jesus's example by being baptized.

MATTHEW 3:11, 16

The Holy Ghost helps me.

In addition to preparing for baptism, the children are also preparing to receive the gift of the Holy Ghost. How can you help them?

Possible Activities

- Use Matthew 3:11, 16 to teach the children that the Holy Ghost descended on Jesus when He was baptized (a dove appeared as a sign to show that this had happened). Show the picture *The Gift of the Holy Ghost* (*Gospel Art Book*, no. 105), and explain that we receive the gift of the Holy Ghost when we are confirmed.
- Bring a box containing things such as a picture of Jesus, a comforting blanket, and a compass. Invite the children to select an item and then share how each object represents a way the Holy Ghost can help us—He testifies of Jesus, comforts us (see John 15:26), and shows us the right way (see 2 Nephi 32:5).
- Share your own experiences with receiving help from the Holy Ghost.
- Invite the children to listen for ways the Holy Ghost helps us as they sing “The Holy Ghost” (*Children’s Songbook*, 105).



Teach the Doctrine
Older Children

MATTHEW 3

I am blessed by the ordinances of the Aaronic Priesthood.

John the Baptist held the Aaronic Priesthood, so this is a good opportunity to teach the children about the Aaronic Priesthood and help them recognize the blessings and power that come to both men and women through this priesthood.

Possible Activities

- Invite the children to make a list of Aaronic Priesthood duties, using Doctrine and Covenants 20:46, 58–60; 84:111. Explain that priests in the Aaronic Priesthood can “baptize, and administer the sacrament.” Priests, teachers, and deacons are to “teach, and invite all to come unto Christ” (D&C 20:46, 59). Ask the children to look in Matthew 3 for examples of John fulfilling these duties. How can all of us invite others to come unto Christ, as John did?
- Display some pictures of Aaronic Priesthood holders performing the ordinances of baptism and the sacrament (see *Gospel Art Book*, nos. 103, 108). Discuss how these ordinances prepare us to receive Jesus Christ and His Atonement.
- Read together Doctrine and Covenants 13:1, and explain that John the Baptist restored the Aaronic Priesthood to Joseph Smith. Ask the children how they have been blessed because the Aaronic Priesthood was restored.

MATTHEW 3:13–17; LUKE 3:2–18

I can keep my baptismal covenants.

The account of Jesus’s baptism is a good opportunity to help the children review their baptismal covenants and recommit to keeping them.

Possible Activities

- Ask two children to read Luke 3:7–9, 15–17, one reading the words of John the Baptist and the other reading the rest of the words. After each verse, pause and help the children understand what the verse means.
- Review the covenants the children made at baptism, found in Mosiah 18:8–10 and Doctrine and Covenants 20:37. (See also *True to the Faith*, 23–26.) Invite the children to write these references on this week's activity page.
- Prepare several pairs of cards with matching phrases or pictures that represent our baptismal covenants. Place the cards facedown. Invite the children to take turns turning over two at a time, looking for a match. After a match is made, invite children to share ways they have kept that covenant.
- Share how keeping your baptismal covenants has blessed you.

MATTHEW 3:11, 16

The Holy Ghost can guide me.

Children are learning how to recognize and follow the Holy Ghost's guidance. How can you teach them that

keeping their baptismal covenants will help them be worthy to receive this guidance?

Possible Activities

- Ask each child to choose one of the following scriptures to read and explain how the Holy Ghost speaks to us: Doctrine and Covenants 6:23; 8:2–3.
- Ask a child to read Matthew 3:11. How is the Holy Ghost like fire? For instance, fire is comforting, and it gives light to guide us (see John 15:26; 2 Nephi 32:5).
- Invite the children to close their eyes and hold out their hands. Then lightly brush their palms with a feather or string. Invite them to tell you when they feel it. What does this activity teach about recognizing the impressions of the Holy Ghost?
- Invite the children to share experiences they have had with the Holy Ghost. Why does keeping our covenants help us to have the guidance of the Holy Ghost?



Encourage Learning at Home

Encourage the children to ask their parents or other family members about their baptism.

Improving Our Teaching

Seek your own inspiration. Don't view these outlines as instructions that you must follow as you teach. Rather, use them as ideas to spark your own inspiration as you ponder the needs of the children you teach. (See *Teaching in the Savior's Way*, 7.)

I can be baptized as Jesus was.



(Matthew 3:13-17)



Christ Triumphant over Satan,
by Robert T. Barrett

FEBRUARY 4-10

Matthew 4; Luke 4-5

“The Spirit of the Lord Is upon Me”

Start your preparation for this lesson by reading **Matthew 4** and **Luke 4-5**. *Come, Follow Me—For Individuals and Families* can help you understand these chapters, and this outline can give you teaching ideas.

RECORD YOUR IMPRESSIONS _____



Invite Sharing

Ask the children to pass a picture of Jesus from one child to the next. As each child receives the picture, invite him or her to share something that Jesus did when He was on earth.

- Display a picture of Jesus Christ, and then describe choices a young child might make. For each good choice, ask the children to take a step toward the picture. For each bad choice, ask them to take a step away from it.
- Help the children learn the words to “Choose the Right Way,” *Children’s Songbook*, 160-61, using pictures, objects, or other visual aids that correspond to the lyrics.



Teach the Doctrine

Younger Children

MATTHEW 4:1-11; LUKE 4:1-13

I can choose the right as Jesus did.

Little children “cannot sin” (D&C 29:47). However, the account of Jesus resisting Satan’s temptations can inspire the children to start now to choose the right.

Possible Activities

- Tell the story of Jesus’s temptations from Matthew 4:1-11. (See also “Chapter 11: Jesus Is Tempted,” *New Testament Stories*, 30-31, or the corresponding video on LDS.org.) At appropriate points in the story, ask, “What do you think Jesus should do?”

LUKE 4:18-19

Jesus Christ is my Savior.

Luke 4:18-19 lists aspects of Jesus’s mission. How can you help the children appreciate what He has done for them?

Possible Activities

- Read Luke 4:18-19 to the children, and explain what Jesus Christ was sent to earth to do (teach, comfort, and heal people). Share how He has done this for you.
- Invite a few children to pretend to be confused, sad, or sick. Ask the other children to role-play what

they could do to help them. Testify that Jesus Christ came to teach, comfort, and heal us, and that we should follow His example.

- Show pictures of Jesus fulfilling aspects of His mission (see *Gospel Art Book*), and ask the children to describe what Jesus is doing. Also show pictures of people trying to be like Jesus (you might find some in Church magazines).
- Write on strips of paper phrases that begin with “Because of Jesus Christ” (such as “Because of Jesus Christ, my family can be together forever”). Invite each child to pick one of the paper strips, and help him or her read the phrase.

MATTHEW 4:18–22; LUKE 5:1–11

Jesus Christ invites us to be “fishers of men.”

The Savior’s call, “Follow me, and I will make you fishers of men” (Matthew 4:19), applies to everyone, including children.

Possible Activities

- Invite two children to pretend to be Simon Peter and Andrew as you read Matthew 4:18–22. Help the children identify what these men gave up to follow Jesus.
- Let the children take turns telling the story from these verses using the picture in this week’s outline in *Come, Follow Me—For Individuals and Families*.
- Sing together “I Will Follow God’s Plan,” *Children’s Songbook*, 164. What can we learn from this song about following Jesus Christ?
- Use this week’s activity page to discuss with the children how they can be “fishers of men” by following Jesus. You could also play a matching game: cut out two copies of each fish, place them facedown, and invite the children to turn them over one at a time to make a match.



Christ Calling Two Disciples, by Gary Ernest Smith



Teach the Doctrine

Older Children

MATTHEW 4:1–11; LUKE 4:1–13

Jesus set the example for me by resisting temptation.

Even Jesus Christ was tempted by Satan, but He never gave in. How can you help the children follow His example?

Possible Activities

- Make a chart on the board labeled *Satan’s Temptations* and *Jesus’s Responses*. Help the children fill in the chart using Matthew 4:1–11 and Luke 4:1–13. Ask the children how they can follow Jesus’s example.
- Write down some scenarios in which a child might be tempted to make a wrong choice. Let a child select one to read, and discuss as a class how they could resist temptation in that situation.

MATTHEW 4:1–2

Fasting can help me feel close to Heavenly Father.

Before beginning His ministry, Jesus fasted and “communed with God” (Joseph Smith Translation, Matthew 4:2 [in Matthew 4:2, footnote c]). Help the

children see how fasting can give them spiritual strength and help them feel close to Heavenly Father.

Possible Activities

- Invite a child to read aloud Matthew 4:1-2 using the Joseph Smith Translation revisions found in the footnotes. What did Jesus do to “be with God”? Share how fasting has helped you feel closer to Heavenly Father.
- Invite children who have fasted before to share their experiences. How would they explain fasting to someone who has never fasted before?
- Write questions about fasting (such as why, when, or how we fast) on pieces of paper, and place them in a bowl. Invite children to pick a question and try to answer it. What experiences can you or the children share about fasting?

LUKE 4:16-22, 28-30

Jesus Christ is my Savior.

Ponder how the Savior has blessed your life. How can you help the children better appreciate His influence in their lives?

Possible Activities

- Invite a child to come to class prepared to summarize Luke 4:16-30. It might be helpful to use “Chapter 17: Angry People in Nazareth,” *New Testament Stories*, 42-43; the corresponding video (LDS.org); or the video “Jesus Declares He Is the Messiah” (LDS.org).

- Read Luke 4:18 aloud while the children follow along. Ask them to create a list of things the Savior said He came to do. Invite the children to share examples of times when Christ did these things, either in the scriptures or in their lives.

MATTHEW 4:18-22; LUKE 5:1-11

Jesus Christ invites us to follow Him and to be “fishers of men.”

There are many ways children can follow the Savior and be “fishers of men” (Matthew 4:19). How will you help them see the good influence they can be on others?

Possible Activities

- Invite the children to read Matthew 4:18-22 and Luke 5:1-11. How did Jesus’s disciples respond to His call to follow Him? What can we do to follow their example?
- Show the children some fishing equipment or a picture of a fisherman. What does it mean to be “fishers of men”? What tools do we have to help us be fishers of men?



Encourage Learning at Home

Invite the children to share with their families what they learned about being fishers of men.

Improving Our Teaching

Children can recognize the Spirit’s influence. Teach the children that the feelings of peace, love, and warmth they have when they talk or sing about Jesus Christ and His gospel come from the Holy Ghost. These feelings can build their testimonies.

**Jesus invites us to be fishers of men
(Matthew 4:18-22; Luke 5:1-11).**

On the blank fish, draw or write a way you will be a fisher of men.

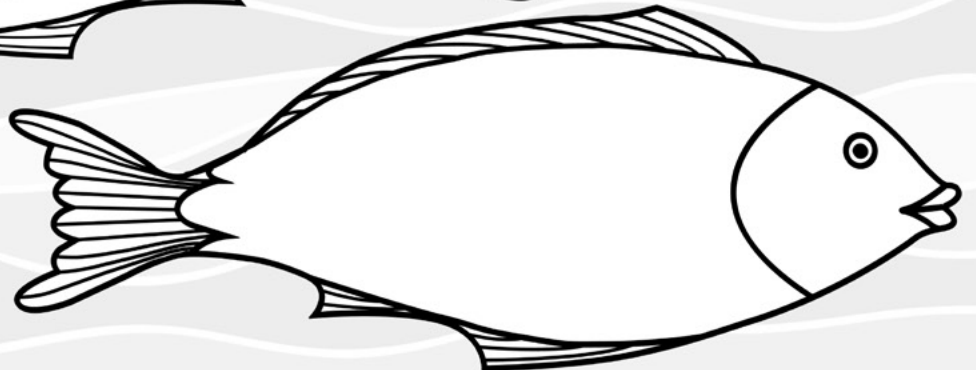
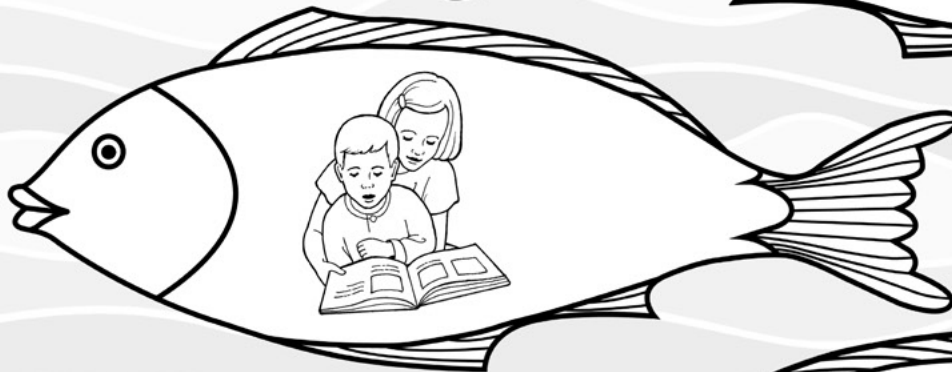
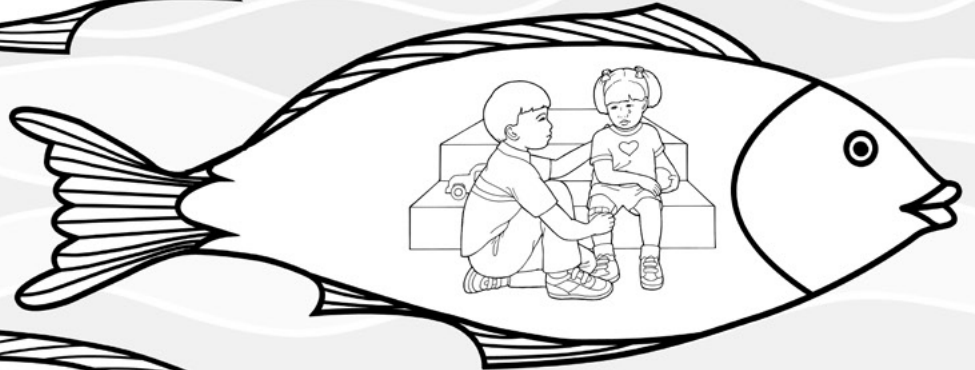
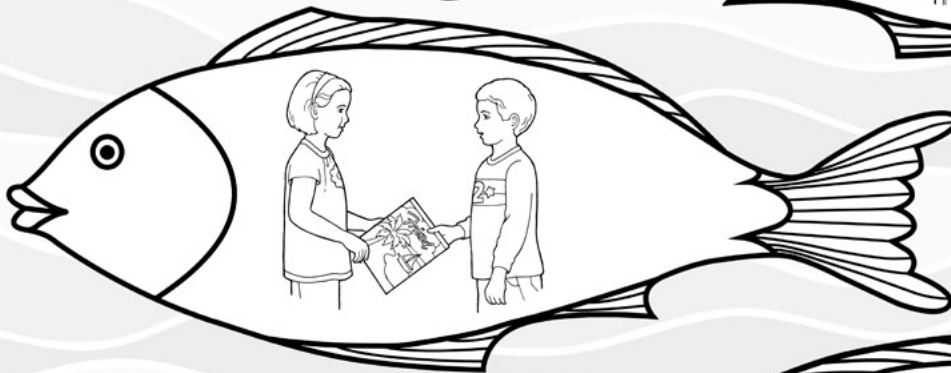
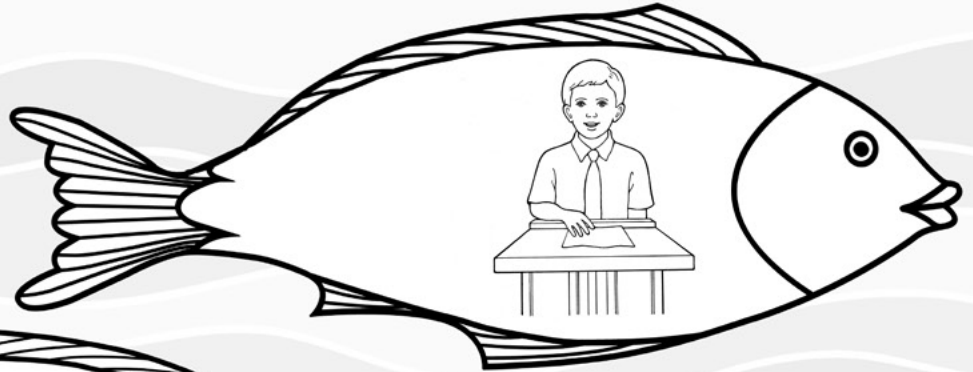
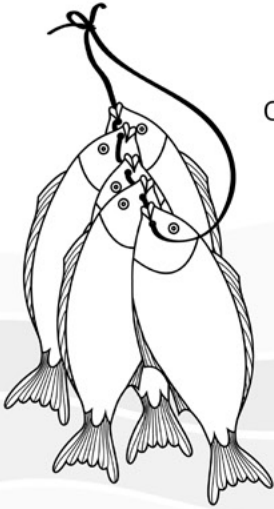



FEBRUARY 11-17

John 2-4

“Ye Must Be Born Again”

Your preparation to teach begins as you read John 2-4. *Come, Follow Me—For Individuals and Families* can help you understand these chapters, and this outline can give you teaching ideas.

RECORD YOUR IMPRESSIONS _____



Invite Sharing

Encourage the children to share what they are learning and experiencing by asking them what they did recently to be “fishers of men” (Matthew 4:19). You may need to review last week’s lesson with them.



Teach the Doctrine

Younger Children

JOHN 3:1-10

I need to be baptized and confirmed to return to live with Heavenly Father.

The children you teach are preparing to take important steps to live with Heavenly Father again by being baptized (born of water) and confirmed (born of the Spirit). How can you help them understand the importance of these two ordinances?

Possible Activities

- Summarize the story of Jesus teaching Nicodemus. Promise the children that when they are baptized, Heavenly Father will give them the gift of the Holy Ghost.
- Use John 3:5 and this week’s activity page to teach that we need to be baptized and confirmed to live with Heavenly Father again.
- Ask the children to talk about what they do to wash their hands. Show the picture *Girl Being Baptized* (*Gospel Art Book*, no. 104), and help the children compare washing our hands with water to becoming spiritually clean through baptism.

JOHN 3:16

Heavenly Father loves me, so He gave me a Savior.

How can you help children learn this precious truth?

Possible Activities

- Ask the children to complete sentences like this one: “Because my parents love me, they. . . .” Read John 3:16. Then help each child repeat John 3:16, replacing the words “the world” with his or her own name, and have the children listen for what Heavenly Father did because He loves us. Invite the children to draw pictures of things that help them feel Heavenly Father’s love for them (such as family, nature, the scriptures, and so on). Let them share their drawings with each other.
- Let the children hold up a picture of Jesus every time they sing “Son” in “He Sent His Son,” *Children’s Songbook*, 34–35.

JOHN 4:5–15

Jesus Christ is my “living water.”

Children in your class can all relate to feeling thirsty. How can you use that experience to help children understand how much we need the living water Jesus Christ offers?

Possible Activities

- Use the picture in this week’s outline in *Come, Follow Me—For Individuals and Families* to tell the story of Jesus and the woman at the well. Ask the children to retell the story.
- Show a glass of water, and ask the children what would happen if we were very thirsty and the glass was empty. Briefly summarize John 4:5–15, and testify that Jesus Christ and His gospel give life to our spirits, just as water gives life to our bodies.



Teach the Doctrine

Older Children

JOHN 2:1–11

I can honor my mother as Jesus did.

At the wedding in Cana, Mary told Jesus that the wine had run out. According to the Joseph Smith Translation, Jesus responded to His mother by asking, “Woman, what wilt thou have me to do for thee? that will I do” (John 2:4, footnote *a*). Jesus is an example of how the children should treat their mothers.

Possible Activities

- Invite the children to read John 2:1–11 and take turns retelling parts of it in their own words.
- Ask the children to list things their mother might need help with. Invite them to practice what they could say to her using some of Jesus’s words: “What wilt thou have me to do for thee?” (John 2:4, footnote *a*).
- Invite some mothers to visit your class and share what their children do to show respect for them.



Jesus said to his mother, “What wilt thou have me to do for thee?” (Joseph Smith Translation, John 2:4 [in John 2:4, footnote a]).

JOHN 3:1–8

Being baptized and confirmed is like being born again.

When we are baptized, which Jesus called being “born of water,” we receive a remission of our sins and can

“enter into the kingdom of God” (John 3:5). How can you help the children you teach understand what being born again means?

Possible Activities

- Scramble the Savior’s words in John 3:3 and let the children put them in the correct order. How is being baptized and confirmed like being born again?
- Display a picture of a newborn baby and of someone getting baptized and confirmed (see *Gospel Art Book*, nos. 104 and 105). How are we like a newborn baby after we are baptized and confirmed? (see John 3:3–5).
- Invite the children to share memories of their baptisms. Read Mosiah 18:8–10 and Doctrine and Covenants 20:37 to review the baptismal covenant. Teach the children that taking the sacrament thoughtfully every week is a way to continue the process of being born again.
- Help the children memorize Articles of Faith 1:4.

JOHN 3:16-17

Heavenly Father loves me, so He sent His Son.

How can you help the children know that Jesus Christ was sent to earth as an expression of Heavenly Father’s love?

Possible Activities

- Ask the children to draw a picture of their favorite gift and the person who gave them that gift. Then ask a child to read John 3:16. What gift did Heavenly Father give us? How does this gift show His love?

- Ask the children to listen for answers to the question, “Why did Heavenly Father send us Jesus Christ?” as they sing or listen to “He Sent His Son,” *Children’s Songbook*, 34–35.

JOHN 4:6-23

Jesus Christ offers me “living water.”

Just as Jesus used water to teach the woman of Samaria, you can use water to teach the children why we need the gospel of Jesus Christ.

Possible Activities

- Give the children a drink of water, and ask them to share experiences when they were thirsty. Talk about how it felt to finally get a drink of water.
- Write summary sentences from the story of the woman at the well, and ask the children to refer to John 4:6–23 to put the sentences in the correct order. What was Jesus trying to teach the woman?
- Draw on the board a cup of water and a spring or river. Invite the children to name things that, like a cup of water, satisfy us for the moment. What things are like “living water” that can satisfy us forever?
- Write on the board *How is the gospel like water?* Ask the children to think about how they would answer this question as they read John 4:6–23.



Encourage Learning at Home

Consider asking the children to give their family members a drink of water when they get home. As they do, they could share what they learned about living water.

Improving Our Teaching

Use activity pages. As the children complete activity pages, use the time to review principles from the lesson.

I need to be baptized and confirmed to return to live with God (John 3:1-8).

“Except a man be born of water and of the Spirit,

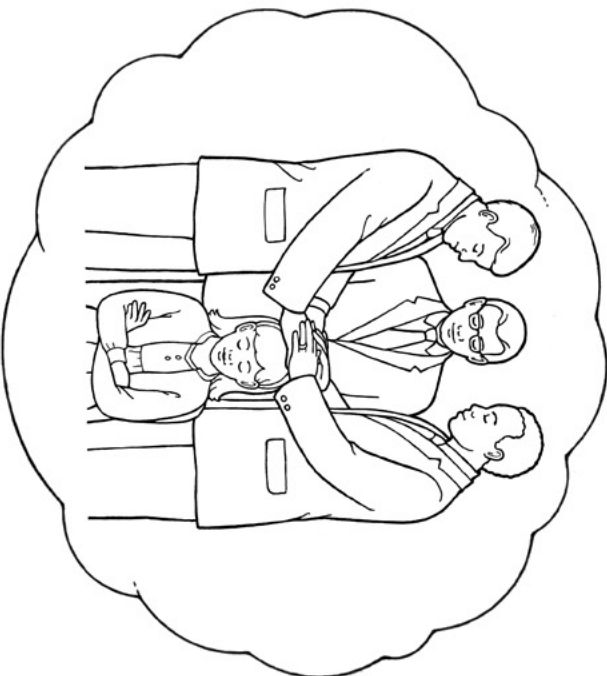
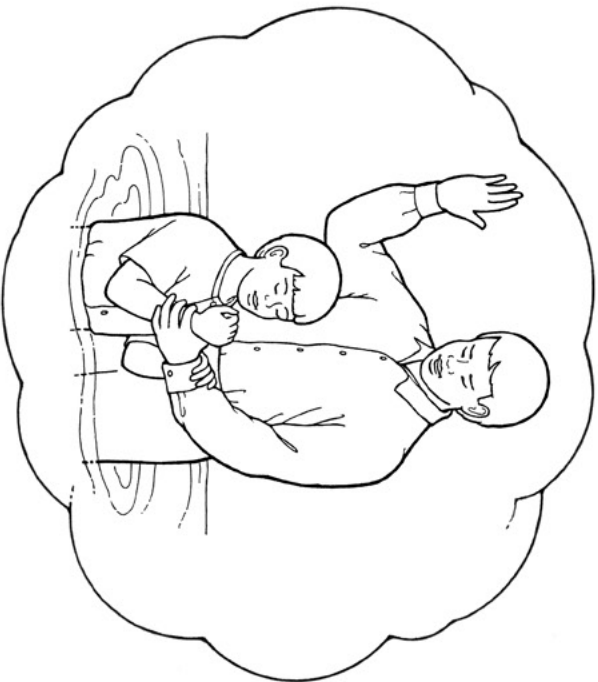

he cannot enter into the kingdom of God” (John 3:5).



Sermon on the Mount, by Jorge Cocco

FEBRUARY 18-24

Matthew 5; Luke 6

“Blessed Are Ye”

Start by reading Matthew 5 and Luke 6. *Come, Follow Me—For Individuals and Families* can help you understand these chapters, and this outline can give you teaching ideas.

RECORD YOUR IMPRESSIONS _____



Invite Sharing

Ask the children to talk about something they did this week to share the light of the Lord with someone.



Teach the Doctrine

Younger Children

MATTHEW 5:9

I can be a peacemaker.

The children you teach can have a powerful influence at home as they treat others with love and kindness.

Possible Activities

- Read Matthew 5:9 to the children, and explain that peacemakers make any place a peaceful place, no matter where they are. Share a few fictional scenarios, and help the children identify whether or not the people involved are being peacemakers.

- Invite a few of the children’s parents to visit your class and share examples of times when their children were peacemakers in the home.
- Write on strips of paper several difficult situations the children might face (for example, siblings fighting over a toy). Invite each child to pick a strip of paper. As you read the scenarios, ask them to share how they could be a peacemaker in that situation.

MATTHEW 5:14-16

Jesus wants me to be a light to others.

Little children can have a powerful influence for good on others. How can you inspire them to let their light shine?

Possible Activities

- Show the children several items that give light, including a picture of children. Read Matthew 5:14-16, and tell the children that we all have a light within us. How can we use our light to bring others to God?
- Shine a flashlight around the room. How does light help us? How can we be a light to the world? Cover

the flashlight. What happens if we don't share our light or if we hide it?

- Hide a flashlight in the room, and turn off the lights. Let the children try to find it. Review Matthew 5:15, and talk about why we shouldn't hide our light.
- Shine a flashlight on the wall, and invite the children to follow the light with their eyes. Use the light to lead their eyes to a picture of the Savior. Ask the children to share how we can be a light that leads others to Jesus Christ.
- Help the children find and color the hidden candles in this week's activity page.
- Sing with the children "Jesus Wants Me for a Sunbeam," "Shine On," or "I Am like a Star," *Children's Songbook*, 60–61, 144, 163.

MATTHEW 5:44–45

Jesus Christ wants me to love everyone.

Younger children can begin now to practice showing love, even when they are mistreated by peers or siblings. As you read Matthew 5:44–45, consider how the Savior's teachings apply to the children you teach.

Possible Activities

- Restate Matthew 5:44 using words and situations the children will understand and relate to. Ask the children to share times when they showed love for someone even though it was hard. How did these experiences make them feel?
- As a class, sing "I'll Walk with You," *Children's Songbook*, 140–41. What do we learn from this song about loving others?
- Give the children paper hearts labeled with the words "I will show my love for everyone." Ask them to decorate the hearts and hang them in their homes as a reminder to love others.
- Help the children learn the actions to go with "Love One Another," *Children's Songbook*, 136–37, as suggested in the *Children's Songbook*.



Teach the Doctrine

Older Children

MATTHEW 5:3–12

I can be happy when I live the way Jesus taught.

As you read Matthew 5:3–12, what words and phrases stand out to you? How will these teachings bless the lives of the children you teach?

Possible Activities

- Create a chart on the board with two columns, labeled *Blessed are . . .* and *Blessing*. Invite the children to search Matthew 5:3–12 for who Jesus says is blessed and the blessings He promises them.
- Write each of the qualities and their corresponding blessings from these verses on cards, and let the children match the qualities and the blessings. Ask the children to pick one of the qualities in these verses that they want to develop.

MATTHEW 5:9, 21–24, 38–47

I can be a peacemaker.

Jesus taught that peacemakers will be called the children of God. How can you inspire the children to be peacemakers?

Possible Activities

- Invite a child to read Matthew 5:9. Then ask: What is a peacemaker? What are ways we can be peacemakers with our families and friends? (For some ideas, see verses 21–24, 38–47.)
- Ask each child to think of a situation that would need the help of a peacemaker. What would a peacemaker do in the situation?
- Invite the children to share times when they showed love for someone, even if that person was different from them or was difficult to love.

MATTHEW 5:14–16**My example can light the way for others to follow Jesus.**

Think about the children you teach as you read these verses. What messages might the Lord have for the children in this passage?

Possible Activities

- Help the children memorize Matthew 5:16. Write the verse on the board. Read it together several times, erasing a few words each time. After the children have memorized the verse, you could also sing “Shine On,” *Children’s Songbook*, 144.
- Ask the children to draw things that give us light. Read Matthew 5:14–16. Ask them why Jesus wants us to be a light to the world.

- Invite the children to draw things they can do to be a light to others. You could show the video “Light the World: 25 Days of Service” (LDS.org). Invite two children to face each other, and ask one to try to make the other smile without touching him or her. Talk about the power the children have to bring happiness to others.



Encourage Learning at Home

Challenge the children to watch for someone being a peacemaker this week. At the beginning of next week’s class, invite them to talk about who and what they saw.

Improving Our Teaching

Help children be active. “As you teach children, allow them to build, draw, color, write, and create. These things are more than fun activities—they are essential to learning” (*Teaching in the Savior’s Way*, 25).

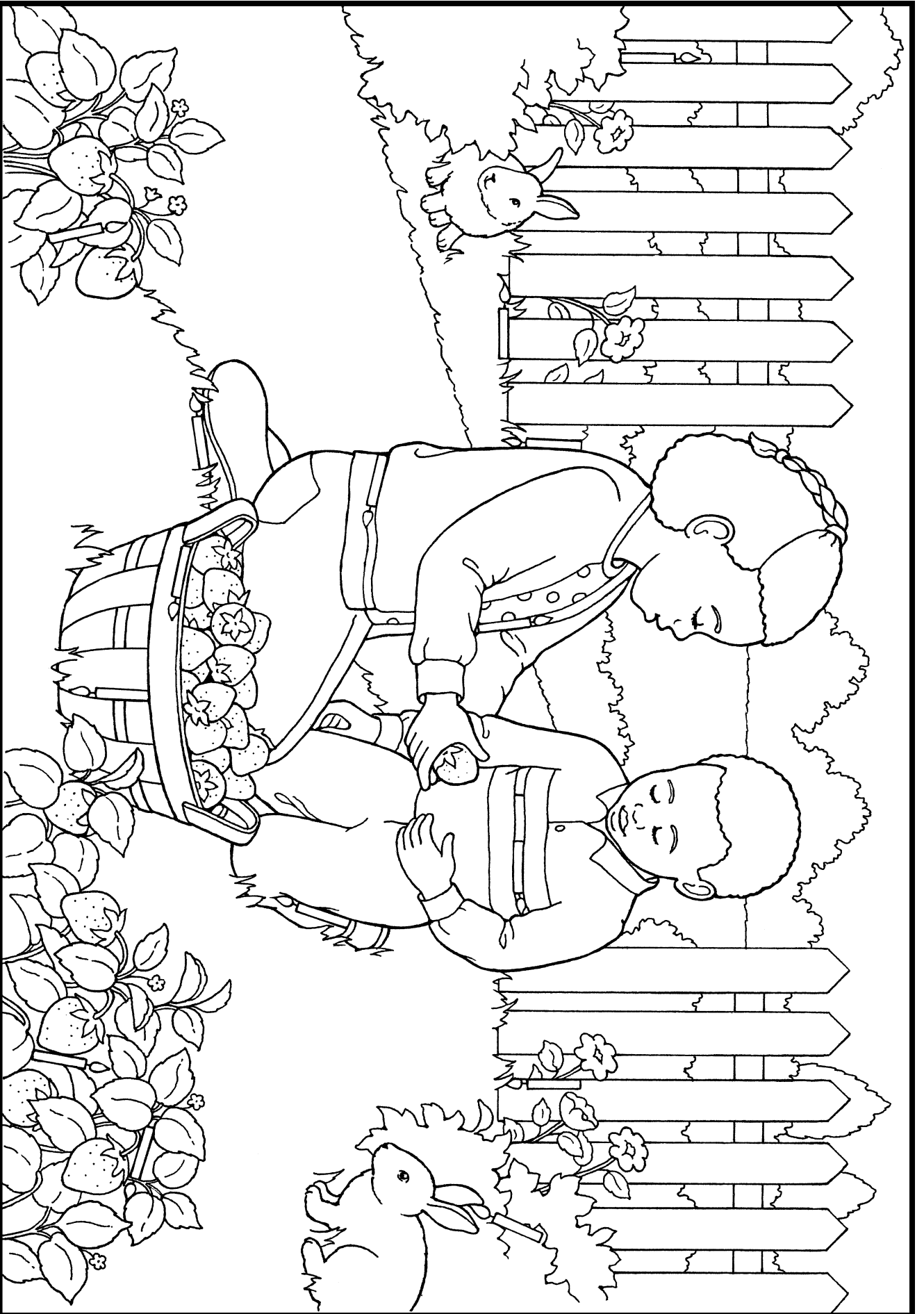

Jesus wants me to be a light to others (Matthew 5:14-16).

Find the 15 hidden candles.

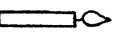



Jesus Teaching the People by the Seashore
by James Tissot

FEBRUARY 25–MARCH 3

Matthew 6–7

“He Taught Them as One Having Authority”

Start by reading Matthew 6–7 as you think about the children you teach. What messages from these chapters do they need to hear? *Come, Follow Me—For Individuals and Families* and this outline can help give you teaching ideas as needed.

RECORD YOUR IMPRESSIONS _____



Invite Sharing

Ask the children to share what they did during the past week to be a light or example for someone.

Teaches about Prayer,” *New Testament Stories*, 51–52, or the corresponding video (LDS.org).

- Use this week’s activity page to help the children remember the different parts of prayer.
- Trace each child’s hand on a piece of paper. Talk about what we should do with our hands and arms while we pray. On each tracing, write something we do to show reverence when we pray (for example, bowing our heads, closing our eyes, and so on).
- Help the children make a poster or chart that will help them remember to pray morning and night, and invite them to share it with their families.
- Sing a song about prayer with the children (such as “We Bow Our Heads,” *Children’s Songbook*, 25), and bear your testimony of the power of prayer. You could also invite the children to share their experiences with prayer.



Teach the Doctrine Younger Children

MATTHEW 6:5–13

I can pray to my Heavenly Father as Jesus did.

Children can learn to pray by listening to others’ prayers. How can you help them learn from Jesus Christ’s prayer in these verses?

Possible Activities

- Review Jesus’s teachings about prayer found in Matthew 6:5–13. You might use “Chapter 20: Jesus



I can pray to my Heavenly Father as Jesus did.

MATTHEW 7:12

I should treat others the way I want to be treated.

Jesus’s teaching in Matthew 7:12—also known as the Golden Rule—provides a simple guide for how to treat others. What will help the children you teach live by this principle?

Possible Activities

- Read Matthew 7:12, and paraphrase it in simple words that the children can understand. Help the children think of several ways to complete a sentence like the following: “I like it when others _____ for me.” After each sentence, invite them to repeat with you, “So I should _____ for others.”
- Sing with the children “Jesus Said Love Everyone,” *Children’s Songbook*, 61, and make up simple actions to accompany the song. Ask the children what they learn about how we should treat others from the Savior’s example.
- Invite the children to list kind things their parents or other family members do for them. Read Matthew 7:12, and invite the children to make a list of kind things they can do for their families.

MATTHEW 7:24–27

I can build on a strong foundation by following Jesus.

Using the Savior’s parable about building a house on sand or on a rock can be a memorable way to teach children about the importance of acting on what we learn.

Possible Activities

- Sing with the children “The Wise Man and the Foolish Man,” *Children’s Songbook*, 281, and use actions to go along with the words.
- Use Matthew 7:24 to teach about the differences between the wise man and the foolish man. Invite the children to pretend they are building a house. How can we be like the wise man?
- Let the children draw pictures of the parable of the wise man and the foolish man.



Teach the Doctrine
Older Children

MATTHEW 6–7

The Sermon on the Mount contains messages for me.

These chapters have many messages that could apply to the children you teach. Read them with the children in mind. What stands out to you?

Possible Activities

- Remind the children that they have been learning about what Jesus taught during the Sermon on the Mount. What truths can they remember learning about last week?
- Write on the board some phrases from the Sermon on the Mount and some other phrases that are not from the scriptures. Invite the children to identify which phrases come from the Sermon on the Mount and share what they learn from them.

- Select several verses from Matthew 6–7 that you feel will be meaningful to the children. Write the scripture references on cards, and hide them throughout the room. Let the children find them, read the verses, and explain why these teachings are important to them.
- Share a favorite passage from Matthew 6–7, and explain why you like it. If the children have a passage they like, invite them to share why they like it and what they learn from it.
- Sing “I’m Trying to Be like Jesus,” *Children’s Songbook*, 78–79, with the children and stop the song when you come to a phrase that relates to a principle taught in Matthew 6–7 (such as “learning to serve my friends”). Help the children make connections to things they are learning from these chapters.

MATTHEW 6:5-13; 7:7-11

Heavenly Father will hear and answer me when I pray.

As you study Matthew 6:5–13; 7:7–11, what do you feel the children need to understand about prayer?

Possible Activities

- Invite the children to read Matthew 6:9–13 out loud and then list things the Savior said in His prayer. How can we follow His example when we pray?
- Sing a song about prayer with the children, such as “Did You Think to Pray?” *Hymns*, no. 140. Help the children search the lyrics to find reasons we pray and blessings that come from prayer.
- Help the children memorize Matthew 7:7 by playing a game like the following: One child recites the first

word or phrase from the verse and then tosses a ball to another child, who then recites the next word or phrase.

- Act out Matthew 7:9–10 with the children using simple props. Ask the children to share what this teaches them about prayer.
- Share an experience in which your prayers were answered.

MATTHEW 6:19-21

I can seek eternal treasures instead of earthly treasures.

How will you help the children you teach place greater value on eternal things than on worldly things?

Possible Activities

- Bring a “treasure” box filled with objects or pictures that represent things the world values—for example, money or toys. Read Matthew 6:19–21 together, and then ask the children to help you think of heavenly treasures that could replace the worldly items in the box.
- Invite the children to name or draw some things they could do to “lay up . . . treasures in heaven” (Matthew 6:20).



Encourage Learning at Home

Invite the children to share with their families their favorite teaching from the Sermon on the Mount.

Improving Our Teaching

Seek to understand your class members. You know the children you teach. The ideas in these outlines may need to be modified to best address the needs of your class. You may want to review all the activities listed in this outline, not just the activities designated for the age of children you teach, in order to find ideas for your class. (See *Teaching in the Savior’s Way*, 7.)

I can pray to my Heavenly Father as Jesus did (Matthew 6:5-13).

Color the pictures on the circle. Cut out the circle and arrow, and attach the arrow to the center of the circle.
Move the arrow around the circle to learn things we do and say when we pray.

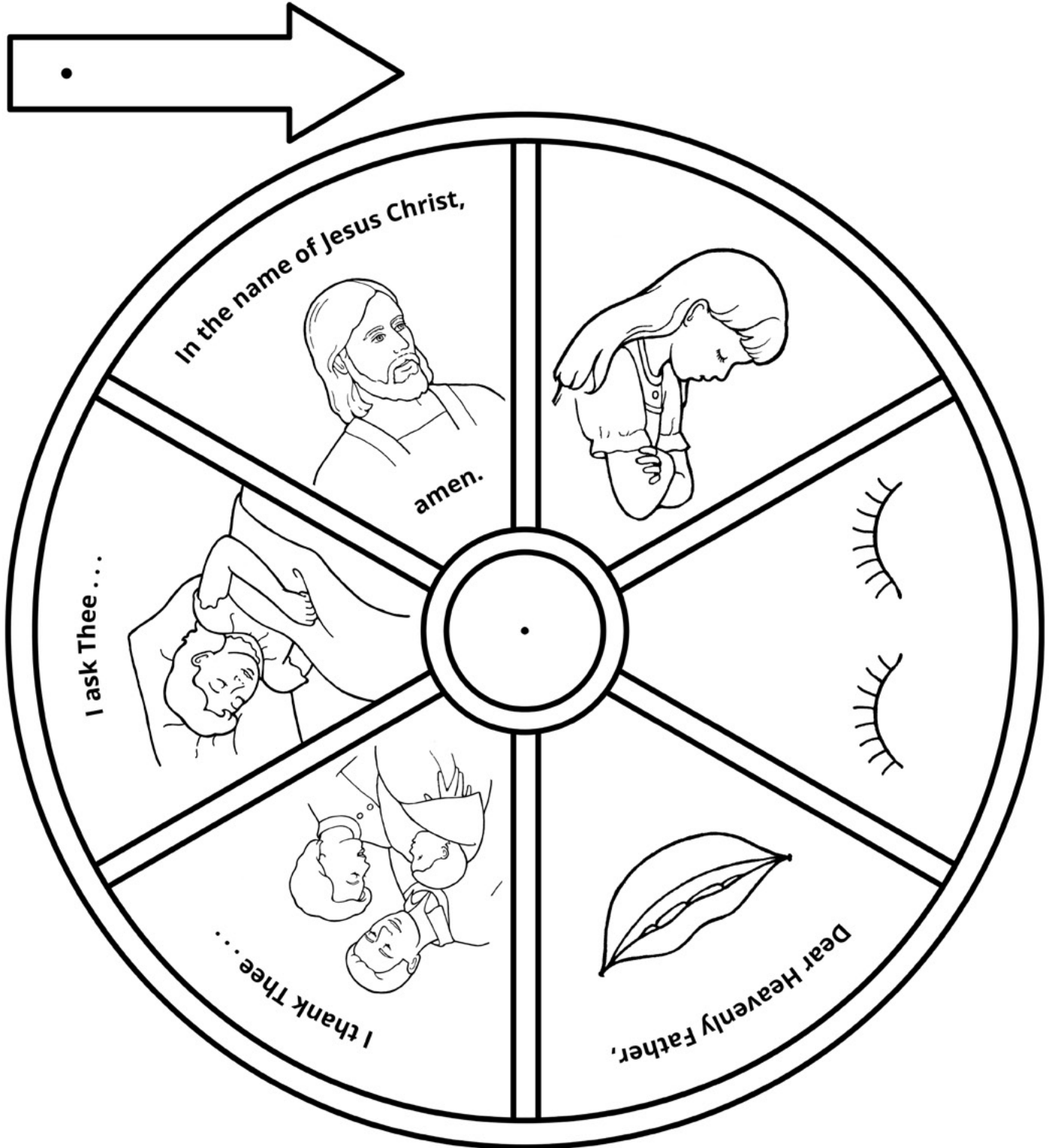



Healing in His Wings, by Jon McNaughton

MARCH 4–10

Matthew 8–9; Mark 2–5

“Thy Faith Hath Made Thee Whole”

Start by reading Matthew 8–9 and Mark 2–5. *Come, Follow Me—For Individuals and Families* can help you understand these chapters, and this outline can give you teaching ideas.

RECORD YOUR IMPRESSIONS _____



Invite Sharing

Ask the children to share a story of Jesus performing a miracle (see the list of miracles in this week’s outline in *Come, Follow Me—For Individuals and Families*). You could also show related pictures (see *Gospel Art Book*, nos. 40, 41, or LDS.org).



Teach the Doctrine Younger Children

MATTHEW 8–9; MARK 2; 5

Jesus has power to perform miracles.

As you read about the Savior’s miracles of healing, ponder which miracles to share. How can you help the children you teach understand the role of faith in the miracles Jesus performed?

Possible Activities

- Share the account of the man with palsy from Mark 2:1–12. For help, see “Chapter 23: The Man Who

Could Not Walk,” *New Testament Stories*, 57–58, or the corresponding video (LDS.org). Tell the children that the man with palsy could not walk. Help them recognize that this man was healed and forgiven by the Savior.

- Invite the children to pretend they are “waking up” like the daughter of Jairus as you read from Mark 5:22–23, 35–43. Help them understand that Jesus has made it possible for all of us to have eternal life.
- Read Mark 5:34. Help the children memorize the phrase “Thy faith hath made thee whole,” perhaps by giving each child a word and then having the children say their words in order. Has anyone they know ever been healed when they were sick?
- Ask the children to close their eyes and listen as you read from Matthew 9:27–30. When you read about Jesus healing the blind men, invite the children to open their eyes. How would the children feel if Jesus had healed them?
- Invite the children to talk about a time when they were sick. Tell one of the accounts of Jesus healing the sick, and testify that Jesus’s power can heal and bless us as we pray and receive priesthood

blessings. Explain that although the Lord sometimes does not give us the miracles we desire, He loves us and is aware of our needs. He will give us the comfort we need.

MARK 4:35–41

When I am afraid or in danger, Jesus can help me feel peace.

The account of Jesus calming a storm can help children know that He can give them peace when they feel afraid.

Possible Activities

- Help the children imagine that they are on the ship as you read Mark 4:35–41. (See also “Chapter 21: Jesus Commands the Winds and the Waves,” *New Testament Stories*, 53, or the corresponding video on LDS.org.) Ask the children to describe how they might have felt if they had been there. When have the children been scared? How did they find comfort?
- Invite the children to make the sounds of a storm and stop when someone says “Peace, be still.” Testify that just as Jesus can bring us peace when there is a storm outside, He can bring us peace in our hearts when we feel bad on the inside.
- Think of actions to accompany the third verse of “Tell Me the Stories of Jesus,” *Children’s Songbook*, 57.



Christ Stilling the Storm, by Robert T. Barrett



Teach the Doctrine

Older Children

MARK 2; 5

Jesus can perform miracles in my life as I have faith in Him.

Jesus performed many miracles during His mortal ministry. How can you help the children be aware that miracles happen today?

Possible Activities

- Ask the children to pick one of the following miracles to read about and draw: Mark 2:1–12; Mark 5:22–23, 35–43; or Mark 5:24–34. Invite the children to explain their drawings to the class. What do they learn about Jesus from these stories?
- Ask the children to act out how they feel when they are sick, sad, afraid, or worried. How can Jesus help us when we have these feelings? Testify that Jesus can help the children in all of these situations.
- Invite the children to share experiences when they or someone they know received a priesthood blessing. How was that person healed or blessed?

MATTHEW 8–9; MARK 2; 5

I can show love for others as Jesus did.

Jesus showed great love by healing the sick and afflicted. Ponder how you can teach the children to show compassion for people in need.

Possible Activities

- Choose one or more of Jesus’s miracles to review with the children, such as those in Mark 2:1–12; Mark 5:22–23, 35–43; or Mark 5:24–34. (See also the videos “Jesus Forgives Sins and Heals a Man Stricken with Palsy,” “Jesus Raises the Daughter of Jairus,” and “Jesus Heals a Woman of Faith” on LDS.org.) Invite the children to share a time when they helped someone in need and how they felt.

- Show the video “Gordon Hinckley: Lessons I Learned as a Boy” or “The Coat” (LDS.org). How did the boys in these videos follow Jesus’s example? Invite the children to share other situations when someone might be in need. What can we do to help them?
- Remind the children that helping others is part of their baptismal covenants (see Mosiah 18:8-10; Alma 34:28).
- Invite the children to share experiences when they felt peace after praying for help. Remind them that this peace comes from the Savior.
- Sing “Master, the Tempest Is Raging,” *Hymns*, no. 105, with the children, inviting them to whisper when they sing “Peace, be still.”
- Give each child a paper rain cloud, and ask them to write on it a trial that someone might have. Put all of the clouds on the board, covering a picture of the Savior. Invite a child to remove one of the clouds and suggest ways we could help someone with that trial to find peace. When all the clouds are removed, testify of the Savior’s power to calm the storms in our lives.

MATTHEW 8:23-27; MARK 4:35-41

When I am afraid or in danger, Jesus can help me feel peace.

Children need to know that the Savior can give them peace when they face the storms of life—now and in the future.

Possible Activities

- Ask one of the children to use Mark 4:35-41 and the picture Jesus Calms the Storm (*Gospel Art Book*, no. 40) to tell the story of Jesus calming the storm. Ask the children to describe how they might have felt if they had been there.



Encourage Learning at Home

Help the children write down an act of service they will perform for someone this week.

Improving Our Teaching

Children are active. At times you may feel that the children’s energy is a distraction from learning. But you can build on their active natures by inviting them to act out a story or perform actions that correspond with events in a song or scripture. (See *Teaching in the Savior’s Way*, 25.)

Fold

Fold

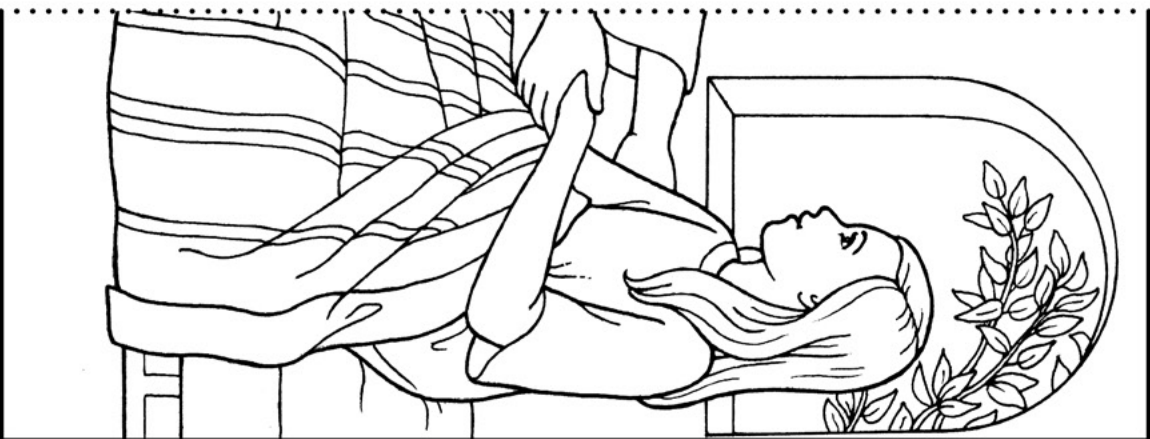

Jesus has the power to perform miracles that bless me (Matthew 8-9; Mark 2; 5).

Color the pictures, and then fold the page on the dotted lines.

Open and close the folds to show Jesus healing Jairus's daughter.





MARCH 11-17

Matthew 10–12; Mark 2; Luke 7; 11

“These Twelve Jesus Sent Forth”

As you read Matthew 10–12; Mark 2; and Luke 7; 11, you will receive promptings from the Holy Spirit that will help you prepare. These promptings, along with *Come, Follow Me—For Individuals and Families* and this outline, can help in your preparation.

RECORD YOUR IMPRESSIONS _____



Invite Sharing

Encourage the children to share how they keep the Sabbath day holy.



Teach the Doctrine Younger Children

MATTHEW 10:1-10

Jesus called twelve Apostles and gave them power to do His work.

Do the children you teach know that we have twelve Apostles today? How can you use these verses to teach them about the importance of modern-day Apostles and what they are called to do?

Possible Activities

- Summarize Matthew 10:1–10 in simple terms. (See Christ Ordaining the Apostles, *Gospel Art Book*,

no. 38.) Explain that Jesus calls Apostles to help Him build His Church.

- Let the children count the Apostles in the picture Christ Ordaining the Apostles (*Gospel Art Book*, no. 38) and in a picture of the current Quorum of the Twelve Apostles (see LDS.org or a general conference issue of the *Ensign* or *Liahona*). Explain that we have twelve Apostles today, just as in Jesus’s time.
- Hide pictures of the modern-day Apostles around the room (for pictures, see a recent general conference issue of the *Ensign* or *Liahona*). Invite the children to find the pictures, and tell them a little about each Apostle (see “Meet Today’s Prophets and Apostles” on LDS.org).
- Invite a child to hold up a picture of the First Presidency and a picture of the Quorum of the Twelve Apostles. Ask the child to lead the other children around the room to a picture of Jesus. Testify that the prophets and apostles lead us to Jesus Christ.
- Share your testimony of the Lord’s Apostles.



The Twelve Apostles perform the Lord's work today.

MATTHEW 11:28-30

Jesus will help me as I come unto Him.

Children can feel comfort knowing that Jesus will help them with their burdens when they come to Him.

Possible Activities

- Read Matthew 11:28-30 and show the picture of yoked oxen in this week's outline in *Come, Follow Me—For Individuals and Families*. Point out that yoked oxen can pull more weight together than if they pull separately. Testify that when we feel sad, worried, or scared, we can seek Jesus and He will help us.
- Ask a child to lift a heavy object. When he or she struggles, offer to help. How does Jesus help us do hard things? Have the children ever felt His help?

MATTHEW 12:1-13

I can keep the Sabbath day holy.

What are some fun ways you can teach the children about the Sabbath day and why we keep it holy?

Possible Activities

- Read Matthew 12:10-13 out loud. Invite the children to stand up and sit down every time you say "Sabbath," and repeat with them the phrase "It is [right] to do well on the sabbath days" (Matthew 12:12). What do they think that means?

- Show a calendar to the children and highlight the Sabbath day for them. What do we do on other days of the week? What can we do on the Sabbath to make it different from other days? (see Isaiah 58:13-14).
- Ask the children to draw good things they can do on the Sabbath day (see this week's activity page).
- Invite the children to come up with actions to help them remember ways we get ready for the Sabbath as they sing the song "Saturday," *Children's Songbook*, 196.
- Draw eyes, ears, a mouth, and hands on the chalkboard. Ask the children to tell you what each of these parts of our bodies can do to keep the Sabbath day holy.



Teach the Doctrine
Older Children

MATTHEW 10:1-10; MARK 3:13-19

The Twelve Apostles can teach me about Jesus.

How can learning about the Twelve Apostles in Christ's day help the children better understand what the Twelve Apostles do today?

Possible Activities

- Show pictures of the Apostles in Jesus's time and in our day (see *Christ Ordaining the Apostles*, *Gospel Art Book*, no. 38, and a recent conference issue of the Church magazines). Ask the children to read Matthew 10:1-10 and Mark 3:14-15 to find out what Apostles do.
- Invite a few children to come prepared to share a story told by one of the living Apostles. How are the living Apostles helping us become more like the Savior?
- Write the names of the modern-day Apostles on pieces of paper. Invite the children to match each

Apostle's name with his picture (LDS.org). This activity could be repeated several times.

- Share several examples of modern-day Apostles' testimonies of Christ with the children (see recent general conference messages or "The Living Christ: The Testimony of the Apostles," *Ensign* or *Liahona*, Apr. 2000, 2).
- Help the children memorize and understand Articles of Faith 1:6.

MATTHEW 11:28–30

Jesus will help me as I come unto Him.

How can you help the children understand that the Savior will give them rest from their challenges as they come unto Him?

Possible Activities

- Invite the children to share a time when they were worried or anxious about something. Invite them to search Matthew 11:28–30 for counsel that can help them in similar circumstances.
- Invite the children to draw pictures of what they are doing to come unto Jesus and learn of Him. The fourth article of faith could give them ideas.

MATTHEW 12:1–14

The Sabbath is a day to do good things that bring me closer to God.

The children you teach will be strengthened as you emphasize the purposes and blessings of keeping the Sabbath day holy.

Possible Activities

- Invite a child to role-play the man whose hand was healed by the Savior (see Matthew 12:10–13). Another child could interview him or her about the experience.
- Read together Matthew 12:12. What are some good things we can do on the Sabbath? Let the children draw their ideas on this week's activity page, cut out the pieces, and take turns putting each other's puzzles together.
- Hide several pictures of people doing things that show love for Heavenly Father on the Sabbath day. Ask the children to find the pictures and share how doing the things in the pictures shows our love for God.
- Give each child a bag to fill with ideas of good things to do on the Sabbath. They can find some ideas in "Sabbath Day Observance" in *For the Strength of Youth*, 30–31.



Encourage Learning at Home

Invite the children to share with their families ideas to keep the Sabbath day holy.

Improving Our Teaching

Encourage reverence. Help the children understand that an important aspect of reverence is thinking about Heavenly Father and Jesus Christ. You might remind the children to be reverent by quietly singing or humming a song or displaying a picture of Jesus.

The Sabbath is a day to do good things that bring me closer to God (Matthew 12:10-12).

Draw a good thing that you can do on the Sabbath in the space below.

Cut out the puzzle pieces, and then put the puzzle together.

I will
KEEP THE SABBATH DAY HOLY.

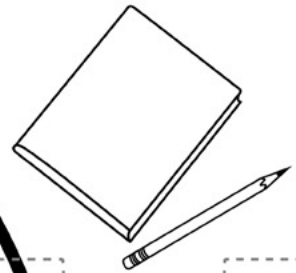



MARCH 18-24

Matthew 13; Luke 8; 13

“Who Hath Ears to Hear, Let Him Hear”

Parables are simple stories that can be engaging for children. This outline and *Come, Follow Me—For Individuals and Families* can help you use the Savior’s parables to teach children important truths.

RECORD YOUR IMPRESSIONS _____



Invite Sharing

Bring several items that could help the children remember some of the parables in Matthew 13, such as a seed, a pearl, or a treasure box. Invite the children to share what they remember about the parables.

you help them better understand how this parable relates to them?



Teach the Doctrine

Younger Children

MATTHEW 13:1-23

I need to prepare to learn the teachings of Jesus.

Younger children may not be able to understand all of the symbolism in the parable of the sower, but they can learn the simple gospel truths it teaches. How can

Possible Activities

- Display different kinds of soil (or pictures of soil) as you summarize Matthew 13:3–8. Give each child a seed to plant in soil. Ask the children what we can do to help our seeds grow. Explain that having faith in Heavenly Father and Jesus Christ is one way we help our testimony “seed” grow.
- Use this week’s activity page to help the children understand what each type of soil described in Matthew 13 teaches about our hearts. Ask the children which type of heart Jesus wants them to have in order to learn His teachings.
- Read Matthew 13:9, 15, and invite the children to point to different parts of their body when they hear them mentioned. How can we use these body parts to learn the teachings of Jesus?

MATTHEW 13:24–30, 36–43, 47–48**Heavenly Father wants me to choose the right.**

Some of Jesus’s parables teach that at the last day, God will separate the wicked from the righteous. How can you use the parables to inspire the children to choose the right?

Possible Activities

- Let the children act out the parable of the wheat and the tares (see Matthew 13:24–30). Explain that the wheat represents people who make righteous choices, and the tares (harmful weeds) represent people who do not. One day, Heavenly Father will gather the righteous people to live with Him.
- Tell some simple stories of children making choices. Ask the children to say “wheat choice” when the children in the stories choose the right and “tare choice” when the children make a wrong choice.
- Bring pictures of stalks of wheat, and let the children draw on the pictures some ways they can be righteous.
- Create a game in which children match details from the parable of the sower with the interpretation in Matthew 13:18–23.

MATTHEW 13:44–46**My membership in The Church of Jesus Christ of Latter-day Saints is a treasure.**

How can you use the imagery of treasure and precious pearls to help the children understand the value of belonging to Christ’s Church?

Possible Activities

- Hide pictures of a treasure chest and a pearl in the room, and let the children find them. Use the pictures to help you teach about the parables in Matthew 13:44–46. What would the children give to have a beautiful pearl or treasure in a field? Explain that sometimes we give up something good for

something better. Tell the children why the gospel is valuable to you.

- Place in a box or chest several objects or pictures that represent “treasures” in The Church of Jesus Christ of Latter-day Saints, such as temples or the Book of Mormon. Ask each child to choose an object or picture and talk about why it is a treasure.
- Sing together “The Church of Jesus Christ,” *Children’s Songbook*, 77, and ask the children to listen for blessings that come from being a member of the Church. Testify of the blessings you’ve experienced because of your membership in the Church.



Teach the Doctrine

Older Children

MATTHEW 13:1–23**I need to prepare my heart to receive the teachings of Jesus.**

How can you help the children recognize the importance of having a soft and willing heart so that Jesus can teach them?

Possible Activities

- Assign each child to read about one of four types of soil in Matthew 13:4–8. Invite them to look for and share what happens to the seed in the type of soil they read about. How can our hearts be like the different types of soil? (see Matthew 13:19–23).
- Give each of the children two seeds, and invite them to plant their seeds in soft soil and in a pile of rocks. Which seed will have a better chance of growing? How can we make sure our hearts are like the soft soil so that we can receive the Savior’s teachings?
- Invite the children to read Matthew 13:9–17. Draw an eye, ear, and heart on the board. How do we use each of these body parts to learn the teachings of Jesus?

MATTHEW 13:24–30, 36–43**I can choose the right even when those around me do not.**

When you read these verses with the children in mind, what impressions come to you?

Possible Activities

- Invite the children to draw different scenes from the parable of the wheat and the tares, found in Matthew 13:24–30, and share their drawings with the class. Ask them to label their drawings using the interpretation of the parable found in Matthew 13:36–43. Explain that tares are harmful weeds.
- If possible, display a picture of wheat and tares. Explain that the wheat and tares will grow together until the end of the world. This teaches us that we live with both good and evil around us, and we must be careful to choose the right. Ask the children to share how they can tell the difference between good and evil.

MATTHEW 13:44–46**My membership in The Church of Jesus Christ of Latter-day Saints is a treasure.**

Do the children you teach see their membership in the Church as a valuable treasure? Perhaps the parables in Matthew 13:44–46 can help them.

Possible Activities

- Invite the children to read Matthew 13:44–46 to themselves and share the parables in their own words with another class member.
- Cut out several circles to represent coins, and put them in a treasure box. Invite the children to pick a coin and draw or write on it one thing they love about being a member of the Church. Ask the children to share what they put on their coin.
- Invite a ward member to share his or her conversion story with the children and tell what he or she sacrificed to join The Church of Jesus Christ of Latter-day Saints.

**Encourage Learning at Home**

Invite the children to teach their families about one of the parables they learned in Primary.

Improving Our Teaching



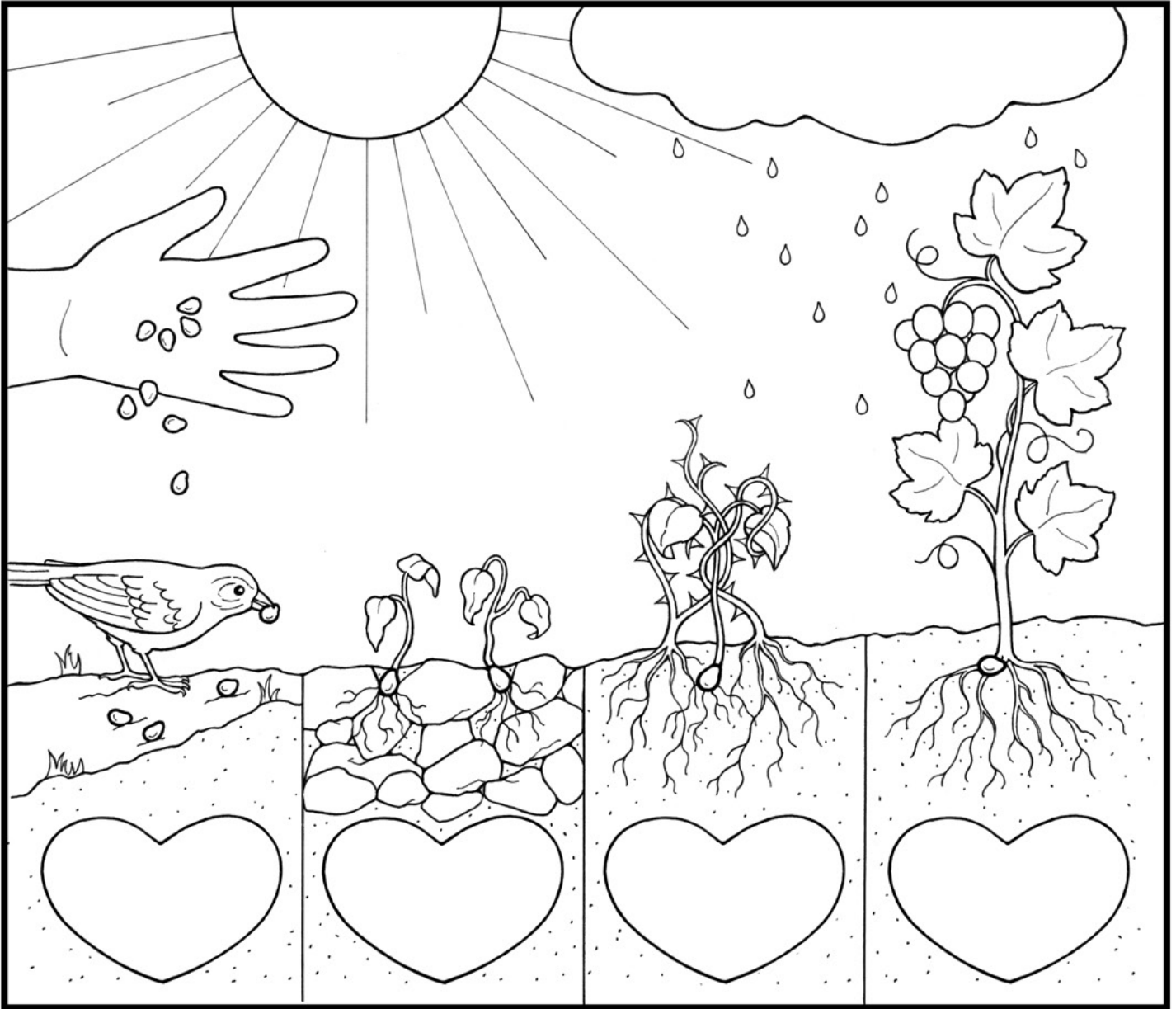

Children like to share what they are learning. Although they are young, children can strengthen their family members. Encourage them to share with their families the things they learn in Primary. (See *Teaching in the Savior's Way*, 30.)

I need to be ready to learn the teachings of Jesus (Matthew 13:1-23).

Color each part of the picture as you read the parable of the sower
in Matthew 13:1-8. Match the hearts in the soil with the interpretations in the key.



Key

-  Heard God's word but did not understand (Matthew 13:19).
-  Heard God's word but was offended (Matthew 13:20-21).
-  Heard God's word but became worldly (Matthew 13:22).
-  Heard God's word and understood it (Matthew 13:23).



Feed Them, by Jorge Cocco

MARCH 25-31

Matthew 14-15; Mark 6-7; John 5-6

“Be Not Afraid”

As you prepare to teach from Matthew 14-15; Mark 6-7; and John 5-6, look for messages that are relevant to the lives of the children you teach. What do you think will help them understand these messages? This outline may give you some ideas.

RECORD YOUR IMPRESSIONS _____



Invite Sharing

Show a picture of Jesus walking on the water (see this week’s outline in *Come, Follow Me—For Individuals and Families*), and ask the children to share what they know about the story.



Teach the Doctrine

Younger Children

JOHN 5:1-9

Jesus Christ knows what we need and can help us.

As you read about Jesus healing the man at the pool of Bethesda, ponder how you can help the children see what the story teaches about Jesus’s kindness, love, and other attributes.

Possible Activities

- Use the picture Christ Healing the Sick at Bethesda (*Gospel Art Book*, no. 42) to tell the children the story in John 5:1-9. Or show the video “Jesus Heals a Man on the Sabbath” (LDS.org). Ask the children to imagine that they are the person Jesus healed. How would they feel when Jesus healed them?
- Ask the children to name some things that are hard for them or that make them sad. Tell them about a time in your life when you received help from the Savior during a difficult trial. Testify that Jesus knows about all our problems and wants to help us.

MATTHEW 14:13-21

We follow Jesus’s example when we are kind to others.

One way Jesus showed love was to feed His followers when they were hungry. How can you help the children learn to serve others like Jesus did?

Possible Activities

- Show the children a basket and some bread as you tell the story in Matthew 14:13–21. Explain that even though Jesus had tried to find a place to be alone, the people wanted to be near Him. Share the rest of the story with the children, and ask them to listen for what Jesus did to show kindness and love for them.
- Ask the children to share ways in which someone has been kind to them. What can they do this week to be kind to others? For every answer they give, draw a loaf of bread or a fish on the board. Tell the children that when they do these things, they are following the example Jesus set when He fed the five thousand people who were hungry.

MATTHEW 14:22–33

Faith in Jesus Christ can help us not be afraid.

Peter showed great faith when he walked on the water toward Jesus. What lessons might there be for the children in this story?

Possible Activities

- Show the picture Jesus Walking on the Water (*Gospel Art Book*, no. 43) as you tell the story in your own words. Consider using this week's activity page to help the children tell the story back to you. You could also bring a small bowl of water and invite the children to pretend to "walk" their fingers across the surface of the water.
- Show the video "Wherefore Didst Thou Doubt?" (LDS.org), and ask the children to watch for what caused Peter to be afraid. Then ask them to tell about times when they felt afraid and share what helped them. Help them see that faith in Jesus Christ helps us overcome fear.



Teach the Doctrine

Older Children

JOHN 5:17–47

Jesus Christ teaches us about Heavenly Father.

How can Jesus's teachings about His Father help the children learn about Heavenly Father?

Possible Activities

- Create two sets of matching cards labeled with words that Jesus used to teach about Heavenly Father in John 5, such as *love*, *life*, and *works* (see John 5:20, 26, 36). Lay the cards face down, and ask the children to look for matches by flipping over two cards at a time. As each match is made, read the verse that contains the word, and ask the children what the word teaches us about Heavenly Father.
- Ask the children to read John 5:30, and then complete this sentence: "I seek not mine own will, but . . ." How did Christ do the will of His Heavenly Father? How can we do Heavenly Father's will?

JOHN 6:5–14

Our small offerings can make a difference.

It was a young boy who provided the bread and fish that Jesus used to feed the five thousand. How can you help the children you teach see how they can contribute to the work of the Lord?

Possible Activities

- Divide a few crackers or pieces of bread among the children. Help them imagine how large a crowd of five thousand people would be. What would it be like to feed that many people with only five loaves of bread and two fish?
- Invite a child to tell the story of the feeding of the five thousand in his or her own words. How can we

be like the boy in John 6:9? Invite the children to draw loaves and fish on paper and write on them some things they can give to the Lord to help in His work.

- Give the children a small puzzle to complete. What would happen if one of the pieces of the puzzle were missing? Explain that we are each like a puzzle piece—we all have something important to contribute to the lives of others. How do the children contribute to their families or class?



Jesus miraculously fed 5,000 people with five loaves and two fishes.

MATTHEW 14:22-33

Faith in Jesus Christ can help us not be afraid.

Faith and fear play prominent roles in the story of Jesus and Peter walking on the sea. What can children learn from this story?

Improving Our Teaching

Invite sharing. Ask the children about their thoughts, feelings, and experiences. You will find that they often have simple yet profound insights.

Possible Activities

- Show the picture in this week's outline in *Come, Follow Me—For Individuals and Families*. Ask the children to find a verse in Matthew 14 that describes the picture.
- Ask the children to look for signs of faith and signs of fear as they read Matthew 14:22-33. You could also show the video "Wherefore Didst Thou Doubt?" (LDS.org). What does it mean to have faith in Jesus Christ? How do we replace fear with faith?
- Ask the children to imagine they were present and had a camera when Jesus and Peter walked on the sea. Which moment would they choose to photograph and why? Suggest that they search Matthew 14:22-33 for ideas. Invite them to draw a picture of the moment they chose, share their pictures, and explain why they chose that moment.



Encourage Learning at Home

If the children completed this week's activity page, invite them to use it to teach their families what they learned today.

Jesus Christ can help me not to be afraid (Matthew 14:22-33).

Cut out the figure of Peter, and then glue it to a stick. Cut a slit along the dotted line in the picture.

Insert Peter in the slit and move him up and down as you tell the story of Jesus and Peter walking on the water.

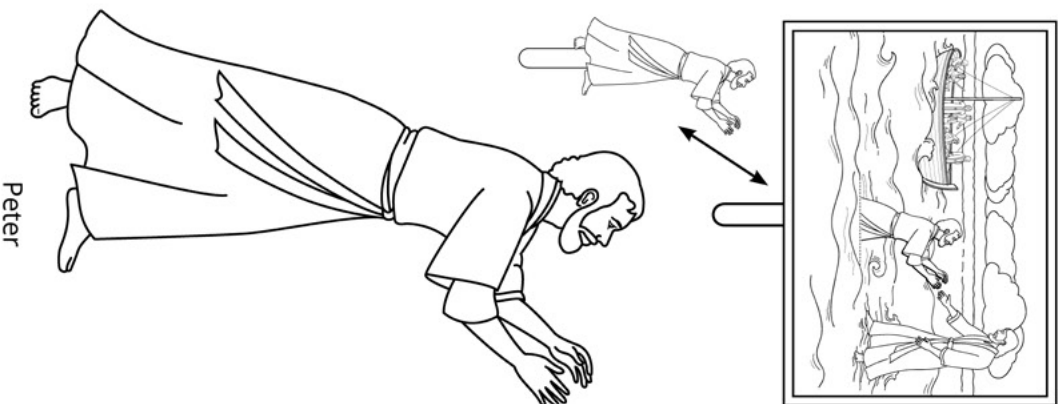

Peter

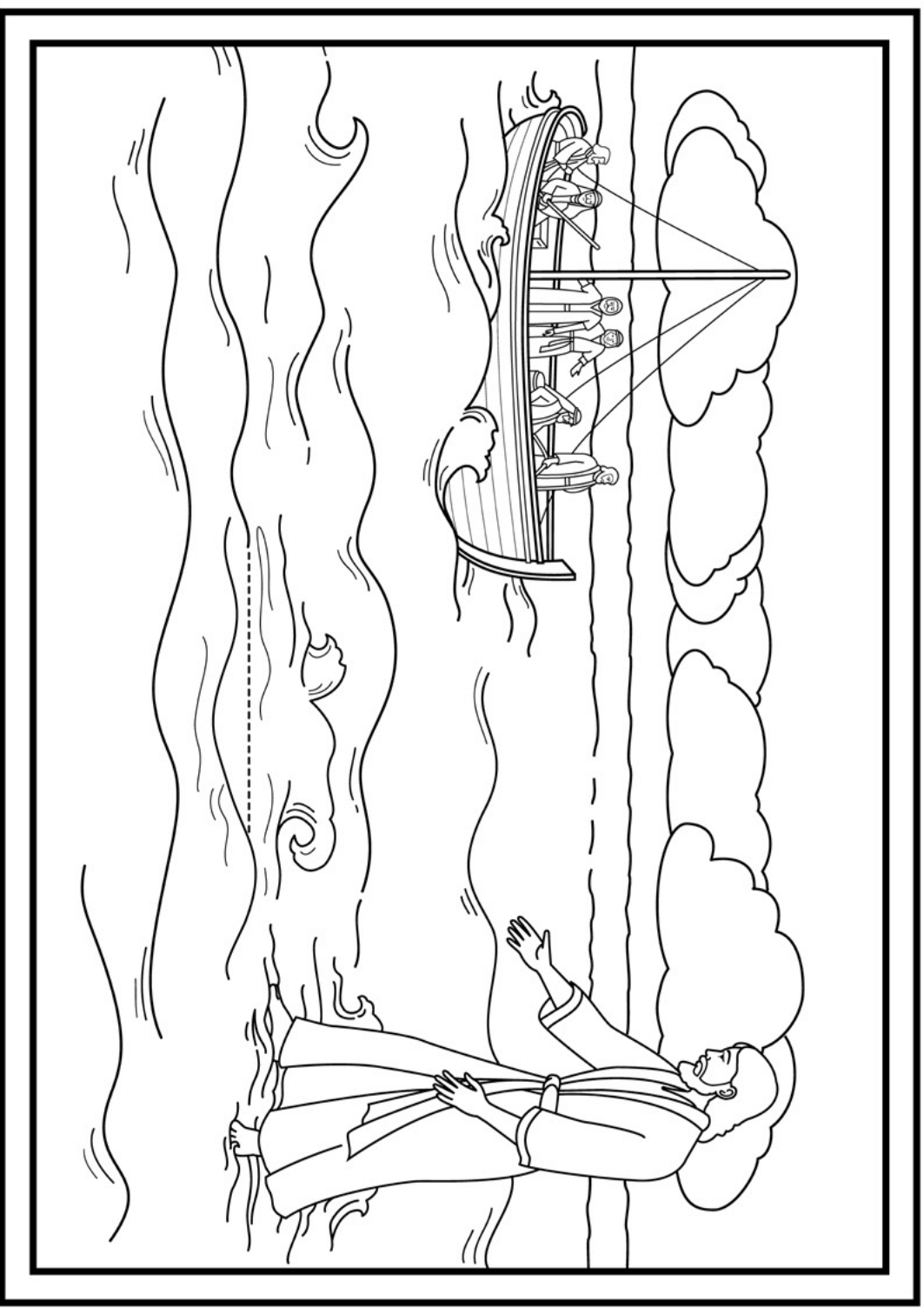



The Transfiguration
by Carl Heinrich Bloch

APRIL 1-14

Matthew 16-17; Mark 9; Luke 9

“Thou Art the Christ”

As you ponder these chapters in the New Testament and listen to the messages during general conference, pay attention to messages that you feel the children in your class need.

RECORD YOUR IMPRESSIONS _____



Invite Sharing

If children in your class listened to or watched general conference, invite them to share something they heard or saw.

Explain that Peter was bearing his testimony of Jesus Christ. Read the verses again. (Or show the video again.) This time ask the children to listen for who told Peter that Jesus Christ was the Son of God.

- Bear your testimony of Jesus Christ, and explain how you received it. Invite the children to seek their own testimonies from Heavenly Father.



Teach the Doctrine

Younger Children

MATTHEW 16:13-17

I can gain a testimony that Jesus Christ is the Son of God.

Consider how you can use Peter’s testimony and Jesus’s response to teach the children what a testimony is and inspire them to seek their own.

MATTHEW 16:15-19

Jesus Christ gives prophets and apostles priesthood keys to lead His Church.

The Savior compared revelation to a rock and priesthood authority to keys. How can you use these comparisons to help the children have faith in those who lead His Church?

Possible Activities

- Ask the children to listen for what Peter said as you read Matthew 16:15-17. (See also “Chapter 32: Peter Testifies of Christ,” *New Testament Stories*, 76-77, or the corresponding video on LDS.org.)

Possible Activities

- Show the children a rock as you read Matthew 16:18 with them. Repeat with them the phrase “upon this rock I will build my church,” adding actions to go along with the words. Explain that the Church is built upon the “rock” of revelation.

- Show the children some keys and ask what we use keys for. Explain that Peter and the other Apostles received priesthood keys from Jesus. These keys “unlock” blessings for us and open the way to heaven. For example, priesthood keys allow us to be baptized and take the sacrament. Give the children paper keys, and have them write some blessings that priesthood keys “unlock.”
- Show a picture of the President of the Church, and bear your testimony that he holds all of the priesthood keys today, just as Peter did.



Jesus gave priesthood keys to Peter.

MATTHEW 17:19-20

My faith can work miracles.

When you read Jesus's promise that faith like a grain of mustard seed can move a mountain, what impressions do you receive about the children you teach?

Possible Activities

- Invite the children to take turns drawing big mountains and small seeds on the board as you read Matthew 17:19–20 with them. Explain that the mountains we have to move are usually things that seem hard for us to do. What are some things that can feel like mountains to us? Use this week's activity page to help the children think about how faith can help them do things that God wants them to do.
- Place a picture of a mountain on one side of the room, and write on it words like *fear*, *doubt*, or *worry*. Ask the children to name some things they can do to gain more faith in Jesus Christ. Let each child who suggests something move the mountain closer to the other side of the room. Read Matthew 17:19–20, and testify of the power of faith in your life.
- Ask the children to sing “Faith,” *Children's Songbook*, 96–97, and then give each child a seed to take home. Invite them to plant the seed and put it somewhere where they can watch it grow to help them remember to have faith in Heavenly Father and Jesus Christ.



Teach the Doctrine

Older Children

MATTHEW 16:13-17

A testimony of Jesus Christ comes through revelation from heaven.

How might Peter's testimony in Matthew 16:13–17 help the children as they build their testimonies?

Possible Activities

- Ask the children what they would say if someone asked them, “Who is Jesus?” Invite the children to read Matthew 16:13–17 to find out how Peter answered that question. How did he gain his testimony of Jesus? What can we do to strengthen our testimonies?
- Help the children compare the way we know spiritual truths with the ways we know other truths. For example, how do we know how tall a person is or what the weather is like? How do we know that Jesus Christ is the Son of God?
- Bear your testimony of Jesus Christ, and challenge the children to gain or strengthen their own testimonies.

MATTHEW 16:15–19**The Church of Jesus Christ is led by those who hold priesthood keys.**

Studying Matthew 16:15–19 can build the children’s faith that The Church of Jesus Christ of Latter-day Saints is a restoration of the same Church that Jesus established while He lived on the earth.

Possible Activities

- Write Matthew 16:19 on the board, leaving out a few words, including the word “keys.” Ask the children to find the missing words.
- Show the video “Priesthood Keys: The Restoration of Priesthood Keys” (LDS.org) or review the information on priesthood keys in *True to the Faith*, 126–27. What are priesthood keys? How are priesthood keys like real keys?
- Help the children list on the board the people who have priesthood keys. (*True to the Faith*, 126–27, has a list that can help them.) Invite someone in your ward who holds these keys to talk to the class about why priesthood keys are important.
- Hide several keys (or pictures of keys) around the room, and invite the children to find them. After each key is found, help the children think of blessings we enjoy because of priesthood keys (for example, eternal families, baptism, and the sacrament).

LUKE 9:28–36**Jesus Christ is the Son of God.**

The Transfiguration of Christ is one of the few times in the scriptures when the voice of God the Father is heard testifying of His Beloved Son. Studying this account with the children can build their faith in Jesus Christ.

Possible Activities

- Invite the children to draw pictures of the Transfiguration of Christ, as found in Matthew 17:1–9. Ask them to explain their pictures to each other. (See also this week’s outline in *Come, Follow Me—For Individuals and Families*.)
- Give the children time to ponder what this story teaches them about Jesus Christ. Invite them to write their thoughts on the board. Invite a few children to share how they know that Jesus Christ is the Son of God.

**Encourage Learning at Home**

Invite the children to ask their parents or other family members how they gained their testimonies of Jesus Christ.

Improving Our Teaching

Use music. Primary songs and hymns can help children of all ages understand and remember gospel truths. Singing can also keep children actively engaged in a learning experience. (See *Teaching in the Savior’s Way*, 22.)

Our faith can work miracles (Matthew 17:19-20).

Color the pictures of things faith can help you do.
Draw something you can do with your faith in the blank space.

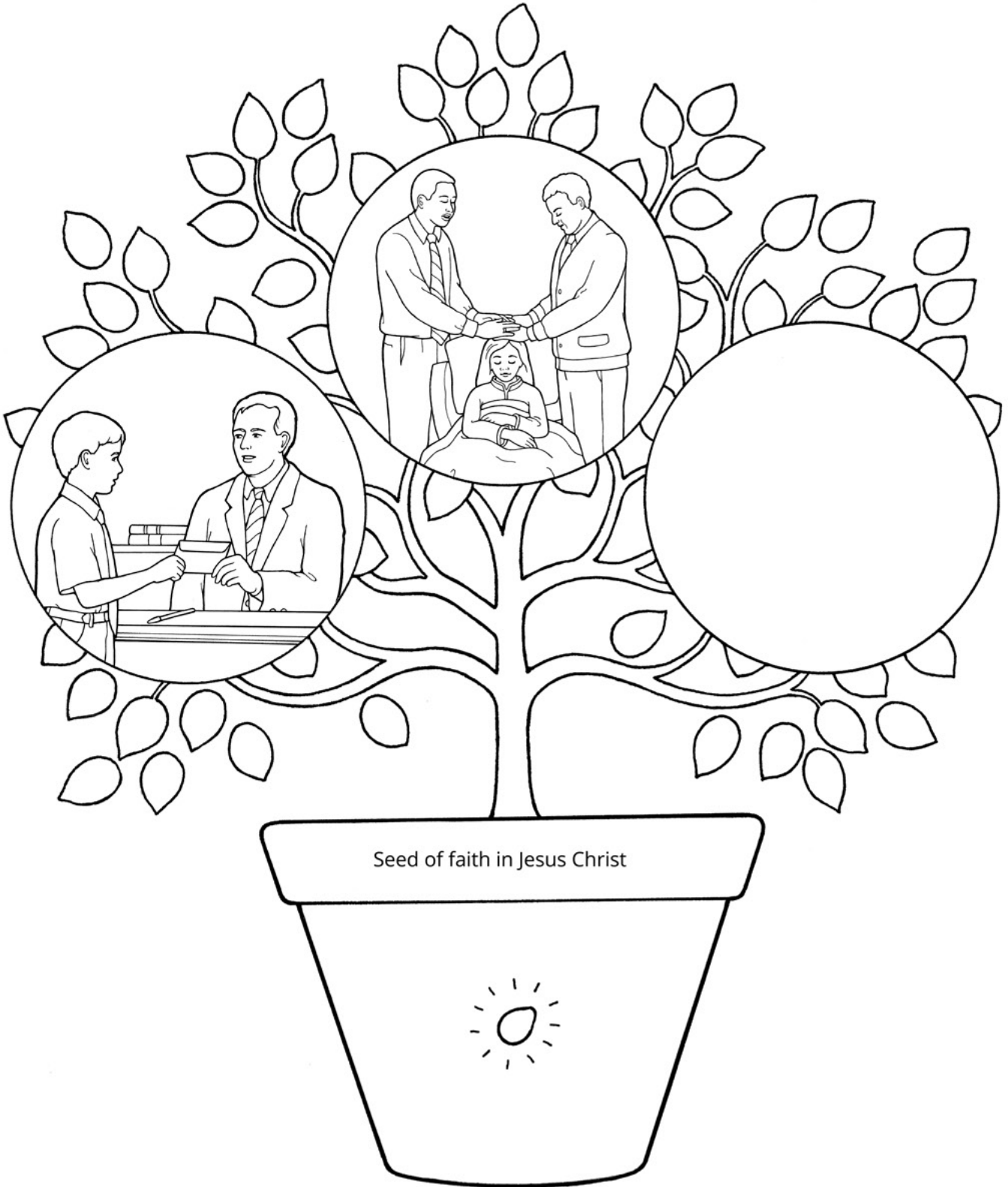



APRIL 15-21

Easter

“O Grave, Where Is Thy Victory?”

Use your time with the children to help them see Easter as a season to rejoice in the Savior and deepen their gratitude for His sacrifice. The ideas in this outline can be adapted to help you teach children of any age.

RECORD YOUR IMPRESSIONS _____



Invite Sharing

To help the children share what they know about Jesus Christ and His Atonement, you might show pictures of the Savior in Gethsemane, on the cross, and after His Resurrection (see the picture in this week's outline in *Come, Follow Me—For Individuals and Families* and *Gospel Art Book*, nos. 56, 57, 58, 59, and 60).



Teach the Doctrine

Younger Children

Jesus Christ is my Savior.

As you read about the Atonement of Jesus Christ, ponder how you can help the children feel how much Jesus loves them.

Possible Activities

- Teach the children that because we all sin, we cannot return to God without a Savior who suffered for our sins. Jesus Christ can save us from our sins if we repent. Hold up a mirror, and let the children take turns looking into it. As each child does, say, “Jesus loves [child’s name], and He can save [child’s name].”
- Show the picture Jesus Praying in Gethsemane (*Gospel Art Book*, no. 56) as you tell the story of Jesus suffering in Gethsemane for the sins of the world (see Matthew 26:36–46; Luke 22:39–44). Explain that because of His suffering, we can be forgiven when we make a wrong choice. You could also use “Chapter 51: Jesus Suffers in the Garden of Gethsemane,” *New Testament Stories*, 129–32, or the corresponding video (LDS.org).
- Sing together “I Feel My Savior’s Love,” *Children’s Songbook*, 74–75. What words in the song describe the Savior’s love? Ask the children how they can help others feel the Savior’s love.

Because Jesus was resurrected, I can live again.

How can you help the children understand that because of Jesus Christ, we and our loved ones will be resurrected someday?

Possible Activities

- Teach the children the story of Easter using pictures of Christ in Gethsemane, on the cross, and after His Resurrection, found in the *Gospel Art Book* (nos. 56, 57, 58, 59, and 60), and the full-page picture in this week's outline in *Come, Follow Me—For Individuals and Families*. Let a few children hold the pictures while you tell the story. Tell the children about a few of the people who saw Jesus after He was resurrected, such as Mary (see John 20:1–18) or Thomas (see John 20:24–29).
- Find out if the children know why we celebrate Easter. Explain that on Easter we celebrate the most important day in history—the day Jesus Christ was resurrected. Ask if any children would like to share what their families do to remember Jesus Christ's Resurrection.
- Explain that *resurrected* means to live again after we die. Bear your testimony that because of Jesus Christ, we will be resurrected—we will live again after we die, and we will never die again.
- Use a glove to teach the children that we all have a body (represented by the glove) and a spirit (represented by a hand). When we die, our spirits continue to live, but our bodies do not. When we are resurrected, our spirits and bodies come together again. Let the children take turns putting the glove on and taking it off.
- Sing together an Easter song, such as “Did Jesus Really Live Again?” or “Jesus Has Risen,” *Children's Songbook*, 64, 70, and show the children pictures of Jesus after He was resurrected (*Gospel Art Book*, nos. 59, 60, 61).
- Display a picture of someone you know who has died. Share your testimony that he or she will be resurrected because of the Atonement and Resurrection of Jesus Christ.
- Watch together the videos “Jesus Is Resurrected” or “The Risen Lord Appears to the Apostles” (LDS.org). Additional Easter messages can be found on mormon.org/easter.



He is Risen, by Greg Olsen



Teach the Doctrine Older Children

Jesus suffered for me in Gethsemane and on the cross.

As you study the Savior's Atonement, ponder how you can help the children learn and remember that Christ suffered in Gethsemane and on the cross for their sins, sicknesses, and sorrows.

Possible Activities

- Read with the children Luke 22:39–44 and selected verses from Matthew 27:29–50. Invite them to look for words that help them understand what the Savior experienced in Gethsemane and on the cross.
- Help the children memorize the third article of faith. Bear your testimony that Jesus Christ has the power to save us from sin and from death.

- Help the children prepare short talks about the Atonement of Jesus Christ that they can share with others. Encourage them to include a scripture and their testimonies in their talks. If they need additional help, they could read “Atonement of Jesus Christ” in *True to the Faith*, (14–21).

Because Jesus died and was resurrected, I will live again.

The children you teach will someday experience the death of a loved one if they haven't already. Help them know that because Jesus Christ was resurrected we will all be resurrected.

Possible Activities

- Display *Gospel Art Book*, nos. 57, 58, and 59, and ask the children to match the pictures with the following passages: Matthew 27:29–38, 59–60; John 20:10–18.
- Invite children to individually read “Resurrection” in the Bible Dictionary and write test questions they

could ask about what they read. Give the children time to ask each other their questions and find the answers together.

- Help the children look in the topical index of the *Children's Songbook* to find a song they would like to learn about Jesus Christ or the Resurrection. Sing the song together a few times. Ask the children what they learn from this song.
- Before class, invite a few children to come prepared to share their testimonies about the Savior's Atonement and Resurrection. Invite the children to write down their testimonies to share at home.



Encourage Learning at Home

To help the children share what they learned with their families, encourage them to sing a song about Jesus Christ at home this week.

Improving Our Teaching

Children benefit from repetition. Don't be afraid to repeat activities multiple times, especially with younger children. Repetition will help the children remember what you teach.

Because Jesus was resurrected, I will live again (John 20:11-29).

Color and cut out the objects below. Put the piece with Jesus Christ on top of the other piece and attach them in the center. Rotate the circle as you discuss how Mary Magdalene (John 20:11-18), the disciples (John 20:19-23), and Thomas (John 20:24-29) saw Jesus after He was resurrected.

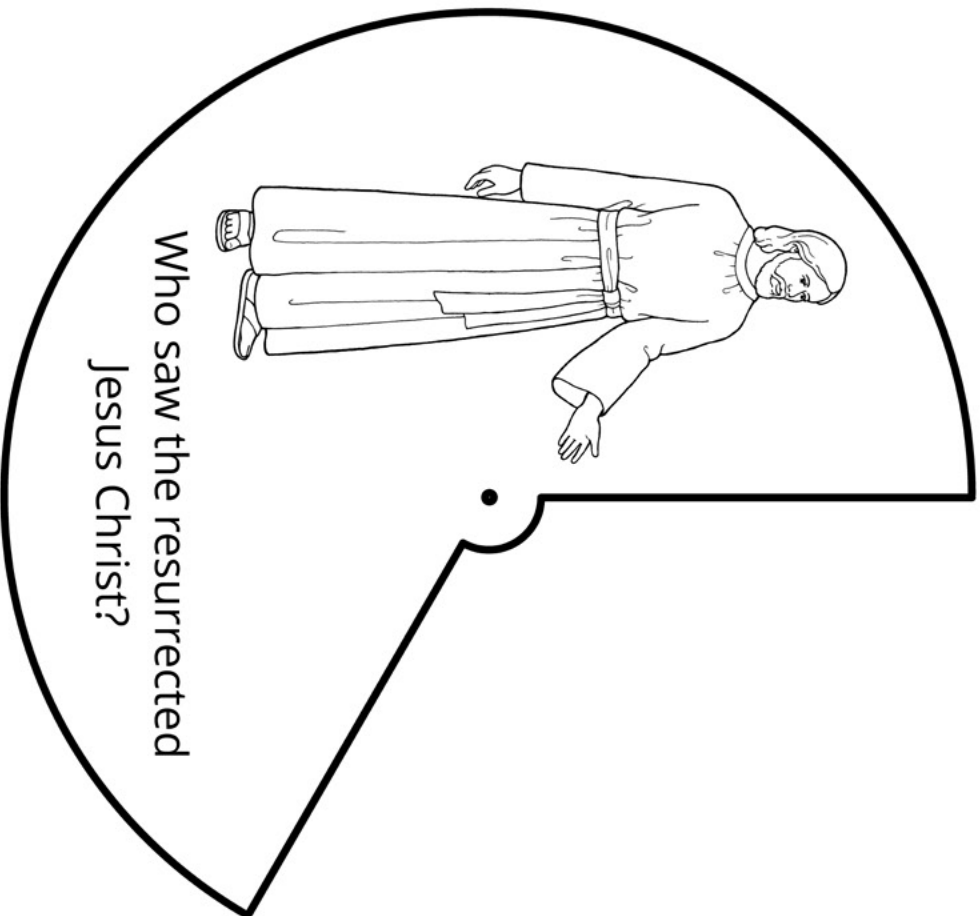



The Good Samaritan, by Dan Burr

APRIL 22-28

Matthew 18; Luke 10

“What Shall I Do to Inherit Eternal Life?”

What truths in Matthew 18 and Luke 10 do the children need to learn? Listen for promptings from the Holy Ghost as you read these chapters. *Come, Follow Me—For Individuals and Families* can help you understand the doctrine, and this outline can give you ideas for how to teach these truths.

RECORD YOUR IMPRESSIONS _____



Invite Sharing

Ask the children to share how they celebrated Jesus Christ’s Atonement for Easter.



Teach the Doctrine Younger Children

MATTHEW 18:21-35

I should always forgive others.

As you read Matthew 18:21–35, consider your own experiences with forgiveness and what the children need to know about this principle.

Possible Activities

- Read Matthew 18:21, and invite the children to say “I forgive you” seven times. Ask, “Is forgiving seven

times enough?” Read verse 22 and explain that Jesus wants us to choose to forgive always.

- Tell the parable of the unmerciful servant (see Matthew 18:23–35). If necessary, explain that when someone does something unkind to us, we will probably feel angry or sad at first. But forgiveness means we can feel peace again. (You may feel prompted to help the children understand that if someone is hurting them, they should tell their parents or another trusted adult.)
- Write *I forgive you* on the board, and tell the children that these words can help turn sad moments into happy ones. Draw a sad face on the board, and share some examples of children forgiving one another. After each example, invite a child to change the sad face to a happy one.
- Sing with the children “Help Me, Dear Father,” *Children’s Songbook*, 99. Ask them to stand up when they hear the word *help*. Share your testimony that Heavenly Father will help us forgive others.

LUKE 10:25–37**Jesus taught me to see all people as my neighbors and love them.**

The parable of the good Samaritan is a memorable story that can show children who our neighbors are. Think of ways you can inspire the children to “go, and do . . . likewise” (Luke 10:37).

Possible Activities

- Ask each child, “Who is your neighbor?” Explain that Jesus taught that anyone who needs our help is also our neighbor, even if he or she doesn’t live nearby, and we should treat that person with love.
- Read Luke 10:25–37 as the children act out the parable of the good Samaritan, taking turns playing different roles. After each performance, ask them to share how they can be like the good Samaritan.
- Write a few examples of situations where someone would need help, and hide the papers around the room. Ask the children to find the papers and explain how they could show kindness to the person in that situation.
- Sing with the children “Jesus Said Love Everyone” and “Kindness Begins with Me,” *Children’s Songbook*, 61, 145. Divide the children into pairs, and invite each pair to think of a few ways they can show love or kindness to others. Ask each pair to share their thoughts with the class.
- Invite the children to write down ways they can show love for others on small slips of paper. Make a paper chain from these slips and invite the children to hang the paper chain in their home, where it can remind them to be kind.

**Teach the Doctrine**
Older Children**MATTHEW 18:21–35****Heavenly Father will forgive me as I forgive others.**

As children get older, forgiving may get harder. The parable of the unmerciful servant can be a memorable way to teach them that Heavenly Father wants us to forgive everyone.

Possible Activities

- Read Matthew 18:23–35 with the children; explain that the lord or king represents Heavenly Father, the servant represents us, and the fellow servant represents those who offend us. Ask the children, “When have you found it difficult to forgive someone? How did you let go of those hurt feelings? When have you needed to be forgiven for a wrong choice?”
- Show the video “Forgive Every One Their Trespasses: The Parable of the Unmerciful Servant” (LDS.org) to help the children visualize this parable.
- Write on the board the multiplication problem 70×7 , and help the children solve it. Ask someone to read Matthew 18:21–22, and explain that Jesus used this number to teach us that we should always forgive.
- Give everyone a piece of paper, and invite the children to draw a picture of a child being unkind to another child. Then ask them to trade their papers with their neighbor and draw on the back of the new paper a way they can show forgiveness to others.
- Ask the children to help you think of a few situations where someone might need to forgive another person. Invite the children to act out how they would show forgiveness in those situations.

- Sing with the children “Help Me, Dear Father,” *Children’s Songbook*, 99. Help the children understand each line of the song and what it teaches us about forgiving others.

LUKE 10:30–37

I can love and serve others, especially those in need.

Ponder times in your own life when someone has been “a good Samaritan” to you. How can you inspire children to be “good Samaritans” to others?

Possible Activities

- Assign each child part of the parable of the good Samaritan to draw. Invite them to put their pictures in order and use them to tell the story.
- Explain to the children that the Jews disliked the Samaritans so much that when they traveled from Jerusalem to Galilee, they would go around Samaria

to avoid interacting with any Samaritans (see Bible Maps, no. 1, “Physical Map of the Holy Land”). Why would Jesus use a Samaritan as an example of kindness in this parable? What does this story teach us about helping others in need? (See also Mosiah 4:16–22.)

- Ask the children to share an experience when someone was like the good Samaritan toward them.
- Challenge the children to set a goal to be like the good Samaritan this week. For example, do they know someone who is sick or lonely? or someone who does not attend church regularly? Ask the children how they could help that person.



Encourage Learning at Home

Invite the children to share with their family their goal to be like the good Samaritan this week.

Improving Our Teaching

Teach children to record impressions. If children can learn the habit of recording impressions, it will help them recognize and follow the Spirit. Children can record impressions by marking scriptures, drawing pictures, or making simple journal entries.

I show my love for Heavenly Father when I show love for others (Luke 10:25-37).

Color and cut out the viewfinder and the picture strip. Cut two slits along the dotted lines of the viewfinder. Slide the picture strip through the viewfinder as you tell the story of the good Samaritan.

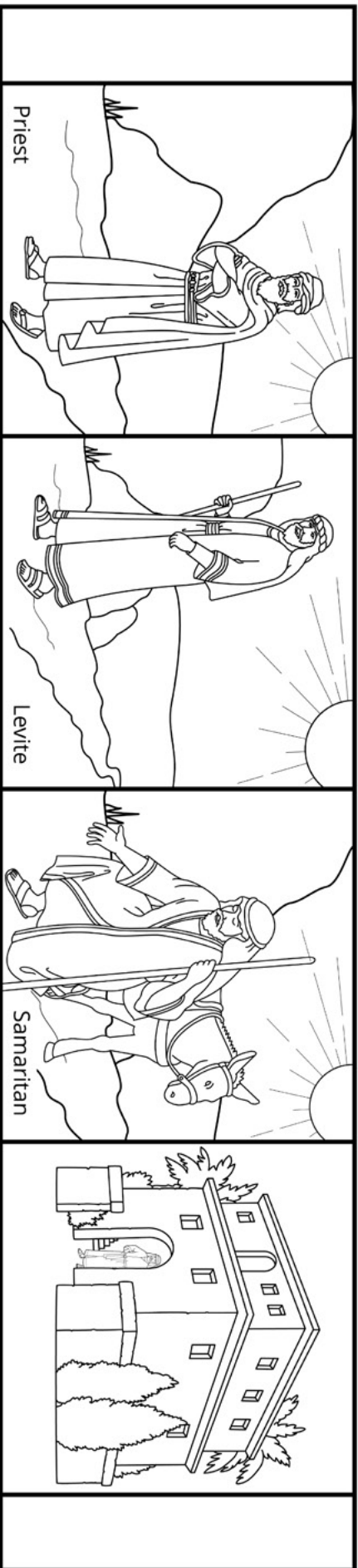
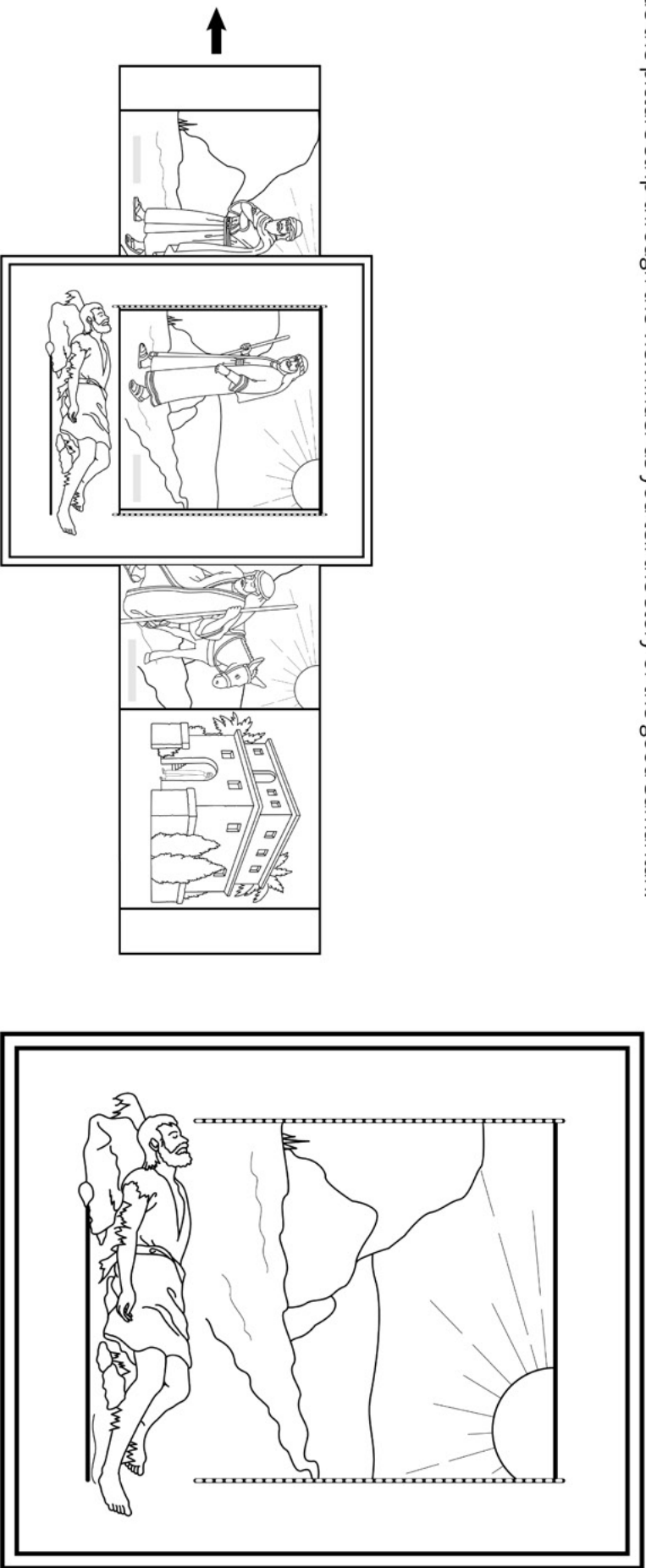



He That Is without Sin,
by Liz Lemon Swindle

APRIL 29–MAY 5

John 7–10

“I Am the Good Shepherd”

As you read John 7–10, think of the children you teach. Many of the ideas for older children in this outline can also be adapted for younger children, or vice versa.

RECORD YOUR IMPRESSIONS _____



Invite Sharing

Ask the children to share something they did last week to be like the good Samaritan.



Teach the Doctrine

Younger Children

JOHN 7:14–17

Keeping the commandments will help me know they are true.

Jesus taught that we can gain a testimony of the truths He shared as we live them. How can you use this account to teach the children that the peace we feel when we obey the commandments helps us know they are true?

Possible Activities

- Summarize John 7:17 in words the children will understand. Help them know that obeying the commandments helps us feel closer to Jesus Christ, perhaps by singing together “Keep the Commandments” or “Choose the Right Way,” *Children’s Songbook*, 146–47, 160–61. Ask the children to listen for how we will be blessed when we keep the commandments.
- Share an experience when you learned a commandment was from God because you lived it, such as paying tithing or forgiving someone who was unkind. Invite the children to think of an experience they had when they obeyed a commandment. Ask, “How did you feel after you obeyed?”
- Select some of the commandments and draw two sets of simple pictures that represent each commandment. Lay all of the pictures face down on the ground and invite the children to take turns matching the commandments together. Testify of the importance of commandments and how following them has strengthened your testimony.

JOHN 8:29**Jesus obeyed His Father.**

Jesus Christ always did things that pleased His Father in Heaven. How can you help the children find ways to follow His example?

Possible Activities

- Help the children repeat what Jesus said about Heavenly Father in John 8:29: “I do always those things that please him.” Ask them to share things Jesus did that made Heavenly Father happy. Show them some pictures from the *Gospel Art Book* to give them ideas.
- Ask the children what makes them happy. Then ask what they could do this week to make a family member or friend happy. Invite the children to draw pictures of themselves doing those activities to take home and remind them.
- Invite a parent of one of the children to share an experience when the child did something that made the parent happy. Let the child share how he or she felt.

JOHN 10:1–18**Jesus knows me and loves me.**

The parable of the good shepherd can help the children understand that Jesus loves them and knows who they are.

Possible Activities

- Ask the children to draw a picture that represents something in the parable of the good shepherd, like sheep, a robber, or a wolf. Read John 10:1–18 to the children, and ask them to hold up their pictures when they hear you read about what they drew. Explain that just like the “good shepherd” guides and loves his flock, Jesus loves us and guides us all back to Him. Dress up one of the children like a shepherd, and let the children share how Jesus is like a shepherd to us.

- Show the picture of Jesus and the lambs in this week’s outline in *Come Follow Me—For Individuals and Families*. How do we know Jesus loves the lambs? How can we tell that the lambs love Jesus?
- Help the children complete this week’s activity page.



Teach the Doctrine

Older Children

JOHN 7:14–17**Keeping the commandments will help me know they are true.**

You and the children you teach may have had experiences living gospel truths and learning that they are true. How can you build on those experiences as you teach?

Possible Activities

- Write each verse of John 7:14–17 on different pieces of paper and display them in random order. Ask the children to put them in the correct order and check John 7:14–17 to see if they are right. Invite the children to split into pairs and share their understanding of each verse with their partner. How has obedience to God’s commandments helped them know the commandments are true?
- Share examples from the scriptures showing how people were blessed for living gospel truths, such as Daniel (see Daniel 6) or Nephi (see 1 Nephi 3–4).
- A few days before class, invite one of the children to write about a time when he or she gained a testimony of a commandment by living it. During class, ask the child to share what he or she wrote.

JOHN 8:31–36**The truth can make us free.**

As the children get older, they will encounter people who believe that living the gospel is restrictive. How can you use John 8:31–36 to counter such claims?

Possible Activities

- Invite the children to read John 8:31–36 and share what they think it means to be a servant of sin. How do the teachings of Jesus help us be free?
- Ask a child to help you lightly wrap a rope, scarf, or necktie around your wrists to demonstrate how we become bound to sin when we commit it over and over again without repenting.
- Show a lock to represent sin and a key to represent how truths of the gospel can make us free. For example, knowing about the Savior's Atonement can give us freedom to repent and be forgiven of our sins. Or knowing about the Word of Wisdom can give us freedom to avoid addictions.



Jesus taught, "The truth shall make you free" (John 8:32).

JOHN 10:1-18

Jesus is like a shepherd for us.

As you study the parable of the good shepherd, look for truths it teaches about our relationship with the Savior. How will knowing these truths bless the children?

Possible Activities

- Write *good shepherd* and *hireling* on the board. Explain that a hireling is someone who is hired to do a job for money. Ask the children to list differences they find in John 10:1–18 between a good shepherd and a hireling. Why would you want to follow the good shepherd rather than the hireling?
- Draw or show a picture of a door. Read together John 10:7–9, and ask the children how Jesus is like a door. According to verse 9, what blessings come to those who "enter in" the door? How do we enter the door that Jesus Christ provides us?



Encourage Learning at Home

Help the children think of a commandment they can obey more fully. Ask them to try to obey that commandment during the coming week.

Improving Our Teaching

Ask inspired questions. Ask questions that invite the children you teach to go beyond reporting facts. Instead, encourage them to share their testimonies of gospel truths. For example, if you are discussing the commandments, you could ask the children to share how obeying the commandments has blessed them.

Jesus knows me and loves me (John 10:1-18).

Color and cut out the figures. Color both sides of Jesus's arms and bend them so that He can hold the sheep.

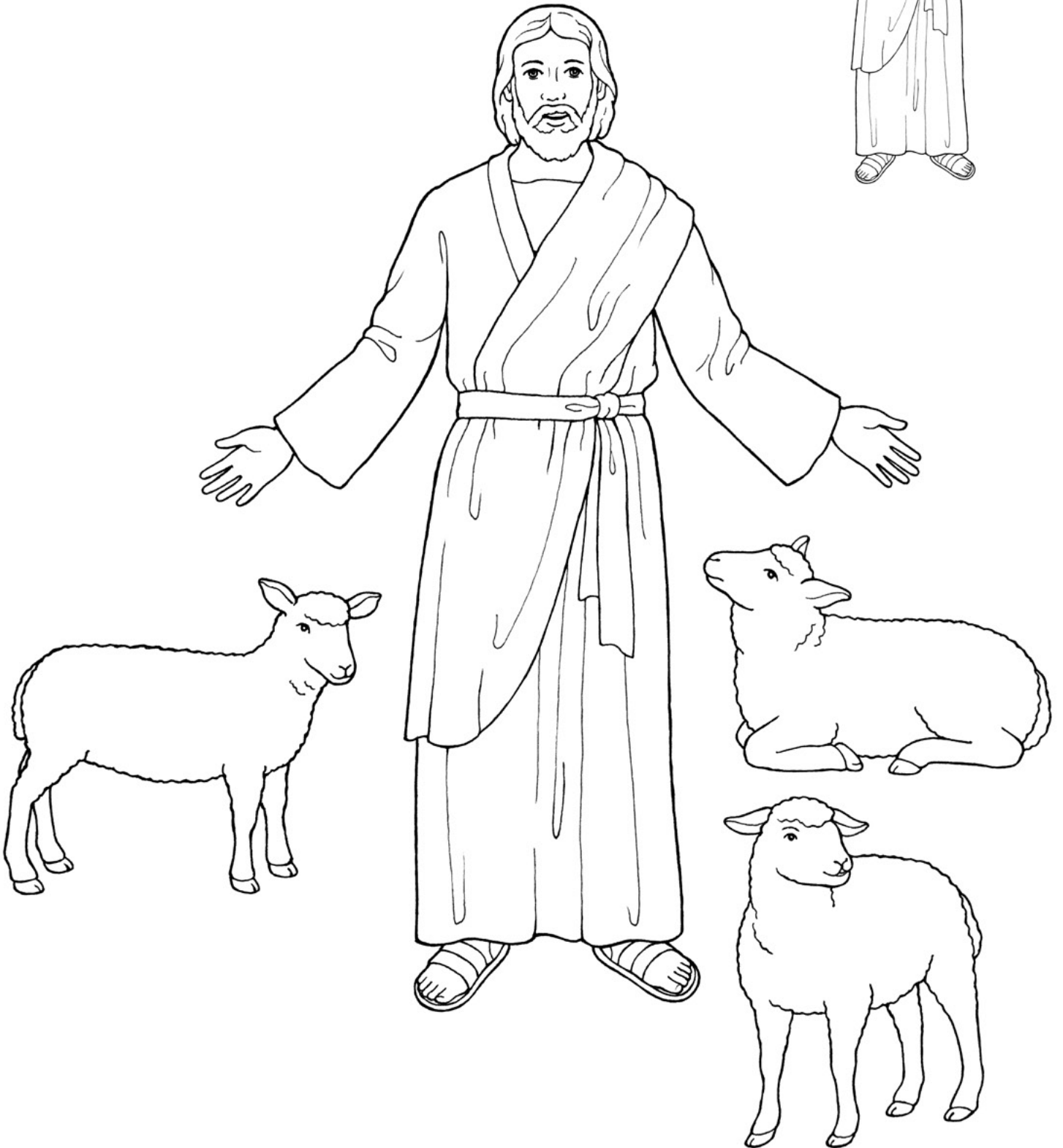



The Prodigal Son, by Liz Lemon Swindle

MAY 6-12

Luke 12-17; John 11

“Rejoice with Me; for I Have Found My Sheep Which Was Lost”

Prayerfully read Luke 12-17 and John 11, seeking for how you can help the children you teach understand the truths in these chapters and feel Heavenly Father’s love.

RECORD YOUR IMPRESSIONS _____



Invite Sharing

Remind the children of some of the parables and stories found in Luke 12-17 and John 11, and invite them to choose one and draw a picture of it.



Teach the Doctrine Younger Children

LUKE 15

Heavenly Father wants all of His children to return to Him.

There may be some children in your class who don’t attend Primary regularly. How can you inspire the children you teach to reach out to them in love?

Possible Activities

- Give one child a coin, another child a picture of a sheep, and another child a picture of the prodigal son (LDS.org). Tell the three parables found

in Luke 15 and invite the children to hold up their coin or picture when you mention it. You could invite the children to retell the parables to each other in their own words.

- Ask the children to share a time when they lost something. Explain that people can become lost spiritually when they don’t feel God’s love or when they turn away from Him. Testify that these parables teach that God wants us to help people who are lost come back to Him.
- Invite the children to think of other children who don’t come to Primary. Help them write notes inviting these children to attend Primary or a Primary activity. How else can we help these children feel Heavenly Father’s love for them?

LUKE 17:11-19

I can show my love for Heavenly Father by being grateful for my blessings.

How might the story of the ten lepers encourage the children to be thankful?

Possible Activities

- Tell the story of the ten lepers who were healed by Jesus. Show the picture found in this week's outline in *Come, Follow Me—For Individuals and Families* and invite the children to count to ten on their fingers. Then ask them to put down nine fingers to show the one leper who thanked Jesus. When have the children expressed their gratitude to a friend or loved one?
- Invite each child to act out something he or she is grateful for, and have the rest of the children guess what it is. Ask the children to share ways we can show Heavenly Father that we are thankful for our blessings.

JOHN 11:1–46

We believe that Jesus is the Son of God.

Martha, who was Lazarus's sister, told Jesus: "I believe that thou art the Christ, the Son of God" (John 11:27). The story of Mary, Martha, and Lazarus can strengthen the children's testimonies of Jesus Christ.

Possible Activities

- Summarize the story of Jesus raising Lazarus from the dead (see also "Chapter 43: Jesus Brings Lazarus Back to Life," *New Testament Stories*, 107–9, or the corresponding video on LDS.org) and show a dead branch and a living plant. Bear your testimony that because of the power of Jesus Christ, people who are dead will be resurrected and live forever.
- Help the children memorize the phrase that Jesus said to Martha: "I am the resurrection, and the life" (John 11:25). Explain that because of the Savior's Resurrection, we will once again see our loved ones who have died.



Teach the Doctrine

Older Children

LUKE 15

I can help Jesus find His lost sheep.

The children might not be aware that there are others in the class who do not come to Primary. How can you inspire them to reach out to these children?

Possible Activities

- Assign each child to read silently either the parable of the lost sheep or the parable of the lost coin, found in Luke 15:1–10, and share what they learned.
- Write these names on the board: *father, older son, and younger son*. Show the video "The Prodigal Son" (LDS.org) and pause it occasionally so the children can write on the board some of the feelings of the people listed.
- Ask a child to leave the room while the other children hide a coin or paper sheep. Have the child return and look for the coin or sheep. Remind the children that people can become lost to the blessings of the gospel. Invite them to suggest ways they can reach out to such people. Sing together with the children "Dear to the Heart of the Shepherd" (*Hymns*, no. 221) and testify of the joy that comes when people return to God.
- Explain that Jesus used the lost sheep, the lost coin, and the prodigal son to represent people who are "lost" because they do not have the blessings of the gospel. Invite the children to think of people they know who don't come to church. What can they do to help these people feel Heavenly Father's love for them?



Lost Sheep, by Liz Lemon Swindle

LUKE 17:11-19

I can show my love for Heavenly Father by being grateful for my blessings.

The story of the ten lepers might be a good way to inspire the children to express gratitude to Heavenly Father for their blessings.

Possible Activities

- Read together the account of the ten lepers. How was the leper who gave thanks blessed for his gratitude? Why is it important to thank God for our blessings?
- Invite the children to list things they are grateful for that start with each letter of their name.
- Ask the children to write thank-you notes to Heavenly Father for the blessings He gives them. They could hang the notes by their beds to remind them to express gratitude when they pray.

JOHN 11:1-46

We believe that Jesus is the Son of God.

How can you use the story of Mary, Martha, and Lazarus to help the children know, as Martha did, that Jesus is “the Christ, the Son of God”? (John 11:27).

Possible Activities

- Write on the board some statements spoken by people in John 11. Invite the children to guess who said each statement, and ask them to search John 11 to check their guesses. How would they feel if they were Jesus, Martha, Mary, or Lazarus? How can believing in Jesus help us when we are sad or scared?
- Read Martha’s testimony, found in John 11:20–27. Ask the children to look for words and phrases that show that Martha had faith. What can we do to have faith when it is hard?
- Help the children memorize John 11:25. Explain that everyone will be resurrected, but only the righteous will receive eternal life and live with Heavenly Father and Jesus Christ again.



Encourage Learning at Home

Give the children some paper or a small notebook they can use to write or draw things they are grateful for throughout the week.

Improving Our Teaching

Repetition is a key to learning. Children benefit from hearing a gospel principle or doing an activity more than once. Try repeating activities in a variety of ways.

I can help Jesus find and bring back His lost sheep (Luke 15).

Help the shepherd find his lost sheep, the woman find her lost coin, and the father find his lost son.

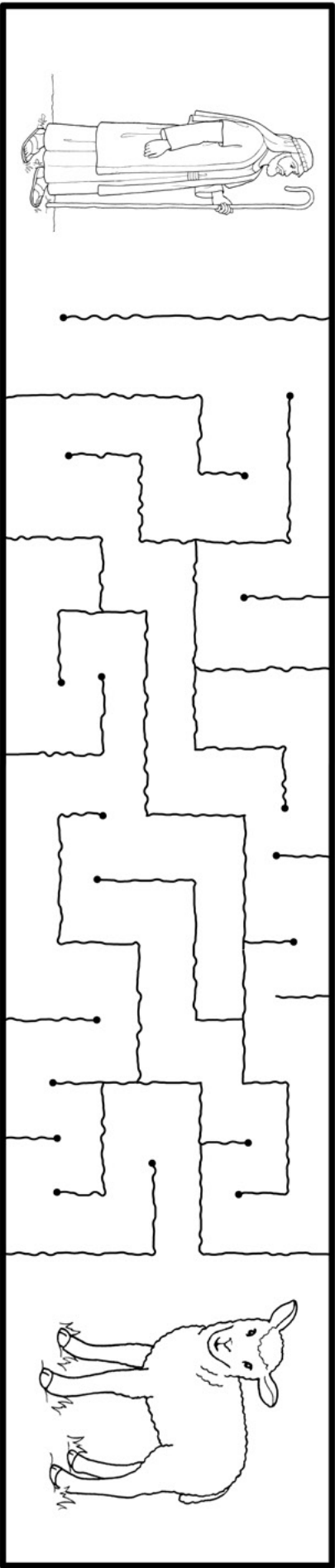

A maze puzzle with a shepherd on the left and a lost sheep on the right. The shepherd is holding a staff and a crook. The sheep is a small lamb. The maze is a complex network of paths and dead ends.

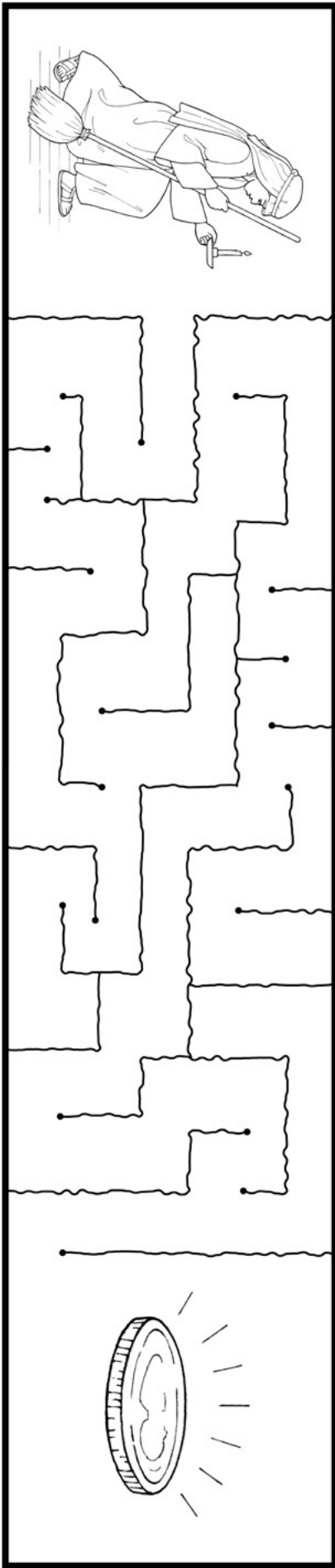

A maze puzzle with a woman on the left and a lost coin on the right. The woman is holding a broom and a candle. The coin is a large, round object with a heart shape on it. The maze is a complex network of paths and dead ends.

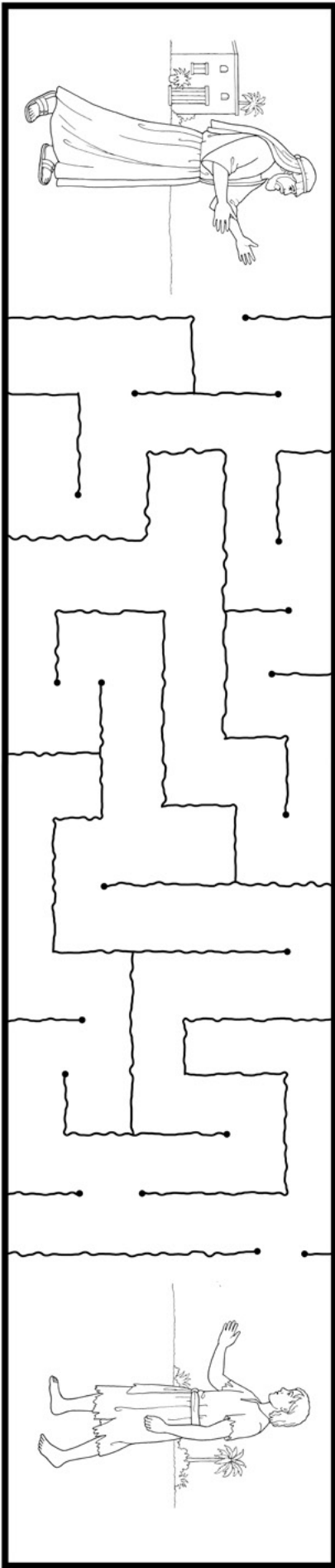

A maze puzzle with a father on the left and a lost son on the right. The father is holding a staff and a crook. The son is a young boy. The maze is a complex network of paths and dead ends.



MAY 13-19

Matthew 19–20; Mark 10; Luke 18

“What Lack I Yet?”

Read Matthew 19–20; Mark 10; and Luke 18, keeping the children you teach in mind.

Record any promptings you receive. Your preparation will help you teach the children what they need to know from these chapters.

RECORD YOUR IMPRESSIONS _____



Invite Sharing

Invite the children to tell the class something they love about their family. You might even ask the children’s parents to provide pictures of their families for their children to share with the class.



Teach the Doctrine

Younger Children

MARK 10:6–8

Heavenly Father wants us to marry in the temple and have eternal families.

How can the children you teach benefit from learning about the doctrine of eternal marriage? It may be helpful to refer to “The Family: A Proclamation to the World” (*Ensign* or *Liahona*, Nov. 2010, 129).

Possible Activities

- Read Mark 10:6–8 to the children, and display a picture of a married couple. Ask the children to point to the man and the woman when they hear you read the words *male* and *female*. Explain that Heavenly Father intends for a man and woman to marry each other (see Genesis 1:27–28).
- Display pictures of a family and a temple. Explain that Heavenly Father wants us to be sealed to our families in the temple so we can be with them forever. Be sensitive to children whose parents are not yet sealed.
- Sing “A Happy Family” (*Children’s Songbook*, 198). Invite the children to point to themselves whenever they sing “I,” “me,” “us,” and “we.” This activity could be repeated several times. Invite the children to share fun things they have done with their families. Why are they thankful for their families?
- Sing a song about the temple or families, such as “I Love to See the Temple” or “Families Can Be Together Forever” (*Children’s Songbook*, 95, 188). Let the children hold pictures of temples or families,

and invite them to hold up their pictures when they sing “temple” or “family.” Why is it important to get married in the temple?



Eternal marriage is part of God's plan.

MARK 10:13–16

Jesus wants little children to come to Him so He can bless them.

This account provides an opportunity to help children feel how much Jesus loves them.

Possible Activities

- In your own words, share the account in Mark 10:13–16. You might also show the video “Suffer the Little Children to Come unto Me” (LDS.org). When have the children felt Jesus’s love for them? Bear your testimony to the children that Jesus loves them and wants to bless them.
- Display the picture *Christ and the Children* (*Gospel Art Book*, no. 47). Explain that if we want to be like the children sitting next to Jesus then we can follow His commandments and love Him and other people. What can the children do to be like the children sitting next to Jesus?
- Let the children draw pictures of themselves being blessed by Jesus (see Mark 10:16).

MARK 10:17–22

If we obey the commandments, we can receive eternal life.

Jesus taught the rich young man that to gain eternal life—a life like Heavenly Father has—he should obey the commandments.

Possible Activities

- Read the story of the rich young man in Mark 10:17–22 with the children. (See also “Chapter 42: The Rich Young Man,” *New Testament Stories*, 105–6, or the corresponding video on LDS.org.) Ask them to listen for what Jesus told the young man to do and how the young man responded.
- Tell one or more stories about children who ask for advice or direction from their parents but don’t follow or obey. What are some things Heavenly Father asks us to do? How do we feel when we obey His commandments?
- Share experiences when you received personal promptings to do something to be better.



Teach the Doctrine Older Children

MARK 10:6–8

Heavenly Father wants us to marry in the temple and have eternal families.

The things Jesus taught about marriage can help the children when they face contradictory messages in the world.

Possible Activities

- Ask one of the children to read Mark 10:6–8 out loud. Explain that *cleave* means to “stick to” or “hold tight to” something. Why is it important that husbands and wives join together, love each other, and work as partners?

- Share the following statement from “The Family: A Proclamation to the World,” and help the children understand what it means: “Gender is an essential characteristic of individual premortal, mortal, and eternal identity and purpose.”
- Ask the children to help you think of answers to questions like “Why are families important in the Church?” or “Why is it important for you to get married in the temple?” Sing together “Families Can Be Together Forever,” *Children’s Songbook*, 188. Share your testimony of eternal marriage and family with the children. Invite them to share their testimonies as well.
- Invite each of the children to read a scripture from this list: Mark 10:6–8; 1 Corinthians 11:11; D&C 42:22; 131:1–4; and Moses 3:18, 21–24. What do these scriptures teach about marriage?

MARK 10:17–22

Jesus can help me know what I need to do to progress.

The rich young man sought Jesus and received specific instruction that was meant especially for him. How can you inspire the children to seek similar guidance in their own lives?

Possible Activities

- Ask the children to find a verse in Mark 10:17–22 that describes the picture in this week’s outline in *Come, Follow Me—For Individuals and Families*. Explain that the counsel Jesus gave to the young man was personal, and we can all receive personal direction from the Lord through the Spirit.
- Read together Mark 10:17–22. Invite the children to write on the board the commandments that the Savior told the rich young man to obey (see verse 19). What else did he have to do? (see verse 21). Encourage the children to think about things they might need to begin doing or stop doing to better follow Jesus. What are some ways we can find out what Jesus wants us to do?



Encourage Learning at Home

Invite the children to tell their families why they are grateful for them, perhaps by writing a note to give to their parents or by sharing their testimony of families during family home evening.

Improving Our Teaching

Pay attention to the children. How are the children in your class responding to learning activities? If they don’t seem engaged, it may be time to try another activity or to take a short, reverent walk. On the other hand, if you notice that the children are engaged and learning from a certain portion of the lesson, don’t feel pressure to move on just to make sure that you cover all the lesson material.

Jesus wants little children to come unto Him so that He can bless them (Mark 10:13-16).

Draw faces on the children and color the picture.

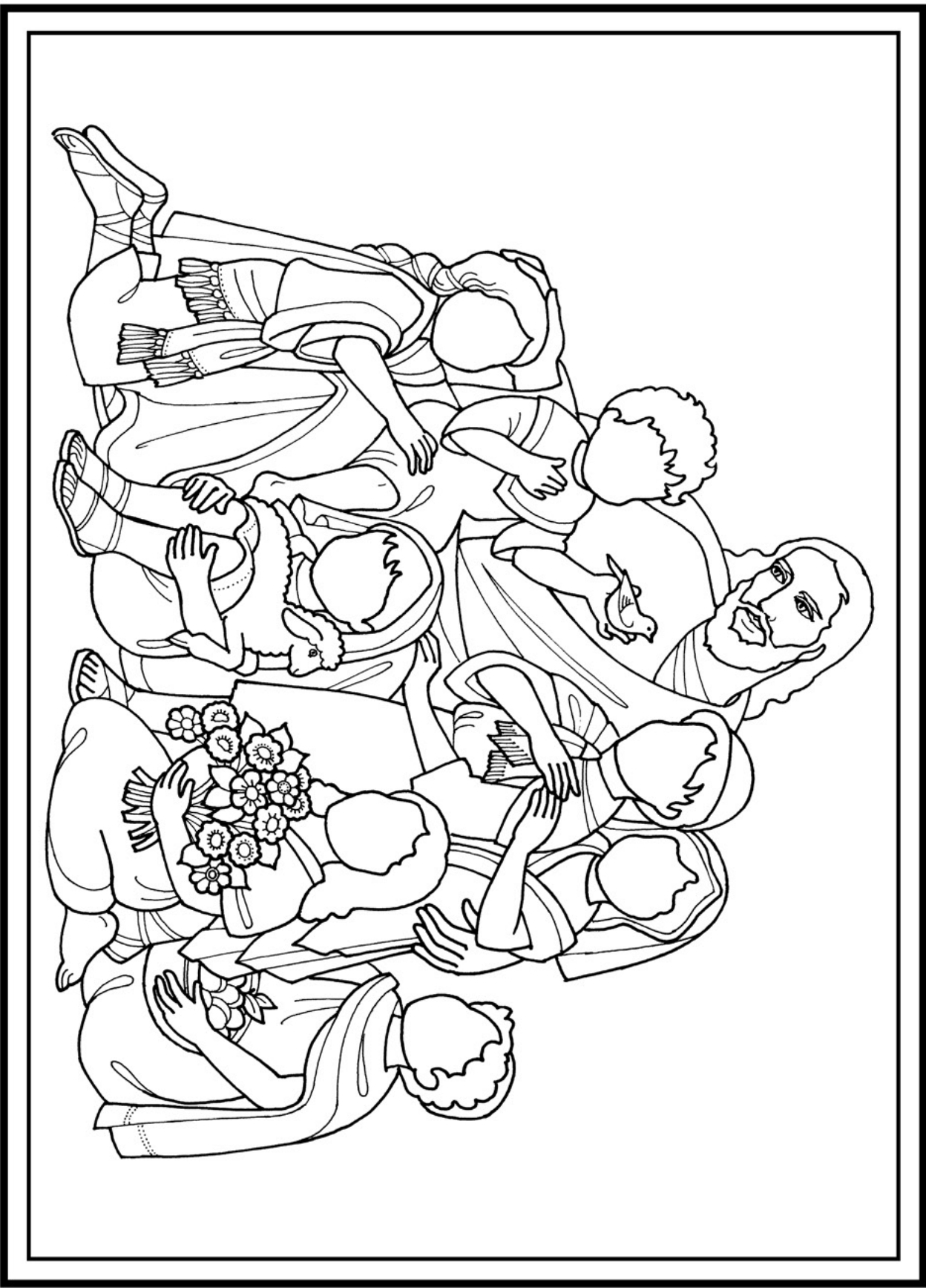



Zacchaeus in the Sycamore Tree,
by James Tissot

MAY 20-26

Matthew 21-23; Mark 11; Luke 19-20; John 12

“Behold, Thy King Cometh”

As you read Matthew 21-23; Mark 11; Luke 19-20; and John 12, pay attention to impressions you receive from the Holy Ghost. Refer to “Meeting the Needs of Younger Children” at the beginning of this manual for things to keep in mind as you teach these principles.

RECORD YOUR IMPRESSIONS _____



Invite Sharing

Show the picture from this week’s outline in *Come Follow Me—For Individuals and Families*, and invite the children to share what they know about what is happening in the picture.



Teach the Doctrine Younger Children

LUKE 19:1-10

Heavenly Father and Jesus know me by name.

As you read about the Savior’s interaction with Zacchaeus, what messages do you find that may bless the children you teach?

Possible Activities

- Show the picture Zacchaeus in the Sycamore Tree (LDS.org). Help the children identify Zacchaeus and say his name. Create actions for the children to do as you tell the story of Zacchaeus and Jesus—for example, standing on their toes to see over a crowd or pretending to climb a tree. Explain that the Savior saw Zacchaeus and called him by name. Testify that the Savior also knows each of the children and their names.
- Bring an empty picture frame to class, or make one out of paper. Invite each child to take turns holding the frame around his or her face while the rest of the class says, “Heavenly Father and Jesus know [child’s name].”
- Invite the children to take turns pretending to climb a tree, as Zacchaeus did. Have the rest of the class say, “Heavenly Father and Jesus know [child’s name].”

- Sing together “I Am a Child of God,” *Children’s Songbook*, 2–3, and help the children listen for things that help them know Heavenly Father loves them.

MATTHEW 21:12–14

The temple is a sacred place.

Your testimony of the temple can help the children you teach understand that the temple is a sacred place.

Possible Activities

- Show the picture Jesus Cleansing the Temple (*Gospel Art Book*, no. 51), and tell the story as recorded in Matthew 21:12–14. Help the children find images of money and animals in the picture. Then discuss why the Savior wanted the money changers and the people selling animals to leave the temple.
- Show pictures of temples (for example, see *Gospel Art Book*, 117–21), and ask the children to share how they feel when they see a temple. Tell the children that those feelings are the Holy Ghost telling us that the temple is a special place. Ask the children to act as they would if they were inside the temple. For instance, they could talk in whispers and sit reverently. Sing together “I Love to See the Temple,” *Children’s Songbook*, 95, and invite the children to make a goal to go inside the temple someday.



The temple is the house of the Lord.

MATTHEW 21:28–32

I can be obedient.

Heavenly Father wants us to be obedient. The parable of the two sons is an opportunity to teach about the importance of obedience.

Possible Activities

- Draw a picture of two sons on the board, and use the drawings as you recount the parable in Matthew 21:28–32. Which son did the right thing in the end? Ask the children to name things they can do to be obedient at home. Let them draw pictures of themselves doing one of those things.
- Invite the children to share experiences they have had being obedient to their parents or another guardian or leader. How were they blessed for being obedient? How can they be more obedient in the future?



Teach the Doctrine Older Children

LUKE 19:1–10

When I seek the Savior, I will find Him.

You might use the story of Zacchaeus to help the children think of things they can do to come closer to the Savior.

Possible Activities

- Read Luke 19:1–10, pausing every few verses to discuss what we learn about Zacchaeus. What did Zacchaeus do so that he could see Jesus? How did he respond when Jesus asked him to come down from the tree? Ask each child to share one reason why they would want to see Jesus. If the Savior came to your city, what would you do to prepare?
- Invite the children to think of people they know who, like Zacchaeus, might be seeking the Savior.

Ask the children what they might do to help someone else learn about the Savior.

- Invite the children to share experiences when they felt that Heavenly Father and Jesus Christ were aware of them and loved them.

MATTHEW 21:12–14

The temple is a sacred place that I should respect.

How can the account of the Savior cleansing the temple help you teach the children about the sacredness of temples?

Possible Activities

- Invite the children to read Matthew 21:12–14. Show the picture Jesus Cleansing the Temple (*Gospel Art Book*, no. 51), and ask them which verse is depicted in the picture. Ask them to draw pictures of what the temple might have looked like before and after Jesus cleansed it.
- Invite the children to share how they have felt when they went inside a temple, visited temple grounds, or looked at pictures of temples. What helped them know the temple is a sacred place?
- Invite one or more youth to come to class and talk about how they have prepared to enter the temple. If they have been to the temple, ask them to talk about how they felt when they were there.

- Cut a picture of a temple into puzzle pieces, and give each child one piece. Ask the children to write on the back of their puzzle piece one thing they can do to prepare to enter the temple. As each child shares an idea, add his or her piece to the puzzle.

MATTHEW 23:25–28

I need to be righteous in my actions and my desires.

Jesus taught the scribes and Pharisees about the importance of truly living the gospel—not just pretending to be righteous. What would help the children understand this truth?

Possible Activities

- As you read Matthew 23:25–28 with the children, consider sharing this definition of *hypocrite* from the Bible Dictionary: “One who pretends to be religious when he is not.” Why is it bad to be a hypocrite?
- Show the children a cup that is clean on the outside but dirty on the inside to help illustrate the metaphor in Matthew 23:25. How can we make sure we are clean and pure on the inside?



Encourage Learning at Home

Help the children pick a principle or activity from class to share with their families at home.

Improving Our Teaching

Support the children’s parents. “Parents are the most important gospel teachers for their children—they have both the main responsibility and the greatest power to influence their children (see Deuteronomy 6:6–7). As you teach children at church, prayerfully seek ways to support their parents in their essential role” (*Teaching in the Savior’s Way*, 25).

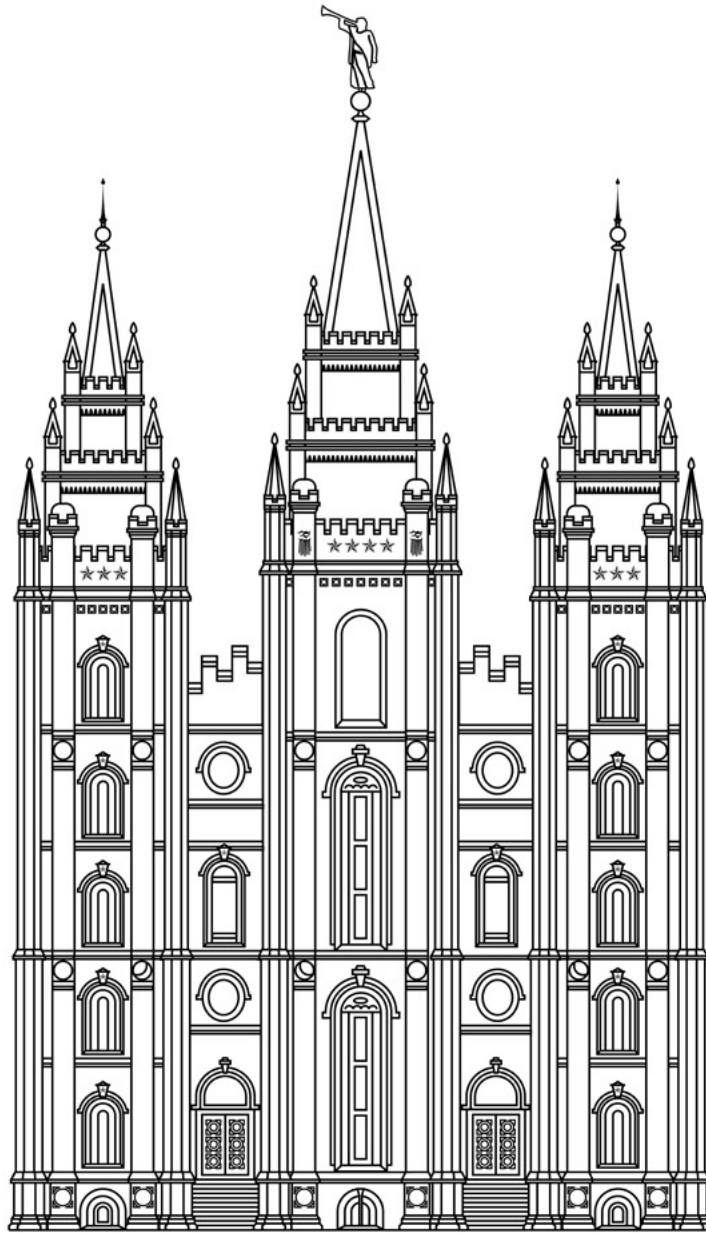

The temple is a sacred place (Matthew 21:12-14).



The Second Coming, by Harry Anderson

MAY 27–JUNE 2

Joseph Smith—Matthew 1; Matthew 25; Mark 12–13; Luke 21

“The Son of Man Shall Come”

Ponder what the children you teach need to learn about Joseph Smith—Matthew 1; Matthew 25; Mark 12–13; and Luke 21. Feel free to adapt the ideas for older children in this outline for younger children and vice versa.

RECORD YOUR IMPRESSIONS _____



Invite Sharing

Show a picture related to one of the stories in this week’s reading (such as the picture of the ten virgins from this week’s outline in *Come, Follow Me—For Individuals and Families*). Ask the children to share what they know about the story.



Teach the Doctrine

Younger Children

JOSEPH SMITH—MATTHEW 1:31

Before Jesus comes again, the gospel will be preached in all the world.

Jesus said that before He comes again, the gospel will be preached in all the world. The children can help fulfill this prophecy by sharing the gospel.

Possible Activities

- Show a map, globe, or picture of the earth (see *Gospel Art Book*, no. 3) and help the children say, “This Gospel . . . shall be preached in all the world” (Joseph Smith—Matthew 1:31). Why does God want all of His children to hear His gospel?
- Invite the children to march in place as you sing together “I Want to Be a Missionary Now” and “Called to Serve,” *Children’s Songbook*, 168, 174. Invite full-time or recently returned missionaries to share their experiences with sharing the gospel and help the children think of ways they can share the gospel.



Photo Courtesy of NASA Johnson Space Center

MATTHEW 25:14–30**I can use the gifts God has given me.**

Young children are discovering their gifts and abilities. Help them understand that these gifts and abilities come from Heavenly Father.

Possible Activities

- Bring several coins to use as you tell the parable of the talents, found in Matthew 25:14–30. You could ask three children to represent the three servants. Explain that in Jesus's day, *talents* referred to money, but today *talents* can mean our gifts and abilities.
- Ask the children to name ways their parents, siblings, teachers, or friends have helped them. What abilities do these people have that help them serve others?
- Write a small note to the children telling each of them about the gifts or abilities you notice in them. Wrap each note like a gift and invite the children to open their "gifts." Encourage them to improve their gifts and use them to serve others.

MATTHEW 25:31–46**Jesus wants me to serve others.**

We serve Heavenly Father and Jesus Christ by serving people around us. Even young children can serve others.

Possible Activities

- Summarize the parable in Matthew 25:34–46. Help the children understand that when we are serving others, we are serving Jesus.
- Hold up a picture of a child in your class with a picture of Jesus hidden behind it. What can we do to serve this child? Remove the child's picture and explain that when we serve each other, we are serving Jesus.

- Invite the children to draw pictures of themselves serving others in the ways the Savior describes in Matthew 25:35–36. Ask the other children to guess what they are drawing.
- Invite the children to share experiences when someone has shown Christlike service to them or their families.



Teach the Doctrine

Older Children

JOSEPH SMITH—MATTHEW 1:31**Before Jesus comes again, the gospel will be preached in all the world.**

The children you teach can help preach the gospel in all the world before the Savior's Second Coming.

Possible Activities

- Invite the children to share blessings they have received or will receive because they are members of Christ's Church. Read together Joseph Smith—Matthew 1:31, and ask the children how the gospel will bless God's children throughout the world.
- Show the children a map of the world or of your country, and help them identify some places where a family member or friend has preached the gospel on a mission.
- Invite a few children to come prepared to share how their family members or their ancestors were introduced to the gospel. If possible, ask someone in the ward who served a full-time mission to share an experience with sharing the gospel.
- Ask each child to write the name of someone he or she can talk to about the gospel or invite to church. Also ask the children to list things they can do to be missionaries now.

MATTHEW 25:1-13**I am responsible for my own conversion to the gospel.**

The parable of the ten virgins teaches that we cannot borrow our conversion to the gospel from others. How can you help the children take responsibility for their own conversion?

Possible Activities

- Ask a child and one of his or her parents to come prepared to share how they learned about the parable of the ten virgins at home this week.
- Draw an oil lamp on the board, and label it *testimony*. Give each child a piece of paper shaped like a drop of oil, and ask each child to write on it something he or she will do to become more converted to the gospel. Attach their drops to the board around the lamp.
- Invite the children to help you make a list of things to do to prepare for a special visitor. How are these things similar to or different from ways we can spiritually prepare for the Savior's Second Coming?
- On five strips of paper, write things that cannot be borrowed. On five other strips, write things that can be borrowed. Shuffle the strips, and ask the children to sort them into these two groups. Read

together Matthew 25:1–13. Why is it important not to rely on others for our conversion to the gospel?

MATTHEW 25:14-46**At the Final Judgment, we will give the Lord an account of our lives.**

After the Resurrection, God will judge us based on our obedience to His commandments and acceptance of the Savior's atoning sacrifice. The parable of the talents and the parable of the sheep and goats teach us about this Final Judgment.

Possible Activities

- Invite half of the class to read Matthew 25:14–30 and the other half to read Matthew 25:31–46. Ask the groups to act out the parables for the class.
- Invite the children to read Matthew 25:35–36 in pairs and make a list of things they can do to show their love for Jesus Christ.

**Encourage Learning at Home**

Ask the children to share with their families ways they can be better missionaries and talk with their families about people they can share the gospel with.

Improving Our Teaching

Listen to or act out a story. Because children love stories, look for ways to involve them in the scripture stories you share. They can hold pictures or objects, draw pictures of the story, act out the story, or help tell the story. Repeat the stories to help them recognize important details and gospel teachings.

The Savior wants me to share the gospel (Joseph Smith—Matthew 1:31).

Children all over the world can share the gospel by
♥ showing love and kindness, 🏛️ inviting someone to church,
✋ serving others, and 📖 giving away a Book of Mormon.

Color the hearts to reveal the girl's path as she shares the gospel with her friend.



✋	♥	♥	🏛️	🌍	✋	📖	📖	✋	
♥	♥	🏛️	♥	✋	🏛️	🌍	♥	♥	
📖	🌍	🏛️	📖	♥	♥	🌍	♥	🌍	♥
✋	🌍	🏛️	📖	🌍	🌍	♥	🌍	🏛️	♥
📖	♥	♥	🌍	🏛️	📖	📖	🌍	♥	🌍
♥	✋	🏛️	♥	♥	🌍	🏛️	♥	📖	✋
♥	🏛️	🌍	📖	✋	♥	🌍	🌍	♥	🏛️
🏛️	♥	📖	✋	🏛️	🌍	♥	♥	🌍	🌍
✋	♥	📖	🌍	✋	🏛️	🌍	✋	📖	
♥	✋	🏛️	♥	🌍	♥	♥	🌍	✋	
📖	♥	♥	🌍	♥	✋	🏛️	♥	♥	





The Last Supper, by Carl Heinrich Bloch

JUNE 3-9

John 13-17

“Continue Ye in My Love”

Pray to know the needs of the children you teach as you read John 13-17. *Come, Follow Me—For Individuals and Families* and this outline can help you understand the doctrine and give you ideas to teach the children in your class.

RECORD YOUR IMPRESSIONS _____



Invite Sharing

To help the children share what they are learning at home, pass around a paper heart and invite each child to share something he or she does to show love for others when it is his or her turn to hold the heart.

in John 13:1-17. Invite the children to point out details from the story that are in the pictures.

- Show pictures of Jesus serving others (see the *Gospel Art Book* or Church magazines for ideas). Let the children take turns holding the pictures as you tell the stories depicted (let them help tell the stories if they can).
- Ask the children how they feel when someone helps them. Let the children draw pictures of how they can follow Jesus’s example by serving someone.



Teach the Doctrine

Younger Children

JOHN 13:1-17

Jesus wants me to serve others.

The story of Jesus washing His Apostles’ feet is an example of humble service. How can you inspire the children to follow Jesus’s example?

Possible Activities

- Use the picture in this week’s outline in *Come, Follow Me—For Individuals and Families* to help tell the story

JOHN 13:34-35; 14:15

I show my love for Jesus Christ by keeping His commandments.

How can you help the children understand that their obedience is a sign that they love Jesus Christ?

Possible Activities

- Give each child a paper heart to decorate. Invite them to hold up their hearts every time they sing

the word “love” in “Jesus Said Love Everyone” and “Love One Another,” *Children’s Songbook*, 61, 136.

- Help the children memorize John 14:15 by holding up their paper hearts as they say, “If ye love me,” and a picture of stone tablets as they say, “Keep my commandments.”
- Invite the children to take turns acting out a kind action they could do for someone to show their love for Jesus. Have the rest of the children guess what they are doing.
- Complete this week’s activity page with the children.

JOHN 14:26-27; 15:26; 16:13-14

The Holy Ghost helps me feel closer to Jesus.

Although the children you teach haven’t yet received the gift of the Holy Ghost, they can learn now how the power of the Holy Ghost works in their lives.

Possible Activities

- Show the picture *The Last Supper* (*Gospel Art Book*, no. 54). Explain to the children that at the Last Supper, Jesus taught His disciples about the Holy Ghost.
- Invite the children to put their hands on their hearts and on their heads. Open the scriptures to Doctrine and Covenants 8:2, and explain that the Holy Ghost can speak to us “in [our] mind and in [our] heart,” or through our thoughts and feelings.
- Turn out the lights and hold up a picture. Then shine a flashlight on the picture. Ask the children how the flashlight is like the Holy Ghost.
- Together with the children, sing “The Holy Ghost,” *Children’s Songbook*, 105, in a “still small voice.” Invite them to listen for things that the Holy Ghost does.



Teach the Doctrine

Older Children

JOHN 13:34-35; 14:15; 15:10-14

I show my love for Jesus Christ by keeping His commandments.

As you read these passages in your personal study, think about the children you teach. How will they be blessed when they understand that their obedience is a sign of their love for the Savior?

Possible Activities

- Help the children memorize John 13:34-35. One way to do this is to sing “Love One Another,” *Children’s Songbook*, 136-37, and help the children learn actions to go with it.
- Invite the children to write on the board ways Jesus has shown He loves us. You might show pictures from the Savior’s life to help them (for ideas, see the *Gospel Art Book*). How can we show love for others as He did? Invite each child to stand and share one way he or she will “love one another” (John 13:34).
- Invite a child to read John 14:15. Let the children take turns drawing pictures that represent someone keeping a commandment, while the rest of the children guess what he or she is drawing. For examples of commandments, see *For the Strength of Youth*. How does keeping these commandments show the Savior that we love Him?

JOHN 14:26; 15:26; 16:13

The Holy Ghost guides, comforts, and testifies of truth.

Now that many of the children have received the gift of the Holy Ghost, how can you help them better understand the roles of the Holy Ghost?

Possible Activities

- Give the children the following verses to read in pairs: John 14:26; 15:26; and 16:13. Ask them to find words that teach them what the Holy Ghost does. Write the words on the board.
- Share an experience when the Holy Ghost guided you, comforted you, warned you, or testified of truth to you. Invite the children to share any experiences they have had with the Holy Ghost. How did they recognize the Holy Ghost's influence?
- Invite each child to draw his or her face on a paper bag. Shine a flashlight, representing the Holy Ghost, into the bags. Then put things in the bags that block the light, such as a scarf or tissues, to teach that our wrong choices can limit the influence of the Holy Ghost in our lives. Let the children remove the scarf or tissues from their bags to represent repentance.

JOHN 15:1-8; 17:3

Heavenly Father and Jesus want me to know Them.

You will bless the lives of the children forever by helping them come to know Heavenly Father and Jesus Christ.

Possible Activities

- Display a plant as the children take turns reading verses in John 15:1-8. How is Jesus like a vine? How are we like branches? What can we do to stay close to the Savior?
- Read aloud John 17:3. Ask the children what they are doing to know Heavenly Father and Jesus Christ. Share how you are coming to know Them.



Christ taught, "Abide in me" (John 15:4).



Encourage Learning at Home



Encourage the children to ask a family member what they can do to serve him or her. During next week's class, give the children time to share what they did.

Improving Our Teaching

Adapt activities. If you teach younger children, you may find additional ideas that you can adapt for your class in this outline's section for older children. Similarly, activities for younger children can be adapted to teach older children.

I show my love for Jesus Christ by keeping His commandments
(John 13:34-35; 14:15; 15:10-14).

Place a small item, like a bean, at the start of the path. Write the numbers 1, 2, and 3 on separate pieces of paper and put them in a container.

Choose a paper from the container and move the item the number of spaces on the paper. When the item lands on , share a commandment you can keep (see John 14:15). When the item lands on , share a way to show love to others (see John 13:34-35).



And It Was Night,
by Benjamin McPherson

JUNE 10-16

Matthew 26; Mark 14; Luke 22; John 18

“Not as I Will, but as Thou Wilt”

As you read [Matthew 26](#); [Mark 14](#); [Luke 22](#); and [John 18](#), look for principles that you feel the children need to understand.

RECORD YOUR IMPRESSIONS _____



Invite Sharing

Show pictures of the events in these chapters, such as *Gospel Art Book*, nos. 54, 55, and 56, and invite the children to tell what is happening in the pictures.



Teach the Doctrine

Younger Children

MARK 14:22-25; LUKE 22:19-20

The sacrament helps me think about Jesus.

Help the children understand that partaking of the sacrament is a chance to think about Jesus.

Possible Activities

- Summarize the account of Jesus introducing the sacrament. You might use “Chapter 49: The First Sacrament,” *New Testament Stories*, 124–26, or the corresponding video (LDS.org). See also the video

“Sacrament” (LDS.org). Help the children understand that we remember Jesus during the sacrament.

- Ask children if they know what the sacramental bread and water represent. Explain that these emblems help us remember that Jesus died for us and rose from the dead. Display a piece of bread and a cup of water while you help the children memorize the phrase “In remembrance of [Him]” (Luke 22:19).
- Ask the children to close their eyes and think of someone they love, and then invite them to tell you about that person. Ask them to close their eyes again, think of the Savior, and then share things they know about Him. Encourage them to think about Jesus during the sacrament each week.
- Invite the children to demonstrate what they can do to remember Jesus and be reverent during the sacrament.
- Help the children make the booklet described on this week’s activity page. Suggest that they use it to help them think about Jesus during the sacrament.
- Help the children search some Church magazines for pictures of Jesus and create a collage they can look at during sacrament meeting.

MATTHEW 26:36–46

Jesus suffered for me because He loves me.

Consider how you can help the children feel Jesus’s love for them as you discuss the account of His suffering in Gethsemane.

Possible Activities

- Invite the children to think of a time when they felt sad or hurt. As appropriate, invite a few children to share. Show the picture in this week’s outline in *Come, Follow Me—For Individuals and Families*. Explain that Jesus, in some way that we do not fully understand, felt all the pain and sadness that everyone has ever felt. This means that He can help us feel better when we feel sad, hurt, or upset.
- Sing “I Feel My Savior’s Love,” *Children’s Songbook*, 74–75, with the children. Invite them to share ways in which they have felt Jesus’s love.



Christ Praying in the Garden of Gethsemane, by Hermann Clementz



Teach the Doctrine
Older Children

MARK 14:22–24

The sacrament helps me remember Jesus Christ and His sacrifice for me.

How can you help the children have a more meaningful experience with the sacrament?

Possible Activities

- Invite the children to take turns reading the verses in Mark 14:22–24 (see also Joseph Smith Translation, Mark 14:20–24 [in the Bible appendix]) and Doctrine and Covenants 20:75–79. What words and ideas are similar in the two passages?
- Ask the children what they do to help them think about Jesus during the sacrament. Help them find scriptures or words from sacrament hymns that they could read during the sacrament, and then list them on a card that the children can refer to the next time they take the sacrament. Sing a few of these songs with the children (see *Hymns*, nos. 169–97).
- Write key phrases from the sacrament prayers on the board, and help the children memorize them. What do these phrases mean? Why are we grateful that we get to renew our baptismal covenants every week?
- Invite an Aaronic Priesthood holder to tell the children about his experience preparing, blessing, or passing the sacrament. What helps him prepare to do this? How does he feel as he does it? How do the bread and water remind him of the Savior?
- Ask children who have been baptized to share what they remember about their baptisms. How did they feel? What covenants did they make? (see Mosiah 18:8–10). Tell them that every week when we partake of the sacrament, it can be like being baptized again—we can be forgiven of our sins, and we renew our covenants.

MATTHEW 26:36–42

In Gethsemane, Jesus Christ took upon Himself my sin and pain.

Knowing about what Jesus did for us in Gethsemane can help the children repent of their sins and turn to the Savior when they experience difficult trials.

Possible Activities

- Invite the children to read Matthew 26:36–42, looking for words or phrases that describe how Jesus felt in Gethsemane. What was Jesus experiencing that caused Him to feel this way? Give the children the opportunity to share their feelings about Jesus and His sacrifice for us.
- Invite the children to share a time when they were sad or in pain. Ask them if they know anyone who has felt the same thing. Explain that in Gethsemane, Jesus felt all the pain and sadness that everyone has ever felt. He did this so He could comfort us when we need it (see Alma 7:11–12).
- Give a child a stick that is longer than the width of the classroom doorway, and ask him or her to hold it horizontally and try to walk through the door. Explain that the stick represents our sins, which keep us from entering God’s kingdom. Take the stick away to demonstrate that Jesus took upon Himself our sins so that we can be forgiven when we repent.

LUKE 22:39–44

I can follow Jesus’s example by being obedient to Heavenly Father.

Jesus showed obedience to the Father when He said, “Not my will, but thine, be done” (Luke 22:42). How can you help the children learn from Jesus’s example?

Possible Activities

- Memorize with the children the phrase “Not my will, but thine, be done” (Luke 22:42) and discuss what it means. What can we do to obey Heavenly Father’s will?

- Help the children identify some commandments they have obeyed. Ask: What blessings did you receive by being obedient to Heavenly Father, even when it was hard? Invite them to share their experiences and testimonies.

LUKE 22:41–43

I can receive help when I pray.

When Jesus prayed in Gethsemane, an angel appeared to strengthen Him. Do the children you teach understand that they too can pray to Heavenly Father for strength?

Possible Activities

- Tell the story of Luke 22:41–43 to the children (perhaps by using “Chapter 51: Jesus Suffers in the Garden of Gethsemane,” *New Testament Stories*, 129–32, or the corresponding video on LDS.org). Explain that when Jesus prayed, Heavenly Father sent an angel to strengthen Him. Who does Heavenly Father send to strengthen us?
- Display the image of the angel comforting Christ in this week’s outline in *Come, Follow Me—For Individuals and Families*, and share an experience in which you felt strengthened by Heavenly Father.



Encourage Learning at Home

Invite the children to share with their families what they will do during the sacrament to remember Jesus.

Improving Our Teaching

Bear testimony to your class. A testimony can be as simple as “I know that Heavenly Father loves each of you” or “I feel good inside as I learn about Jesus Christ.”

The sacrament helps me think about Jesus (Mark 14:22-25).

Color the pictures. Cut around the solid rectangle, and then fold on the dotted lines to make a booklet with the pages in order.

2

We take the sacrament today as Jesus taught in His day.



3

I can listen while the sacrament prayers are said.

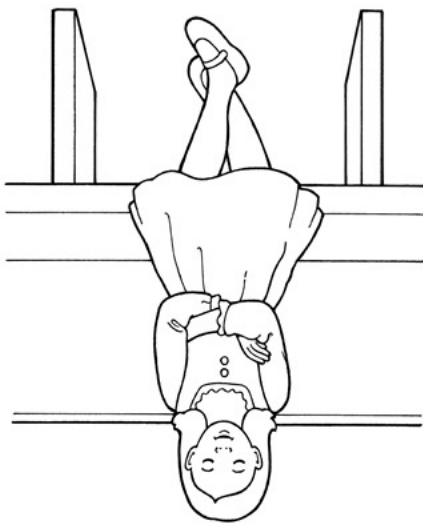

The Sacrament

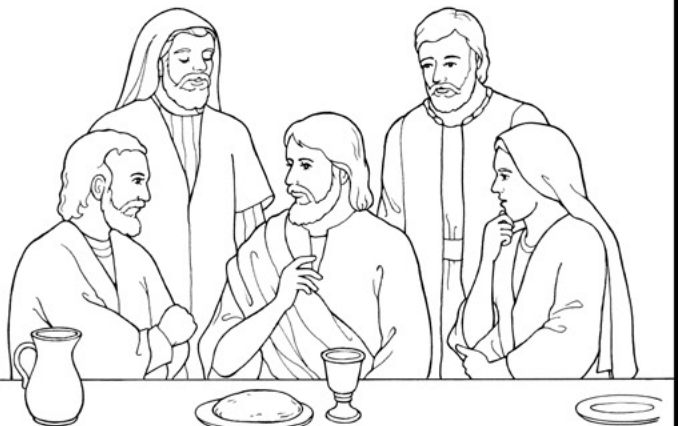

Jesus introduced the sacrament to His Apostles.



I can think of Jesus during the sacrament.

1

4





Ecce Homo, by Antonio Ciseri

JUNE 17-23

Matthew 27; Mark 15; Luke 23; John 19

“It Is Finished”

Begin your preparation by reading Matthew 27; Mark 15; Luke 23; and John 19. Prayerfully seek to understand the needs of the children.

RECORD YOUR IMPRESSIONS _____



Invite Sharing

Let each child hold the picture from this week’s outline in *Come, Follow Me—For Individuals and Families*. While holding the picture, each child could share something he or she knows about how Jesus died.



Teach the Doctrine

Younger Children

MATTHEW 27:11-66; LUKE 23; JOHN 19

**Because Jesus died for me,
I can be resurrected.**

Little children might be upset by the accounts of Jesus’s Crucifixion. “Chapter 52: The Trials of Jesus” and “Chapter 53: Jesus Is Crucified,” *New Testament Stories*, 133–38, or the corresponding videos (LDS.org) provide a good model for how you might appropriately share this story with them.

Possible Activities

- Show the picture in this week’s outline in *Come, Follow Me—For Individuals and Families* as you

tell about Jesus’s trial, Crucifixion, and burial (see also *Gospel Art Book*, nos. 57 and 58). Invite the children to share what they know about these events. Emphasize that on the third day, Jesus was resurrected, meaning that He came back to life.

- Ask the children to name some things their parents do for them that they cannot do for themselves. Show a picture of the Savior. Explain that because of Jesus, we can be resurrected—something we cannot do ourselves.
- Show a picture of someone you know who has died. Share your testimony that because of Jesus that person will live again.



The Burial, by Carl Heinrich Bloch

MATTHEW 27:26-37; LUKE 23:34

I can forgive others as Jesus did.

How will you help the children understand how to forgive those who are unkind, as Jesus did?

Possible Activities

- Describe how the soldiers were unkind to Jesus (see Matthew 27:26-37), and then read Luke 23:34. Explain that when we forgive others, we let go of bad feelings toward them and show love.
- Share scenarios in which someone says or does something unkind. Invite the children to show how they would forgive that person.
- Write words or phrases from “Help Me, Dear Father,” *Children’s Songbook*, 99, on the board. Invite the children to sing the song multiple times, erasing some words each time until they have learned the entire song. According to this song, whom should we forgive? Who can help us when forgiving is hard?
- Search a recent issue of the *Friend* or *Liahona* to find a story about a child who forgave someone. Share this story with the children.

LUKE 23:32-33, 39-43

Because Jesus suffered and died for me, I can repent and be forgiven.

Although children under age eight are not yet accountable, it is important for them to start learning now how to repent of the wrong choices they make.

Possible Activities

- Summarize Luke 23:32-33, 39-43, and point out the two thieves in picture 57 in the *Gospel Art Book*. Explain that when the first thief made fun of Jesus, the second thief admitted that he had done something wrong—he was beginning to repent.
- Read Doctrine and Covenants 19:16 to the children. Why did Jesus suffer for us?
- Show the video “The Shiny Bicycle” (LDS.org). Explain that Heavenly Father and Jesus Christ can help us fix our sins and mistakes and receive forgiveness.
- Let the children make chalk marks on the board to represent wrong choices. Then ask them to erase the board to represent repentance. Show a picture of the Savior, and testify that we can repent because of Him.



Teach the Doctrine Older Children

MATTHEW 27:11-66; LUKE 23; JOHN 19

Jesus died for me because He loves me.

Why are you grateful that Jesus Christ died for you? Consider how you can help the children understand the significance of the Savior’s sacrifice for them.

Possible Activities

- List key events from Matthew 27:11-66 (for help doing this, see “Chapter 52: The Trials of Jesus” and “Chapter 53: Jesus Is Crucified,” *New Testament Stories*, 133-38). Invite the children to study these verses and place the events in the correct order.
- Show the videos “Jesus Is Condemned before Pilate” and “Jesus Is Scourged and Crucified” (LDS.org). (See also “The Atonement,” LDS.org.) Why was Jesus willing to suffer for us?
- Ask a child to read Matthew 27:54, and invite the children to share things about Jesus that help them know He is the Son of God.
- Ask the children what they learn about the Crucifixion from “Behold the Great Redeemer Die,” *Hymns*, no. 191, or another sacrament hymn.

MATTHEW 27:26–37; LUKE 23:34**I can forgive others as Jesus did.**

It can be hard to forgive others. The children you teach will be blessed as they follow the Savior's example and forgive everyone.

Possible Activities

- Invite the children to take turns reading about the soldiers being unkind to Jesus in Matthew 27:26–37 and Jesus forgiving them in Luke 23:34. (See the insight provided by the Joseph Smith Translation in Luke 23:34, footnote c.) What do we learn from Jesus's example?
- Write on the board *What can you do to forgive someone who is unkind to you?* Let the children take turns writing ideas on the board, such as *Pray to have kind feelings toward the person* or *Think of something good about the person.*
- Invite the children to draw pictures of situations in which someone is unkind and how they would forgive that person. Let them share their drawings with the class.

LUKE 23:32–33, 39–43**Because Jesus suffered and died for me, I can repent and be forgiven.**

This lesson is a good time to testify that because of Jesus Christ, we can repent of our sins and be forgiven.

Possible Activities

- Invite a child to read Luke 23:32–33, 39–43. Explain that the two people being crucified with Jesus were thieves. How did one of the thieves show that he was beginning to repent?
- Write the following sentence on the board, leaving blanks for the italicized words: "I can be *forgiven* when I *repent* because of the *Atonement of Jesus Christ*." Give the children clues to help them fill in the blanks in this phrase
- Invite a child to hold a bag, and fill it with small rocks as the other children name wrong choices someone could make. Help the children compare the bag to the spiritual burden we carry when we sin. How is repentance like taking rocks out of the bag?
- Use the article "You Can Repent and Forgive" (*Friend*, Aug. 2015, 10) to teach the children how to repent.

**Encourage Learning at Home**

Encourage the children to think of someone they need to forgive and decide on one thing they will do to show that person that they have forgiven him or her.

Improving Our Teaching

Learn to recognize revelation. Revelation often comes "line upon line" (2 Nephi 28:30), not all at once. As you pray and ponder the scriptures and this outline, you will find that ideas and impressions can come anytime and anywhere—as you travel to work, do household chores, or interact with family and friends.

Because Jesus died for me, I can be resurrected (Matthew 27:11-66; John 19).

Read the scriptures and draw lines to match the people with what they did during Jesus's last hours on earth.



Pilate
Matthew 27:1-2, 11-24



Simon
Matthew 27:32



Soldiers
Matthew 27:27-35



Two Thieves
Matthew 27:44



Mary, Jesus's Mother
John 19:25



John
John 19:25-27



Joseph of Arimathea
Matthew 27:57-60



Buried Jesus



Comforted Mary



Were Crucified



Judged Jesus



Mourned



Crucified Jesus



Carried Jesus's Cross



Feed My Sheep, by Kamille Corry

JUNE 24-30

Matthew 28; Mark 16; Luke 24; John 20–21

“He Is Risen”

Begin your preparation by reading Matthew 28; Mark 16; Luke 24; and John 20–21. *Come, Follow Me—For Individuals and Families* and this outline can help you select principles in these chapters that will be meaningful to the children in your class.

RECORD YOUR IMPRESSIONS _____



Invite Sharing

Seeing a picture can help children remember things they learned at home or in other settings. Perhaps you could show the picture in this week’s outline in *Come, Follow Me—For Individuals and Families* and ask the children to share what they know about the story shown in the picture.



Teach the Doctrine

Younger Children

MATTHEW 28; MARK 16; LUKE 24; JOHN 20:1–23

**I will live again after I die,
just as Jesus did.**

The Atonement of Jesus Christ, including His Resurrection, is the most important event in history, and it is the foundation of Christian faith. As you read about the Resurrection, ponder how you will help the children build their faith in Jesus Christ.

Possible Activities

- Tell the story of Jesus’s Resurrection in your own words. Ask the children to take turns repeating the story back to you. You might refer to “Chapter 54: Jesus Is Risen,” *New Testament Stories*, 139–44, or the corresponding video (LDS.org). Explain that when Jesus died, His spirit left His body. When He was resurrected, His spirit and His body came together again.
- Invite several ward members to act as the soldiers, the angels, Mary Magdalene, Peter, John, the disciples, and Thomas and tell what they witnessed after Jesus’s Resurrection.
- Show the video “What Happens after We Die?” (LDS.org), and tell about someone you know who has died. Share your testimony that everyone will be resurrected someday. Invite the children to share their testimonies.
- Consider singing together “Did Jesus Really Live Again?” and “When He Comes Again,” *Children’s Songbook*, 64, 82. Ask the children to imagine what it will feel like to see the resurrected Jesus. Let them share their thoughts with the class.

JOHN 20:24–29

I can have faith in Jesus Christ even though I can't see Him.

Consider how you can help the children understand what faith is and how they can exercise faith in the Savior.

Possible Activities

- Show the picture Christ Approaches Thomas (LDS.org) while you tell about Thomas's experience in John 20:24–29. Repeat the story later in the lesson, but this time ask the children to provide some of the details.
- Show a box with an object inside that the children can't see, and describe the object to the children. Ask them if they believe the object is really inside the box and why. Then show them the object, and explain that faith is believing in things we can't see. The most important faith we can have is faith in Jesus Christ.



Behold My Hands, by Jeff Ward

JOHN 21:15–17

I can show my love for Jesus by serving others.

How can you inspire the children to love and help those around them?

Possible Activities

- Read John 21:15–17, or show the video “Feed My Sheep” (LDS.org). Jesus didn't want Peter to spend all of his time fishing. Instead, He wanted Peter to share the gospel and invite everyone to come to Him. Give each of the children a paper sheep, and ask them to write on it something they can do to help feed Jesus's sheep.
- Ask several children ahead of time to share things they are doing to love and serve others, or ways others have served them.
- Write the name of every child in your class on pieces of paper cut into the shape of sheep, and scatter these sheep around the room. (Include the names of children who don't attend regularly.) Invite the children to gather the sheep by finding the one with their name on it. What can we do to serve any lost sheep we might know?



Teach the Doctrine
Older Children

MATTHEW 28; MARK 16; LUKE 24; JOHN 20:1–23

Because Jesus was resurrected, everyone will be resurrected.

It's natural for children to wonder what happens after we die. Consider how you can teach about the Resurrection in a way that will build their faith.

Possible Activities

- Invite the children to close their eyes and imagine that they are sitting by Jesus's tomb while you read John 20:1–17 or summarize the story of His Resurrection (see also “Chapter 54: Jesus Is Risen,” *New Testament Stories*, 139–44, or the corresponding video on LDS.org). What would it have been like to see the resurrected Savior?

- Ask each child to study the experience of someone who saw the resurrected Savior and share with the rest of the class what he or she learned.
- Watch one or more of these videos with the children: “Jesus Is Laid in a Tomb,” “Jesus Is Resurrected,” “Christ Appears on the Road to Emmaus,” and “The Risen Lord Appears to the Apostles” (LDS.org).

JOHN 20:24-29

I can have faith in Jesus Christ even though I can't see Him.

What are the children you teach doing to strengthen their faith in Jesus Christ? How can you help them?

Possible Activities

- Invite a few children to take turns reading verses in John 20:24-29. (See also the video “Blessed Are They That Have Not Seen, and Yet Have Believed,” LDS.org.)
- Write each word in the phrase “Blessed are they that have not seen, and yet have believed” on separate pieces of paper. Invite the children to put the words in order. Invite them to tell of experiences in which they felt the Savior’s love even if they did not see Him.
- Invite the children to draw pictures of things they can do to strengthen their faith. As they draw, share

what you have done to strengthen your faith in Jesus Christ.

JOHN 21:1-17

I can show my love for Jesus by feeding His sheep.

Children can greatly influence those around them. How can you encourage them to strengthen others in the gospel?

Possible Activities

- Before reading John 21:1-17 together, ask the children if they have gone fishing before. What was it like? Ask if anyone ever caught a “multitude of fishes” (John 21:6).
- Read John 21:15-17, but replace Simon’s name with names of the children. Who are Jesus’s sheep? How can we feed His sheep?
- Share a simple snack with the children. As they are eating, ask them how sharing the gospel with someone is like feeding them.



Encourage Learning at Home

Invite the children to use this week’s activity page to teach their families about the last week of the Savior’s life.

Improving Our Teaching

Follow up on invitations to act. When you invite the children to act on what they are learning, follow up on your invitation during the next class. This shows the children that you care about how the gospel is blessing their lives. As they share their experiences, they will be strengthened and will help one another live the gospel.

Because Jesus was resurrected, everyone will be resurrected (Matthew 28; Mark 16; Luke 24; John 20).

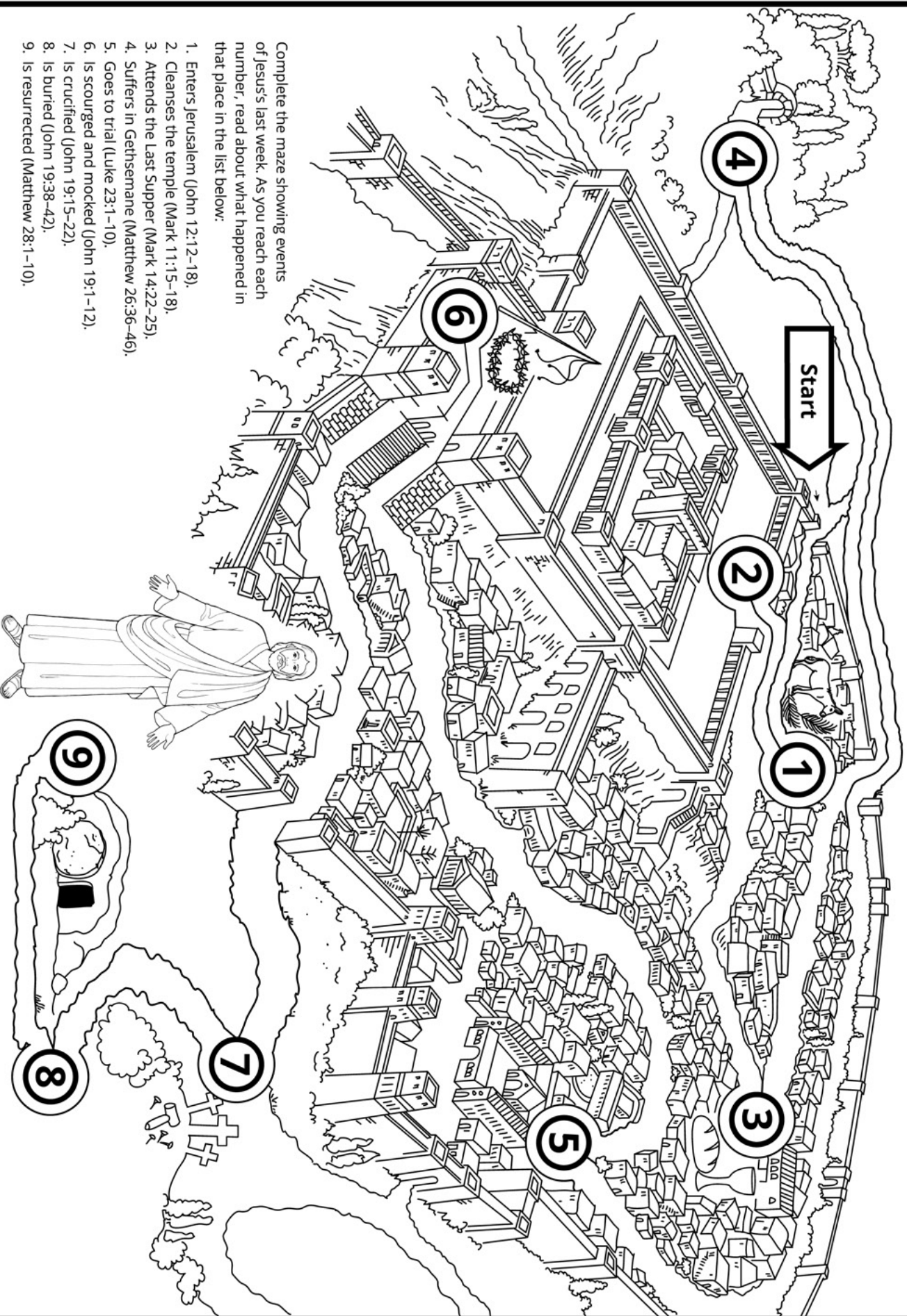

Complete the maze showing events of Jesus's last week. As you reach each number, read about what happened in that place in the list below:

1. Enters Jerusalem (John 12:12-18).
2. Cleanses the temple (Mark 11:15-18).
3. Attends the Last Supper (Mark 14:22-25).
4. Suffers in Gethsemane (Matthew 26:36-46).
5. Goes to trial (Luke 23:1-10).
6. Is scourged and mocked (John 19:1-12).
7. Is crucified (John 19:15-22).
8. Is buried (John 19:38-42).
9. Is resurrected (Matthew 28:1-10).



Day of Pentecost, by Sidney King

JULY 1-7

Acts 1-5

“Ye Shall Be Witnesses unto Me”

Begin your preparation by reading Acts 1-5. Prayerfully seek to understand the needs of the children you teach. *Come, Follow Me—For Individuals and Families* and this outline can also help you.

RECORD YOUR IMPRESSIONS _____



Invite Sharing

Write *Who am I?* on the board. Provide several statements about Peter and ask the children who the statements are about. What else do they know about Peter?

Ask the children why they think the men are looking at the sky. Summarize the account from Acts 1:1-11. See also “Chapter 55: The Apostles Lead the Church,” *New Testament Stories*, 145-47, or the corresponding video (LDS.org).



Teach the Doctrine

Younger Children

ACTS 1:1-11

Jesus Christ leads His Church through prophets and apostles.

Learning about how the Savior led His ancient Church through apostles can help the children gain testimonies of prophets and apostles in our day.

Possible Activities

- Show the full-page picture from this week’s outline in *Come, Follow Me—For Individuals and Families*.

- While the class looks at the picture from this week’s outline in *Come, Follow Me—For Individuals and Families*, invite a child to hold up a picture of the current Apostles. Who leads the Church when Christ is not on the earth? How do they lead the Church?
- Play a matching game with two sets of pictures of the living First Presidency and Twelve Apostles. When a match is made, share the Apostle or President’s name and something about him.
- On the back of a picture of Jesus, tape small pictures of things a prophet might teach about, like baptism or a temple. Let each child take a turn looking at one of the pictures and telling the rest of the class, “The prophet teaches us about [the topic on the picture].”

ACTS 3:1-10

Heavenly Father can bless others through me.

What can you do to help children recognize ways they can bless those around them? Help them learn from the example of Peter and John healing the lame man.

Possible Activities

- Invite the children to do actions that go along with the story in Acts 3:1-10, such as putting out their hands for money and leaping for joy. How did Heavenly Father bless the man who couldn't walk?
- Bring a bag containing pictures that represent ways that we can bless and serve others. Let the children take turns choosing pictures from the bag and sharing how they can bless others in that way.
- Ask the children to share a time when they helped someone.

ACTS 5:1-11

I can be honest.

The early Christians practiced a form of the law of consecration to help care for the poor. Those who owned land sold it and gave the money to the Apostles to be distributed among the Saints according to their needs. Ananias and Sapphira were dishonest about their contribution, thinking they could deceive the Lord's servants.

Possible Activities

- Help the children act out the story of Ananias and Sapphira. Explain that although we won't die when we tell a lie, this story shows how important being honest is to Heavenly Father.
- Sing together a song about honesty, such as "I Believe in Being Honest" (*Children's Songbook*, 149). Help the children understand that part of being honest means always telling the truth and not taking things that belong to someone else.

- Use paper-bag puppets to act out simple situations in which someone is being honest or dishonest. Ask the children to stand up if the person was being honest or sit on the floor if the person was being dishonest.



Teach the Doctrine
Older Children

ACTS 1:8, 22-26

Jesus Christ leads His Church through prophets and apostles.

The children you teach can understand that the Savior's Church today is led by prophets and apostles, just as it was in ancient times.

Possible Activities

- Write on the board *How does Jesus Christ lead the Church when He is not on the earth?* Invite the children to look for answers to the question as you read the Savior's words to the Apostles in Acts 1:8.
- Read together Acts 1:22-26. As a class, identify how the Apostles called a new Apostle.
- Ahead of time, ask a child and his or her parent to read about a recently called Apostle (perhaps on LDS.org). Invite the child to share what he or she learned with the class and, if possible, what the Apostle said about his call in his first general conference message.



The Apostles led the Church after Christ ascended to heaven.

ACTS 3:1-10**Heavenly Father blesses others through me, even if I am not wealthy.**

How can you teach the children that they can bless others, even if they do not have “silver and gold”? (Acts 3:6). How can you help them see opportunities to serve God by serving others?

Possible Activities

- Ask a child to read Acts 3:1–10 while the other children act out the story. (For help, see also “Chapter 56: Peter Heals a Man,” *New Testament Stories*, 148–49, or the corresponding video on LDS.org.) You could also show the video “Peter and John Heal a Man Crippled Since Birth” (LDS.org). In what way was the blessing this man received greater than the money he asked for?
- Pass around a bag of coins. As the children hold the bag, ask them what they can buy with money. Then take back the bag of coins and ask the children what blessings they cannot buy. Invite them to share how they can serve somebody without using money (Acts 3:6).

ACTS 2:36-47**The Holy Ghost bears witness to my heart of gospel truths.**

When children learn to recognize how the Holy Ghost speaks to them, they will be inspired to listen and act on the inspiration they receive.

Possible Activities

- Read together Acts 2:36–37. What does it feel like when the Holy Ghost tells us something in our hearts?
- As a class, make a poster with the words *What shall we do?* at the top. Display the poster each week, and add ways the children can act on what they learn in each week’s lesson.
- Invite the children to find the good things the people did after they were baptized in Acts 2:41–47. What good things can we do to show we are thankful for the gift of the Holy Ghost we received when we were baptized?

**Encourage Learning at Home**

Encourage the children to plan one way they can serve Heavenly Father by helping a member of their families this week.

Improving Our Teaching

Memorize a scripture. Select a scripture passage that you think could help the children in your class, such as Acts 2:38 or Acts 3:19, and help them memorize a phrase from the scripture. Visual aids, hand motions, or gestures can also help children commit scriptures to memory.

Jesus Christ leads His Church through prophets and apostles (Acts 1:1-11).

Color the pictures. Draw a living prophet or apostle in the blank space, and write his name below his picture.
Cut around the outside edge, and fold back and forth along the vertical solid lines.

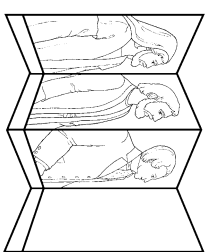

Jesus Christ

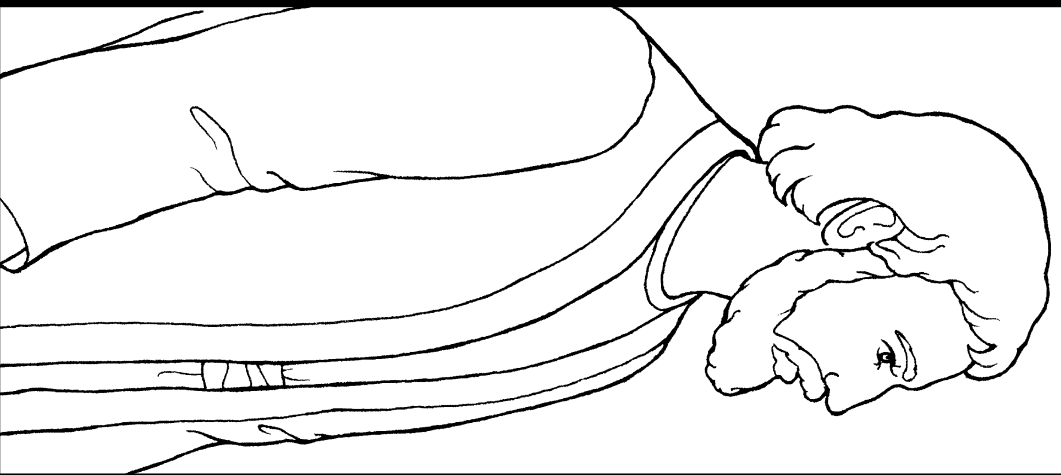

Apostle Peter

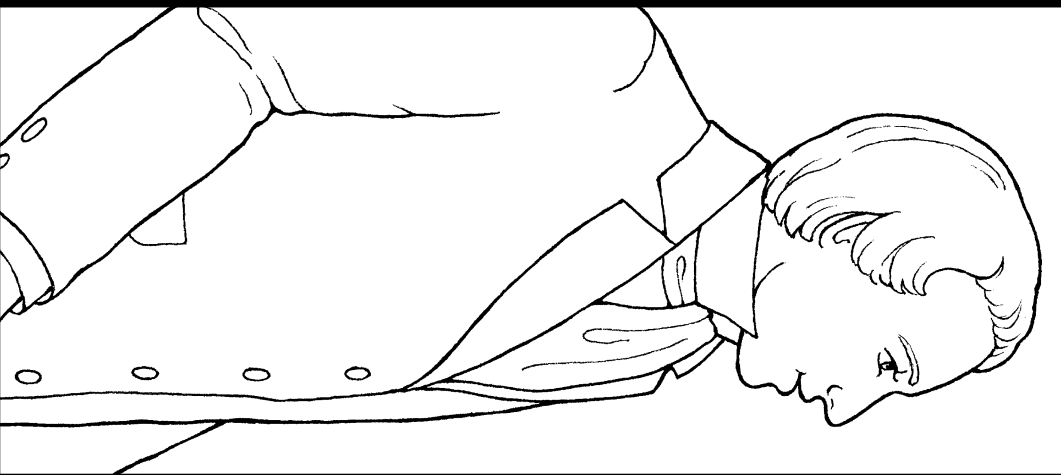

Joseph Smith





May We So Live, by Sam Lawlor

JULY 8-14

Acts 6-9

“What Wilt Thou Have Me to Do?”

Start by reading Acts 6-9. This week’s outline from *Come, Follow Me—For Individuals and Families* can help you understand these chapters. The activities for younger children in this outline may be adapted for older children, and vice versa.

RECORD YOUR IMPRESSIONS _____



Invite Sharing

Write some of the names of people from Acts 6-9 on the board—perhaps Saul or Stephen. Invite the children to share anything they know about one of these people.

Right” (*Children’s Songbook*, 159). Use Acts 7:51-60 to tell the children how Stephen taught about Jesus Christ, even though doing so made the Jewish leaders very angry (see also “Chapter 57: Wicked Men Kill Stephen,” *New Testament Stories*, 150-51, or the corresponding video on LDS.org). How did Stephen stand for the right?

- Give the children several scenarios of children who have to make a choice between right and wrong. Ask the children what they would do to stand for the right.



Teach the Doctrine

Younger Children

ACTS 6-7

I can follow Jesus Christ by standing for the right.

What can the children learn from Stephen about being a follower of Jesus Christ?

Possible Activities

- Help the children create actions to go with a song about choosing the right, such as “Stand for the

ACTS 8:26-39

The Holy Ghost inspires me to share the gospel with others.

Philip followed the promptings of the Spirit and helped an Ethiopian man who was struggling to understand the scriptures. What lessons does this story hold for the children you teach?



Philip Teaching the Ethiopian, by Robert T. Barrett

Possible Activities

- Pull two chairs together to create a chariot. Invite two children to sit in the chariot, one to represent Philip and the other the Ethiopian man. Then tell the story of how Philip taught the gospel to the man from Ethiopia.
- Have you ever felt the Holy Ghost tell you to share the gospel with someone, similar to the experience Philip had in Acts 8:29? Share your experience with the children.

ACTS 9:1-20

When I make a mistake, Heavenly Father invites me to repent and change.

When Jesus told Saul to stop persecuting the Lord's Church, Saul immediately repented and changed. How can this account help the children you teach desire to quickly change when they make a mistake?

Possible Activities

- Summarize the story of Saul's conversion, found in Acts 9:1-20 (see also "Chapter 59: Saul Learns about Jesus," *New Testament Stories*, 154-55, or the corresponding video on LDS.org).
- List or bring in pictures of things that change, such as a tadpole, which changes into a frog, or trees during different seasons. How did Saul change when Jesus Christ visited him?

- Draw a forked road on the board. Invite the children to name places they would like to visit, and write them at the top of one road. What would happen if we turned onto the wrong road? How is repentance like getting back on the right road?
- Ask the children to repeat what Saul said to the Lord: "What wilt thou have me to do?" What does the Lord want us to do?



Teach the Doctrine

Older Children

ACTS 6-7

I will be a witness of Jesus Christ.

How can you help the children you teach learn from Stephen's example of standing as a witness of Jesus Christ?

Possible Activities

- Read Acts 6:5-15 and 7:51-60 with the children. How was Stephen a witness of Jesus Christ? Invite one or more children to pretend to be Stephen and share what they believe in and why.
- Invite the children to take turns reading Acts 6:3-10, searching for qualities Stephen had that helped him serve.
- Ask the children to help you think of situations in which they can stand as witnesses of Jesus Christ and His gospel. Help them role-play some of these situations. Ask the children to read Mosiah 18:9. Point out that being a witness of Jesus Christ is included in the promises we make at baptism.
- Write the names *Stephen* and *Philip* on the board. Under Stephen's name, write ways we can be examples to others. Under Philip's name, write ways we can share the gospel with others. How does being an example of a disciple of Jesus Christ help us to share the gospel?

ACTS 8:5–24**The priesthood is a priceless gift from God.**

Satan promotes the message that material things bring us happiness. How can you use the story of Simon to help the children value spiritual things such as the priesthood and its blessings?

Possible Activities

- Summarize the story of Simon, found in Acts 8:5–24 (see also “Chapter 58: Simon and the Priesthood,” *New Testament Stories*, 152–53, or the corresponding video on LDS.org). Why can’t we receive the priesthood by buying it? How does someone really receive the priesthood? (see Articles of Faith 1:5).
- Give the children pretend money, and display pictures of things that can be bought with money. Ask the children how much of their pretend money they would give for these things. Then show pictures of the sacrament, a temple (representing temple blessings), a baptism, and other blessings we receive through the priesthood. Explain that these gifts from God are priceless and cannot be bought with money.

ACTS 9:1–20**When I make a mistake, Heavenly Father invites me to repent and change.**

When Jesus told Saul to stop persecuting the Lord’s Church, Saul immediately repented and changed. How

can this account help the children you teach desire to quickly change when they make a mistake?

Possible Activities

- Invite the children to fold a piece of paper in half. Ask them to write *Before* on one half and *After* on the other half. Read with the children Acts 8:1–3; 9:1–2; and 9:17–22, looking for words or phrases that describe Saul before and after he saw the Lord.
- Invite a ward member to share his or her conversion story and how being a member of the Church has changed his or her life, as Saul’s life was changed.
- Draw a “road to Damascus” on the board. Invite the children to read Acts 9:6, 11, 18, 20–22, searching for what Saul did to repent and turn to Christ, and write these actions along the road. What do we learn from Saul about how we can become more like Christ?
- Invite the children to draw their favorite part of the account of Saul’s conversion and share their drawing with the class.

**Encourage Learning at Home**

Encourage the children to tell their family their favorite activity from class today and what it taught them.

Improving Our Teaching

Help children learn from the scriptures. Young children may not be able to read much, but you can still engage them in learning from the scriptures. For example, you could read a passage and invite them to stand up or raise their hand when they hear a specific word or phrase that you want to focus on (see *Teaching in the Savior’s Way*, 20).

When I make a mistake, Heavenly Father invites me to change (Acts 9:1-20).

Color the figures and cut them out. Attach the figures to opposite sides of a stick to make a puppet. Use the puppet to tell the story of Saul's conversion. Explain that after his conversion, Saul became known as Paul.

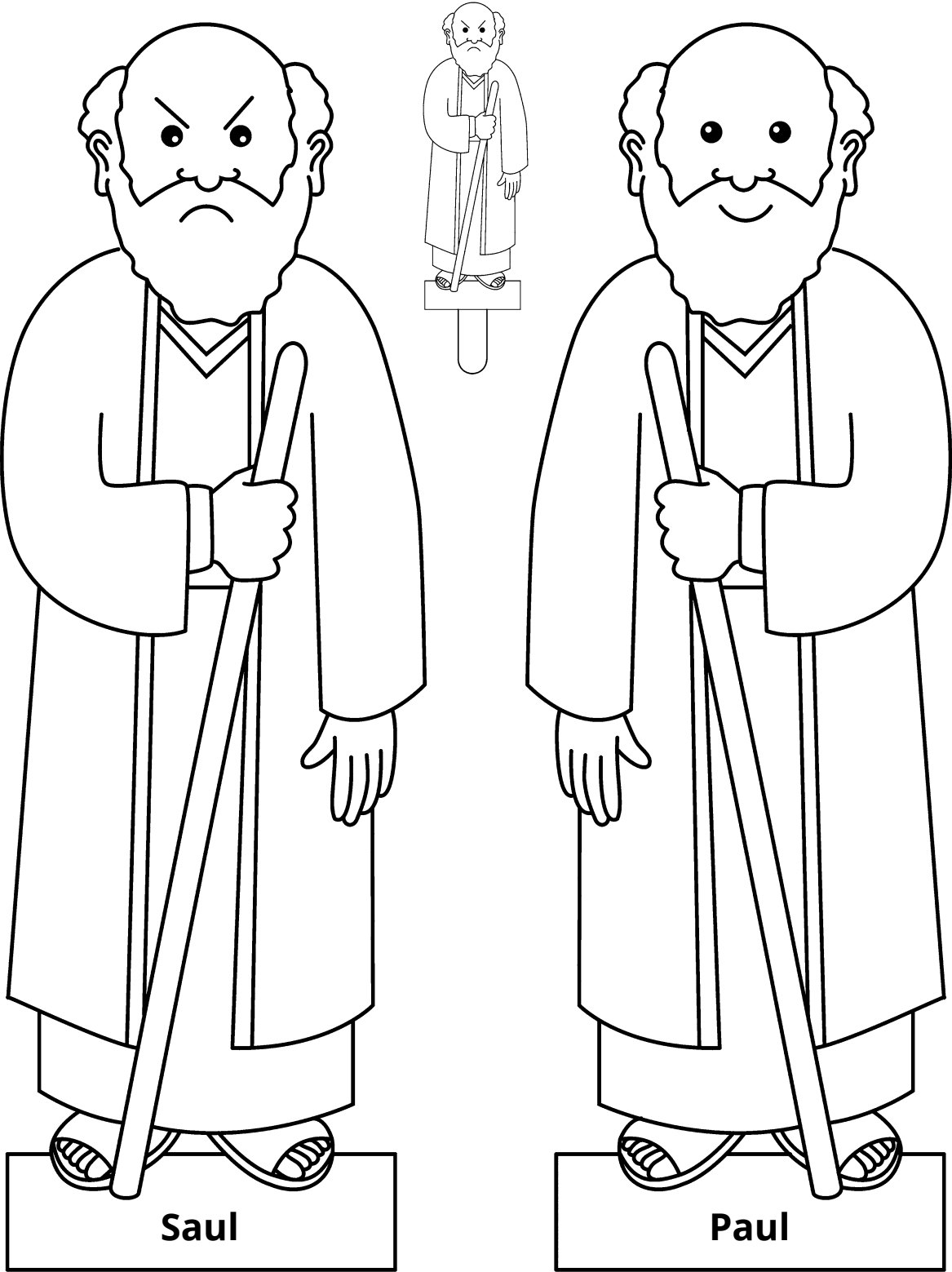



JULY 15–21

Acts 10–15

“The Word of God Grew and Multiplied”

Begin your preparation to teach by reading Acts 10–15. *Come, Follow Me—For Individuals and Families* can help you understand these chapters, and this outline can give you teaching ideas.

RECORD YOUR IMPRESSIONS _____



Invite Sharing

To help the children share what they are learning and experiencing, you could ask them to share things they are doing to show that they believe in Jesus Christ.



Teach the Doctrine

Younger Children

ACTS 10:34–35

Heavenly Father loves all His children.

A fundamental doctrine that even young children can understand is that everyone is a child of God and that He loves all of His children.

Possible Activities

- Show the picture Christ and Children from around the World (*Gospel Art Book*, no. 116) as you read Acts 10:34–35. Explain that in Peter’s time some

people believed that God loved only some groups of people, but Peter learned that God loves all of His children, and He wants all of them to learn the gospel.

- Invite the children to draw a picture of themselves. Share your testimony that Heavenly Father loves each of them and all of His children, no matter what they look like or where they are from.
- Sing a song about loving others with the children—for example, “I’ll Walk with You” (*Children’s Songbook*, 140–41). Invite them to share ways that they can show love to everyone—even to those who are different from them—just as Jesus did.
- Ask each child’s parents ahead of time to share a few admirable characteristics of their child. Share their answers in class, and testify that Heavenly Father loves each of the children.
- Point to each child one by one and say, “Heavenly Father loves [name].” Let the children take turns pointing to one another and saying this phrase.

ACTS 11:26

I am a Christian because I believe in and follow Jesus Christ.

The children you teach may know that members of the Church are often called Mormons because we believe in the Book of Mormon, but do they know that we are also Christians because we believe in Jesus Christ?

Possible Activities

- Read Acts 11:26 to the children. Explain that someone who believes in and follows Jesus Christ is called a Christian, so we are Christians.
- Sing “The Church of Jesus Christ” (*Children’s Songbook*, 77) with the children. How should we act at church, at school, and at home because we are followers of Jesus Christ and belong to His Church?
- Let the children color the badge on this week’s activity page and wear it home.

ACTS 12:1–17

Heavenly Father hears and answers prayers.

The account of the angel freeing Peter from prison teaches powerfully that Heavenly Father answers prayers.

Possible Activities

- Invite the children to act out the account of Peter being freed from prison in Acts 12:1–17 as you summarize the story. How did Heavenly Father answer the prayers of those who were praying for Peter?
- Sing a song about prayer—for example, “We Bow Our Heads” (*Children’s Songbook*, 25)—and create actions to help the children learn how to pray. Invite the children to share examples of things they can thank Heavenly Father for and ask Him for in prayer.

- Show pictures of people praying (see, for example, *Gospel Art Book*, nos. 111 and 112) as you share an experience when Heavenly Father answered your prayers.



Heavenly Father loves us and will answer our prayers.



Teach the Doctrine
Older Children

ACTS 10:34–35; 15:6–11

“God is no respecter of persons.”

The children you teach need to understand that Heavenly Father loves all His children, no matter what they look like, where they are from, or what choices they make.

Possible Activities

- Ask the children if they can tell what someone is like just by looking at them or guessing where they are from. According to Acts 10:35, how does God determine if someone is “accepted with him”?
- Read Acts 10:34–35; 15:6–11 with the children. Explain that in Peter’s time, Jews believed that God did not accept people who weren’t Jews (these people were called Gentiles). But God taught Peter that God loves all of His children, both Jews and Gentiles. Sing together “I Am a Child of God” (*Children’s Songbook*, 2–3). Invite the children to substitute each other’s names for words like *I* or *me*.

- Invite the children to share something unique about someone else in the class. Explain that the statement “God is no respecter of persons” means that Heavenly Father loves all His children, and because He loves them, He wants all of His children to hear the gospel.

ACTS 11:26

A Christian is someone who believes in and follows Jesus Christ.

How can you help the children understand that their words and actions show that they are Christians?

Possible Activities

- Invite the children to read Acts 11:26; 3 Nephi 27:3–8; and Doctrine and Covenants 115:4. Write *Christian* on the board and underline the part that says “Christ.” Ask the children to share what they think it means to be a Christian.
- Ask the children to name different groups they belong to, such as their families or Primary class. Invite them to share reasons why they are grateful to be a Christian and belong to The Church of Jesus Christ of Latter-day Saints. How can we show others we are Christians?
- Display several objects or pictures that represent truths unique to the Church of Jesus Christ, such as a picture of a priesthood blessing. Ask a child to pick one of the objects or pictures and describe how it is a blessing in our Church. Explain that while Christians throughout the world belong to many different churches, we belong to the same Church that Jesus Christ established on the earth.

- Show the video “True Christianity” (LDS.org). Invite the children to draw things they can do to be true Christians.

ACTS 12:1-17

When I pray in faith, Heavenly Father will answer.

Ponder on the times when Heavenly Father has answered your prayers. How can you use these experiences to teach the children that Heavenly Father will hear and answer their prayers in His own way and time?

Possible Activities

- Invite the children to act out the story of the angel freeing Peter from prison in Acts 12:1–17 while you recount the story in your own words.
- Ask the children what they think it means that “prayer was made without ceasing” (Acts 12:5). How were the people’s prayers answered? Invite the children to share experiences in which Heavenly Father answered a personal or family prayer. You could also share an experience in which He answered your prayer in a way that was different from what you expected or wanted. Testify that God loves us, and He will answer our prayers in the way and timing that is best for us.



Encourage Learning at Home

Give the children a picture or object to display in their homes as a reminder for family members to pray together.

Improving Our Teaching

Testify of promised blessings. When you invite Primary children to live a certain principle, share promises God has made to those who live that principle. For example, you can bear testimony of the promised blessings that you have received as you sought answers through prayer.

I am a Christian because I believe in and follow Jesus Christ (Acts 11:26).

Cut out and color the circle. Hang it on a string to wear as a necklace, or wear it as a badge.





JULY 22-28

Acts 16–21

“The Lord Had Called Us for to Preach the Gospel”

After reading Acts 16–21, consider how the promptings of the Spirit and the ideas in this outline can help you with your lesson preparation. Consult “Meeting the Needs of Younger Children” in this manual for additional help.

RECORD YOUR IMPRESSIONS _____



Invite Sharing

Invite the children to tell you how Paul is like missionaries today. Ask, “Have you ever shared the gospel with someone else?”



Teach the Doctrine Younger Children

ACTS 16:25–34

Missionaries teach people about Jesus.

Do the children you teach know what missionaries do? How can you help the children understand that they can share the gospel with others?

Possible Activities

- Help the children act out Acts 16:25–34 as you summarize the account of Paul and Silas sharing the gospel in prison (see also “Chapter 61: Paul and

Silas in Prison,” *New Testament Stories*, 158–60, or the corresponding video on LDS.org). Explain that missionaries today also teach people about Jesus and help them prepare to be baptized.

- Create missionary name tags for the children to wear, and help them write their names on the tags. Teach the children simple statements of doctrine that they can share with others, such as “God is our loving Heavenly Father;” “God speaks through a living prophet;” or “Jesus Christ is our Savior.”
- Invite the children to share details about someone they know who is on a mission. They could draw a picture or write a note to send to a missionary.

ACTS 17:10–12

The scriptures testify of Heavenly Father and Jesus Christ.

Though some of the children you teach might not be able to read yet, you can help them develop a love for the scriptures and see how they testify of the Savior.

Possible Activities

- Place several copies of the scriptures around the room, and let the children find them. Help one of the children read the phrase “They . . . searched the scriptures daily” (Acts 17:11). Invite the children to point to each day of the week on a calendar as they repeat this phrase with you.
- To teach the children that the scriptures testify of Heavenly Father and Jesus Christ, help them turn to a chapter in the scriptures, like Acts 17 or 18, and find instances of the words *God* or *Lord*. You may want to mark these words so the children can find them more easily. Each time they find one of these words, invite them to share something they know about Heavenly Father and Jesus Christ.

ACTS 17:22-31

I am a child of God.

On Mars’ Hill, Paul taught basic truths about the nature of God, including the truths that we are His children and that He is “not far from every one of us” (Acts 17:27). How can you help the children feel close to their Heavenly Father?

Possible Activities

- Invite the children to repeat the phrase “We are the offspring of God” (Acts 17:29), and explain that *offspring* means child. Bear your testimony to each child, one by one, that he or she is a child of God. Ask them how they feel when they hear that they are children of God. Invite them to share how they feel about their Heavenly Father.
- Show pictures of children with their families (if possible, use pictures of the children in your class). Explain that we are the children of our mothers and fathers, and all of us are spirit children of our Heavenly Parents.
- Sing a song about Heavenly Father, such as “I Know My Father Lives” (*Children’s Songbook*, 5). With help from the children, write words or draw pictures on

the board that represent things we learn about Heavenly Father from the song.

- Read to the children these words from Acts 17:27: “He be not far from every one of us.” Talk about times when you have felt close to Heavenly Father, and invite the children to do the same.



Every person is a child of God.



Teach the Doctrine

Older Children

ACTS 16:14-15, 25-34; 18:7-8, 24-28

I can be a missionary now.

How can you help the children be like Paul and share with others what they are learning about the gospel?

Possible Activities

- Invite the children to read Acts 16:14-15, 25-34; 18:7-8, 24-28 and make a list of the people Paul and Apollos shared the gospel with. Then invite them to make a list of people they can share the gospel with. Let the children role-play how they might tell these people about Jesus Christ or invite them to church. You could also invite the children to write notes bearing testimony of a gospel truth to these people.
- Invite current full-time missionaries, returned missionaries, or ward missionaries to visit the class and tell about their experiences with sharing the

gospel. Encourage the children to ask questions about how they can share the gospel with others.

ACTS 17:2-4, 10-12; 18:28

The scriptures testify of Jesus Christ.

All of the prophets testify of Jesus Christ. How can you teach the children to find Him in the scriptures, even when He isn't mentioned by name?

Possible Activities

- Have the children read Acts 17:2-4, 10-12; 18:28, and invite them to look for what these passages have in common. According to these verses, what helped people believe the gospel of Jesus Christ?
- Invite the children to share their favorite stories about Jesus that they have learned from the scriptures this year. On slips of paper, write scripture references that teach about the Savior, and hide them around the room. Then invite the children to find them. Help the children look up the references they find, and ask them to share with each other what each scripture teaches about Jesus.
- Ask the children to help you create a simple chart that they can mark when they read about or learn about Jesus from the scriptures. Display it each week for the rest of the year, and help the children find places in the scriptures that teach about Jesus.

ACTS 17:22-31

I am a child of God.

How can you help the children remember that they are children of God?

Possible Activities

- Show the children a stone, and explain that in Paul's day, people worshipped gods they made out of stone and other materials. Ask the children to read Acts 17:27-29. What do we learn about God from these verses? Explain that *offspring* means children. Ask the children how it makes them feel to know that they are children of God.
- Ask the children to read Acts 17:27. Invite the children to draw pictures of ways they can "feel after" or seek God. When have they felt that He is "not far from [them]"?



Encourage Learning at Home

Encourage the children to look for a scripture this week that teaches about Jesus Christ (this could happen during their personal or family scripture study). Next week, invite them to share what they found.

Improving Our Teaching

Help children become better learners. Your purpose in teaching children is not just to impart truth to them. You should also help them develop into self-reliant seekers of truth. For instance, instead of simply telling the children the story of Paul preaching on Mars' Hill, you could plan activities, like those suggested in this outline, that help them discover truths in the story for themselves.

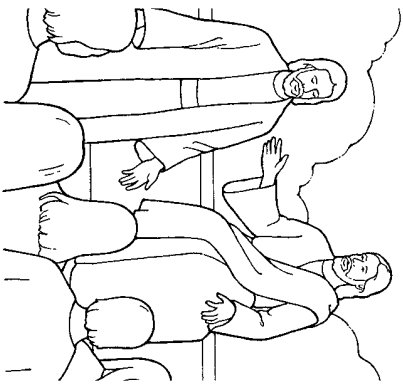

I am a child of God,



And He has sent me here,

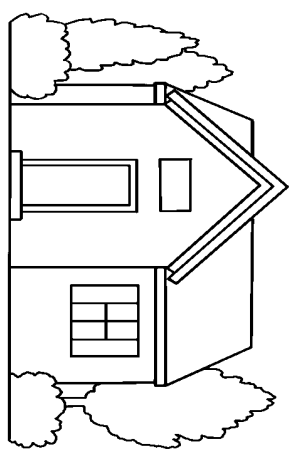

Has given me an earthly home



With parents kind and dear.

I am a child of God (Acts 17:22-31).

Cut out the two long rectangles and tape them together to create one long strip. Fold back and forth on the black lines like an accordion to create a small booklet.

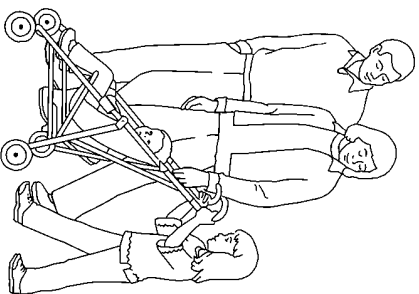

Lead me, guide me, walk beside me,

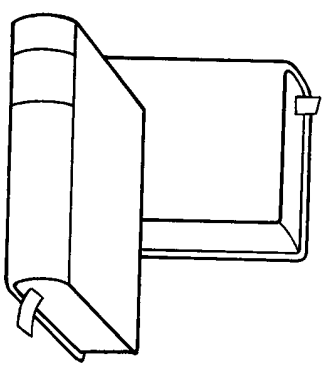

Help me find the way.

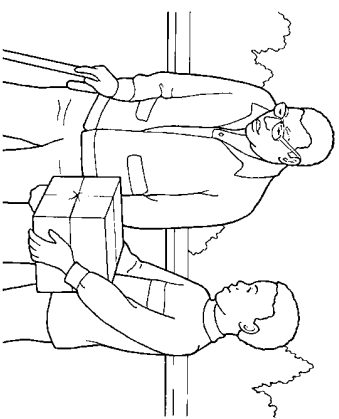

Teach me all that I must do

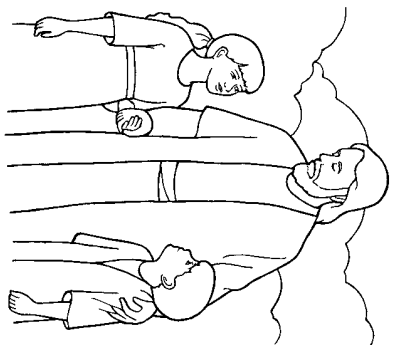

To live with Him someday.



Tape here

Tape here



JULY 29–AUGUST 4

Acts 22–28

“A Minister and a Witness”

As you read accounts from the ministry of Paul the Apostle in Acts 22–28, look for principles that will be meaningful to the children you teach.

RECORD YOUR IMPRESSIONS _____



Invite Sharing

Display pictures of a jail cell, a boat, and a snake. Invite the children to share any stories they know about Paul that have to do with these pictures.

guidance and comfort from God. Ask the children to share times when they felt comforted by God.

- Help the children memorize what Jesus said to Paul: “Be of good cheer.” Ask the children to think of someone they can invite to be of good cheer—perhaps someone who is sad or worried.



Teach the Doctrine

Younger Children

ACTS 23:10–11

Heavenly Father and Jesus care about me and will help me during hard times.

Learning about how the Savior helped Paul can help the children know that Heavenly Father and Jesus care about them.

Possible Activities

- Share the story in Acts 23:10–11 of the Savior visiting Paul in prison. Or show the video “Be of Good Cheer” (LDS.org), which portrays this story. Share a time when you had a trial and received

ACTS 26:1–29

I can share my testimony with others.

Reviewing Paul’s testimony before King Agrippa can help the children learn how to share what they know is true.

Possible Activities

- Bring a crown to class and let a child wear it and pretend to be King Agrippa. Invite another child to stand before the king to represent Paul as you summarize Paul’s testimony and the reaction of King Agrippa, found in Acts 26:1–29 (see “Chapter 63: Paul Finishes His Mission,” *New Testament Stories*, 162–66, or the corresponding video on LDS.org). Explain that we can share our testimonies with others, as Paul did.

- Ask the children to listen while you sing or read a song about testimony, such as verse 2 of “Testimony” (*Hymns*, no. 137) or “I Know My Father Lives” (*Children’s Songbook*, 5). Invite the children to raise their hands when they hear something they can bear testimony about. You may want to sing the song several times; invite the children to join you once they’re familiar with the words. Ask them to share some things about the gospel that they know are true.
- Use this week’s activity page to help the children think about something they could say when they bear their testimony. Invite them to share their testimony with someone in their family.

ACTS 27

Prophets warn me of danger.

Consider how the account of Paul’s shipwreck can teach the children that prophets see danger that we can’t see.

Possible Activities

- Invite the children to pretend that they are on a ship that is being wrecked in a storm. Read Paul’s warning to the people, found in Acts 27:9–10, and share the story of the shipwreck that happened because they didn’t listen to his warning (see verses 11, 39–44). Show a picture of the President of the Church. What kinds of warnings does he give us?
- Place several pictures or objects around the room that represent things prophets have taught us to do, such as attend church or be baptized. As a class, walk around the room, stopping at each picture or object to talk about how following the prophet’s teachings helps to keep us safe.



Following the prophet’s teachings helps to keep us safe.



Teach the Doctrine

Older Children

ACTS 23:10–11; 27:18–26; 28:1–6

When I face adversity, God does not forsake me.

Throughout the trials Paul experienced, the Lord was with him. How can you help the children liken Paul’s experiences to their own lives?

Possible Activities

- Using Acts 23:10, explain that Paul was put in prison because he taught the people about Jesus. Then read Acts 23:11 with the children. Or show the video “Be of Good Cheer” (LDS.org), which portrays this story. Why could Paul “be of good cheer” even though he was in prison?
- Write on the board *Acts 23:10–11*; *Acts 27:18–26*; and *Acts 28:1–6*. Show pictures of a jail, a ship, and a snake, and invite the children to review these verses and match them with the pictures. In each of these accounts, how did the Lord show Paul that He was with him?
- Invite someone from the ward to share an experience when the Lord was with him or her during a difficult time. Perhaps you or the children could also share experiences.

ACTS 26:1–29**I can boldly share my testimony of Jesus Christ.**

Paul's courage in sharing his testimony can help the children be bold when sharing their testimonies.

Possible Activities

- Invite the children to read Acts 26:1–29 and find some gospel truths that Paul taught to King Agrippa. Why might it have been scary for Paul to share these things before the king? Invite the children to list some gospel principles they know to be true. Ask them to think of someone they know who needs to hear their testimony of these truths.
- Invite the children to use this week's activity page to write something they might say in their testimony.

ACTS 27**Prophets warn me of danger.**

The children can listen to the messages of modern prophets and recognize their warnings. How can you help the children learn how to heed those warnings?

Possible Activities

- Cut a piece of paper shaped like a ship into puzzle pieces. Invite the children to write Paul's warnings in Acts 27:9–11 on the pieces and put the puzzle together. Why didn't the people listen to Paul? (see verse 11). Invite the children to read verses 18–20 and 40–44 to find out what happened as a result. (Explain that because the people followed Paul's later counsel to stay on the ship, no one died in the

shipwreck; see verses 30–32.) What can we learn from this experience about following the prophet?

- Bring a recent conference message by the President of the Church and share with the children any warnings or counsel he gave. Invite the children to think of ways they can follow the prophet.
- Show the video "Blessed and Happy Are Those Who Keep the Commandments of God" (LDS.org). How are prophets like the man with the binoculars?
- Write down a few activities the children can do that will help them learn about the role of a prophet—for example, "Read Doctrine and Covenants 21:4–7" or "Sing 'Follow the Prophet'" (*Children's Songbook*, 110–11, or use another song about prophets). Hang the list of activities outside the classroom, and invite one child to stand at the door and read one activity at a time to the rest of the children, allowing them to complete the activity before reading another one. Explain that just as one child has given direction to the others, a prophet teaches us what God would like us to do. Ask the children to share what they learned about prophets from the activities.

**Encourage Learning at Home**

Ask the children to use what they learned about Paul to encourage their families to study the prophet's most recent message and discuss how they can follow his counsel.

Improving Our Teaching

Involve the senses. "Most children (and adults) learn best when multiple senses are involved. Find ways to help the children use their senses of sight, hearing, and touch as they learn. In some situations, you may even find ways to include their senses of smell and taste!" (*Teaching in the Savior's Way*, 25).

I can boldly share my testimony of Jesus Christ (Acts 26:1-29).

Paul shared his testimony with King Agrippa. Write or draw your testimony in the box.

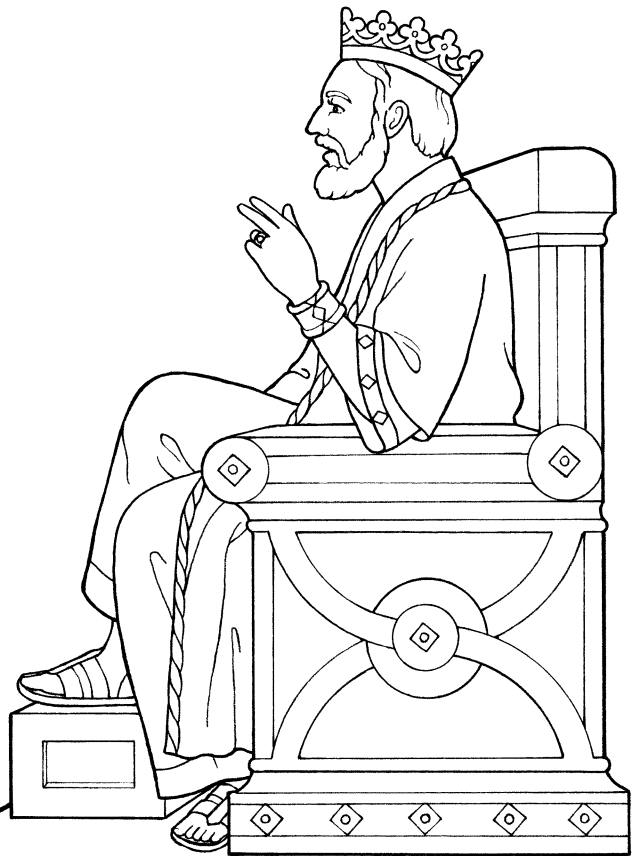



AUGUST 5-11

Romans 1–6

“The Power of God unto Salvation”

What promptings do you receive as you read Romans 1–6? These promptings could help you select from the following teaching ideas.

RECORD YOUR IMPRESSIONS _____



Invite Sharing

Invite the children to share what they did in response to any invitations you gave them in last week’s lesson. For example, did they talk to their families about the shipwreck described in Acts 27 and about following the prophet?



Teach the Doctrine Younger Children

ROMANS 1:16-17

I can show my faith in Jesus Christ by following Him.

Paul taught that the gospel has the power to bring salvation to everyone who lives by faith in Jesus Christ. How can you help the children show their faith in Jesus Christ by following Him?

Possible Activities

- Help the children find Rome on a map. Explain that the book of Romans contains a letter that Paul

wrote to Saints in Rome to help them understand gospel principles such as faith.

- Read Romans 1:17 to the children, and help them memorize the phrase “The just shall live by faith.” You could assign each child one word in the phrase and ask them to say that word when you point to them. Explain that this phrase means that we should live each day with faith in Jesus Christ. Do the children know what faith is? Show a picture of Jesus Christ and explain that we believe He is real even though we haven’t seen Him. This is faith—believing in something even though we haven’t seen it.
- Explain that we show our faith in Jesus Christ by obeying Him. Hide pictures around the room of people doing what Jesus has asked us to do. Let the children take turns finding and describing the pictures. What can we do to follow Jesus?
- Blindfold one of the children, and guide him or her across the room toward a picture of Jesus. Let each child have a turn. Help the children understand that they should follow Jesus’s teachings just as they followed your guidance.

ROMANS 6:1-11**Being baptized is like becoming a new person.**

The children you teach are preparing for baptism. What can they learn about baptism from Paul's instruction to "walk in newness of life"?

Possible Activities

- Invite the children to repeat the phrase "Walk in newness of life" (Romans 6:4). Explain that when we are baptized, we are forgiven of our sins. We have the chance to go forward by making good choices, repenting when we make mistakes, and striving to become more like Jesus. Use this week's activity page to teach the children that baptism helps us become a new person.
- Tell the children how you felt when you were baptized, and invite them to share experiences when they have attended a baptism. Invite them to draw pictures of themselves on their future baptism day and share what they can do to prepare for their baptisms.
- Sing with the children a song about baptism, such as "When I Am Baptized" (*Children's Songbook*, 103). What do we learn about baptism from this song?

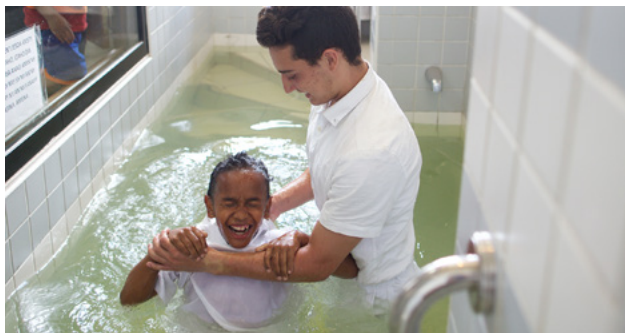

Baptism symbolizes beginning a new life as a disciple of Christ.



Teach the Doctrine

Older Children

ROMANS 1:16-17**I can show my faith in Jesus Christ by following Him.**

Paul taught that the gospel has the power to bring salvation to everyone who lives by faith in Jesus Christ. Faith is the first principle of the gospel. It motivates us to obey the commandments. How can you help the children better understand faith?

Possible Activities

- Ask a child to find Rome on a map. Help the children understand that over the next few weeks, they will learn from letters Paul wrote to Church members in various places, beginning with his letter to the Romans.
- Write the text from Romans 1:16 on the board, replacing a few words with blanks. Ask the children to look up the scripture and fill in the blanks. Point out the phrase "I am not ashamed of the gospel of Christ," and invite children to share what this phrase means to them.
- Invite a child to read aloud Romans 1:17, and ask the other children to listen for a word that is repeated. What does it mean to "live by faith"? Help the children find a definition of faith in a resource such as *Guide to the Scriptures*, "Faith," scriptures.lds.org. How would our lives be different if we did not have faith in Jesus Christ?
- Show the children a plant and a seed, and ask how we help a seed become a plant. Explain that when we plant and water a seed, we are showing that we have faith that it will grow. How do we show that we have faith in Jesus Christ? Consider singing "Faith" (*Children's Songbook*, 96) as part of this activity.

ROMANS 3:23-24**We all need Jesus Christ in order to be forgiven of our sins.**

Paul wanted the Romans to understand that salvation comes only through Jesus Christ and His grace. Ponder how you can teach this truth to the children.

Possible Activities

- Invite one of the children to read Romans 3:23-24. What do the children think these verses are teaching us? Explain that “grace” in verse 24 means the Savior’s gift of love and mercy, which makes it possible for us to receive forgiveness for our sins.
- Hang a treat or picture high on a wall or in another place that the children cannot reach by themselves. Let them try to reach it, and compare this to what Paul teaches in Romans 3:23. Then help them reach it. What has the Savior done for us that we cannot do for ourselves? Invite the children to share how they feel about the Savior when they think about what He has done for them.

ROMANS 6:1-11**Being baptized is like becoming a new person.**

Paul taught that baptism symbolizes the death and Resurrection of Christ. It also symbolizes the “death” of our sinful selves and being raised up to “walk in newness of life” (Romans 6:4). We renew our commitment

to walk in newness of life every time we partake of the sacrament.

Possible Activities

- Invite a child to read Romans 6:3-6. What did Paul say baptism is “in the likeness of”?
- Discuss how baptism symbolizes death and resurrection. Consider showing the video “The Baptism of Jesus” (LDS.org). Why are death and resurrection good symbols of what happens when we are baptized?
- Read together the sacrament prayers (see D&C 20:77, 79). Remind the children that when we take the sacrament, we renew the commitment we made when we were baptized to follow Jesus Christ. How does the sacrament help us “walk in newness of life”?
- Invite the children to make posters that show what it means to them to “walk in newness of life.” The children could hang these in their rooms to help them remember to make good choices.

**Encourage Learning at Home**

Encourage the children to ask family members to let them know when they see the children doing something that shows faith.

Improving Our Teaching

Build the children’s confidence. To help children build confidence that they can learn the gospel on their own, praise them when they participate in class.

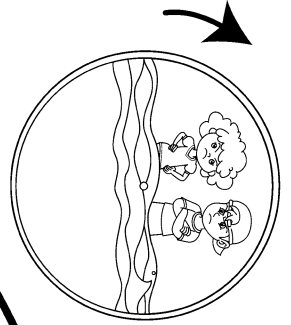

Being baptized is like becoming a new person (Romans 6:1-11).

Color and cut out the pictures below. Attach the water piece to the circle piece at the small center dot.
Rotate the circle to show how we become new people when we are baptized.

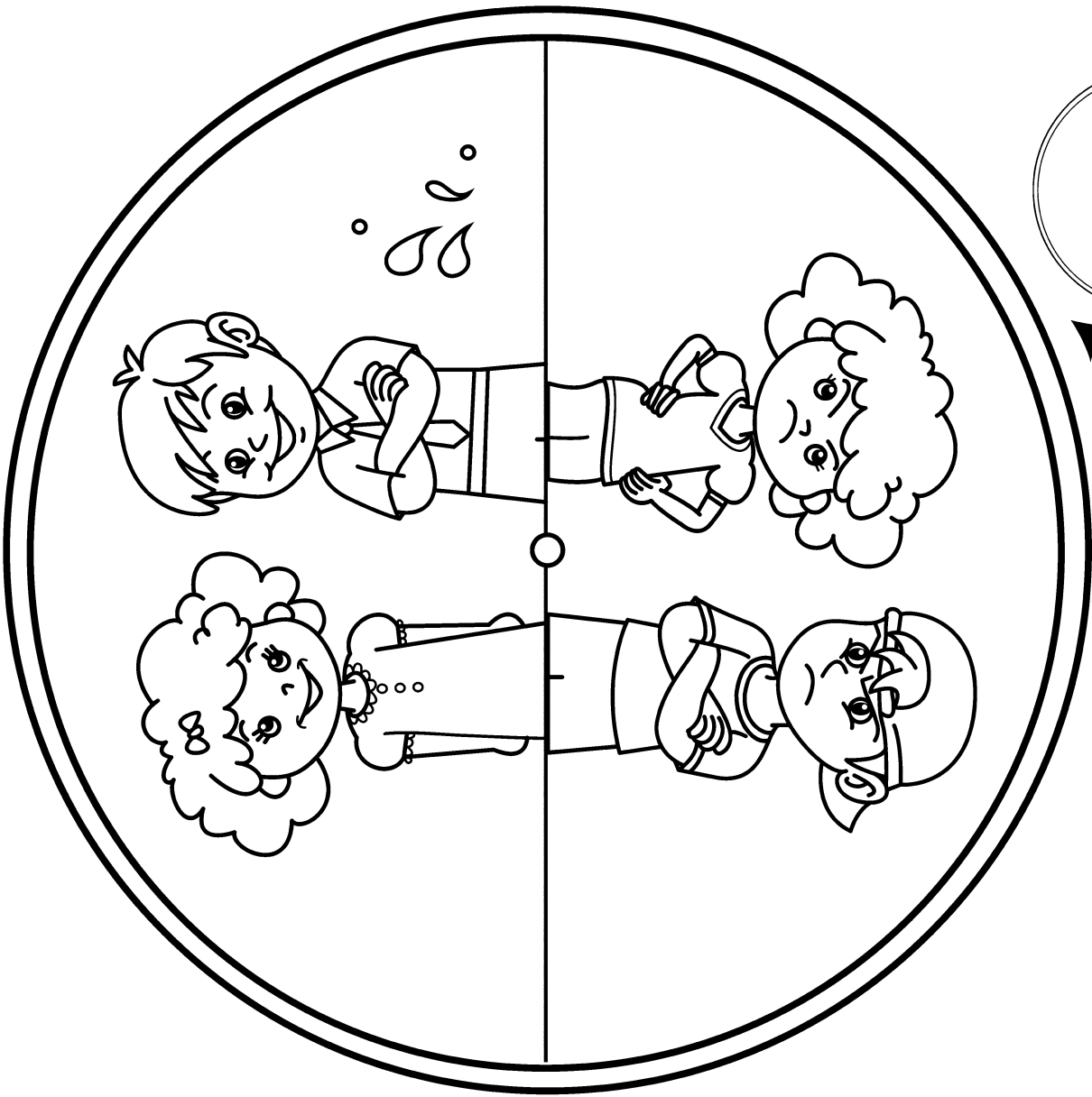

**Being baptized is like becoming a new person.
(Romans 6:1-11)**



AUGUST 12-18

Romans 7–16

“Overcome Evil with Good”

As you read Romans 7–16, record any impressions you receive about how you can teach the children the truths in these chapters.

RECORD YOUR IMPRESSIONS _____



Invite Sharing

Ask the children if they shared with their families something they learned in Primary last week. (You may need to briefly review last week's lesson.) If so, what did they share?



Teach the Doctrine Younger Children

ROMANS 8:35-39

My Heavenly Father loves me.

How can you use Paul's words to teach the children that Heavenly Father will always love them?



Let the Children Come, by Liz Lemon Swindle

Possible Activities

- Help the children memorize the phrase “[Nothing can] separate us from the love of God” (Romans 8:39). To illustrate this truth, nail two boards together, and label one “us” and the other “the love of God.” Let the children see if they can separate the boards.
- Take the children outside to feel the sunshine, or show a picture of the sun. How is the sun like Heavenly Father's love? Help them see that although the sun is far away, it can help us feel warm. We can feel Heavenly Father's love all the time, even though He is not physically with us. You

could also sing together “My Heavenly Father Loves Me” (*Children’s Songbook*, 228–29).

ROMANS 10:17

Faith comes by hearing the word of God.

As children hear the word of God and listen carefully to it, their faith in God will grow. How can you help them understand the importance of listening to God’s word?

Possible Activities

- Read Romans 10:17 to the children, and show them pictures of situations in which they can hear the word of God (like family scripture study, church, or general conference; see this week’s activity page). Ask the children when they have heard God’s word.
- Tell a story about a child who listens to the word of God in various ways. While you are telling the story, blow up a balloon little by little to represent how the child’s faith grows each time he or she hears the word of God.
- To help the children understand that their faith can grow, help them sing “Faith” (*Children’s Songbook*, 96–97). As they sing, ask them to pretend to be seeds by crouching down. Every time they sing the word *faith*, have them rise up a little like a growing plant.
- Hide in the classroom a set of scriptures, a picture of the President of the Church, and a copy of the *Friend* or *Liahona* magazine. Ask the children to find these things and share how each makes it possible for us to hear God’s word.

ROMANS 16:1–4

I can say thank you to those who help me.

Paul was grateful for the people who helped him. You can help the children notice the kind things others do for them and remember to thank them.

Possible Activities

- Explain that Paul was thankful for the help he received from a woman named Phebe and a married couple named Priscilla and Aquila (see Romans 16:1–4). Ask the children to draw pictures of Paul and these three people as you share words and phrases from the verses.
- Invite each child to share something nice that someone did for him or her recently. Help the children make thank-you cards for those people.
- Help the children learn how to say thank you in different languages. The song “Children All Over the World” (*Children’s Songbook*, 16–17) can help.



Teach the Doctrine Older Children

ROMANS 8:16–18

Heavenly Father wants me to prepare to receive all that He has.

Heavenly Father’s plan makes it possible for us to become like Him and inherit all that He has. This truth can inspire the children you teach to live the gospel more faithfully.

Possible Activities

- Read together Romans 8:16–18. What do we learn from these verses about who we are and who we can become? Explain that an “heir” is someone who inherits, or receives, what his or her parents have. Write on the board *What do we need to do to inherit all that our Father in Heaven has?* Sing together a song about obedience, such as “I Will Follow God’s Plan for Me” (*Children’s Songbook*, 164–65), looking for answers. What other answers can the children think of?
- Ask the children to think about a king who wants his sons and daughters to rule in his kingdom someday. Explain that Heavenly Father is like a

king, and we are His royal sons and daughters. You could share the story of the son of King Louis XVI of France, found in Sister Elaine S. Dalton's talk "Remember Who You Are!" (*Ensign* or *Liahona*, May 2010, 121). How can remembering that we are children of Heavenly Father and born to someday be like Him help us live righteously here on earth? (For further information, see *True to the Faith*, 74-76.)

ROMANS 10:17

Faith comes by hearing the word of God.

Children have many opportunities to hear the word of God. Help them see how hearing God's word can strengthen their faith.

Possible Activities

- Write the following sentence on the board:

_____ cometh
by _____
and _____ by
the _____
of _____.

Ask the children to fill in the blanks after reading Romans 10:17. Share a time when someone taught a gospel truth that helped to strengthen your faith—perhaps you could share a favorite scripture or quotation from general conference. Invite the children to share their own experiences.

- Label several glasses of water with things where we find the word of God (like the scriptures, church meetings, and general conference). Discuss how the word of God increases our faith as you pour each glass into a container labeled "Faith."

- Give one child a picture of the Savior healing someone without letting the other children see the picture. Ask the child to give clues to help the other children guess what the picture shows. How can we share with others what we know about the Savior so they can have faith in Him?

ROMANS 14:10, 13

"Let us not . . . judge one another."

When children interact with others who make different choices than they do, they may be tempted to be judgmental. Consider how Paul's counsel to the Romans can help them avoid such judgment.

Possible Activities

- Invite a child to read Romans 14:10, 13. Ask the other children to count how many times Paul used the word *judge*. What does it mean to judge someone? Why should we avoid judging others?
- Show a picture of someone, and ask the children what we know about this person only by looking at the picture. What are some things we don't know about him or her? Why is the Lord the best one to judge this person? (see 1 Samuel 16:7).



Encourage Learning at Home

Ask the children to pick one activity you did as a class and do it with their families. Tell them that next week they can share what they did.

Improving Our Teaching

Engage children in gospel discussions. You may need to think of creative ways to engage younger children in gospel discussions. Sometimes you can do something as simple as inviting the children to sit in a circle on the floor rather than on their chairs.

Faith comes by hearing the word of God (Romans 10:17).

Color and cut out the pictures and the envelope.

Fold the envelope on the dotted line, and tape or staple the short sides together.

Insert the pictures of ways we hear the word of God into the envelope.

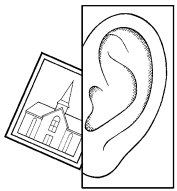
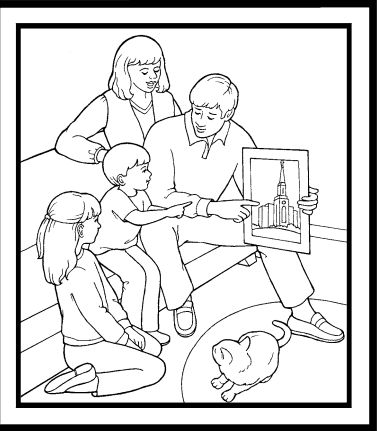
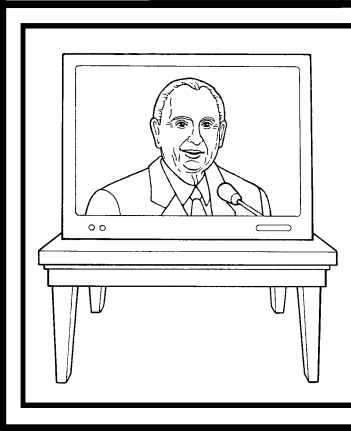
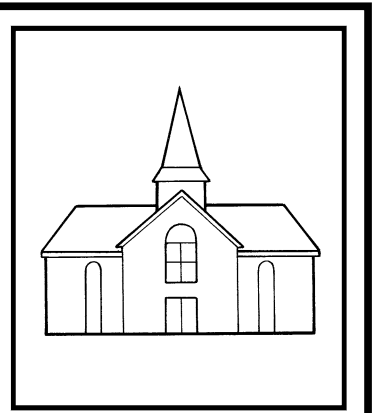
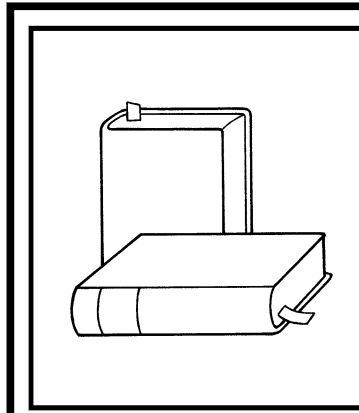



Corinth, Southern Greece, the Forum and Civic Center, painting by Balage Balogh

AUGUST 19-25

1 Corinthians 1-7

“Be Perfectly Joined Together”

The Holy Ghost will help you know what gospel principles in 1 Corinthians 1-7 will help the children you teach. As you prayerfully read these chapters, record the thoughts and feelings that come to you from the Spirit.

RECORD YOUR IMPRESSIONS _____



Invite Sharing

A few days in advance, invite one or more of the children to find a verse in 1 Corinthians 1-7 that they can share with the class. You could invite their parents to help if necessary.



Teach the Doctrine

Younger Children

1 CORINTHIANS 2:11-14

The Holy Ghost teaches me gospel truths.

One of the Holy Ghost’s roles is to teach us truth. What experiences can you share with the children to help them understand this?

Possible Activities

- Show objects or pictures that represent ways we learn about the world (such as a school, book, or

cell phone). What can we learn when we use these things? Explain that in 1 Corinthians 2:11, 14, Paul taught that we can learn about God only through the Spirit of God, which is the Holy Ghost. What can we do to learn “the things of God”?

- Clap your hands as you say each syllable in the sentence “The Holy Ghost teaches us truth.” Ask the children to clap their hands and repeat the phrase. Share with the children an experience when the Holy Ghost helped you know that something was true.
- Sing together a song about the Holy Ghost, such as “The Holy Ghost” (*Children’s Songbook*, 105). Help the children find words and phrases in the song that teach how the Holy Ghost speaks to us and what He teaches us.

1 CORINTHIANS 3:10-11

Jesus Christ is my foundation.

Children are laying a foundation for their testimonies, and you can help them build a solid foundation on Jesus Christ.

Possible Activities

- Read 1 Corinthians 3:11 to the children, and explain that Jesus Christ is our foundation. Show the children several pictures of things we can have testimonies of, including a picture of Jesus Christ. Help them arrange the pictures so that the picture of Jesus is on the bottom, like a foundation, and the other pictures “build” on a testimony of Him.
- Create actions for the song “The Wise Man and the Foolish Man” (*Children’s Songbook*, 281), and sing the song with the children. Give each child a rock with “Jesus Christ is my foundation” written on it. Let them take the rocks home to remind them what they learned.
- Share pictures that depict some of your favorite stories from the Savior’s life, and ask the children to tell you what is happening in the pictures. Let them share some of their favorite stories about Jesus. Bear your testimony that Jesus Christ is the foundation of your faith.

1 CORINTHIANS 6:19

My body is like a temple.

How can you help the children appreciate their bodies as gifts from God and have a greater desire to take care of them?

Possible Activities

- Show the children pictures of temples (see this week’s outline in *Come, Follow Me—For Individuals and Families*), and read these words from 1 Corinthians 6:19: “Your body is the temple of the Holy Ghost.” Help the children understand that Heavenly Father wants us to keep our bodies clean and holy, like a temple.
- Display a picture of a child, and put pictures around it of things that are good for our bodies and things that are bad. Invite the children to take

turns identifying the good things and removing the bad ones.

- Sing together a song about bodies, such as “Head, Shoulders, Knees, and Toes” (*Children’s Songbook*, 275), and ask the children why they are thankful for their bodies.



Teach the Doctrine

Older Children

1 CORINTHIANS 1:23–25

God is wiser than man, and I show true wisdom when I believe His teachings.

The children you teach will find—if they haven’t already—that some people teach things that contradict God’s wisdom. Studying 1 Corinthians 1:23–25 can help the children understand that God is wiser than man.

Possible Activities

- Read 1 Corinthians 1:23–25 together, and help the children find the words *wisdom* and *foolishness*. Explain that many people thought Paul’s teachings were foolish, but Paul explained that believing Christ’s gospel is true wisdom. Why is it wise to believe what God teaches?
- Help the children role-play how they could respond to people who think Church teachings are “foolish”—teachings such as believing in the Savior, keeping the Word of Wisdom, or obeying the law of tithing. For example, they could testify of the blessings that come from living these teachings.
- Share an experience when others thought that your beliefs were foolish, or share an example from the scriptures. Could the children share similar experiences? How can 1 Corinthians 1:25 help us remain faithful when others call our beliefs foolish?

1 CORINTHIANS 2:11-14**The Holy Ghost teaches me gospel truths.**

How can you help the children recognize that they need the Holy Ghost to understand “the things of God”?

Possible Activities

- Make a list of ways we learn about the world—for example, books, school, and the internet. Then read together 1 Corinthians 2:11–14. What do these verses teach about how we learn “the things of God”?
- Invite the children to share a time when they felt the promptings of the Holy Ghost, also called “the Spirit of God” (1 Corinthians 2:11–14). Such times could include when they were at church, praying, or reading the scriptures. Help them understand that the Holy Ghost was teaching them truth, as Paul described.
- Invite each child to read one of these scriptures: 1 Corinthians 2:11–14; 1 Nephi 10:17; Moroni 10:3–5; and Doctrine and Covenants 8:2–3. Ask the children to share what they learned from these scriptures about how the Holy Ghost teaches us. Encourage them to write these references in the margins of their scriptures.

1 CORINTHIANS 6:19-20**I should treat my body with respect and keep it holy.**

Understanding that our bodies are gifts from Heavenly Father will help the children keep their bodies sacred, even when they are tempted to do otherwise.

Possible Activities

- Bring a wrapped gift with pictures of a child and a temple inside. Invite the children to read 1 Corinthians 6:19–20 and guess what is in the gift. Let them unwrap the gift and discuss how our bodies are like temples.
- Talk with the children about how we should treat a temple. If our bodies are like temples, how should we treat our bodies? Singing or reading the words to a song about temples, such as “The Lord Gave Me a Temple” (*Children’s Songbook*, 153), can help answer this question. When we make mistakes, how can we make our “temples” clean again?
- Read together the section titled “Physical and Emotional Health” in *For the Strength of Youth* (2011, 25–27). Invite the children to list on the board the counsel they find about how to care for our bodies.

**Encourage Learning at Home**

Invite the children to share with their families a song that they sang in class and what they learned from it.

Improving Our Teaching

Testify of Jesus Christ. One of the most important things you can do as a teacher is to testify of Jesus Christ. This will help the children strengthen their testimonies and feel the Savior’s love for them.

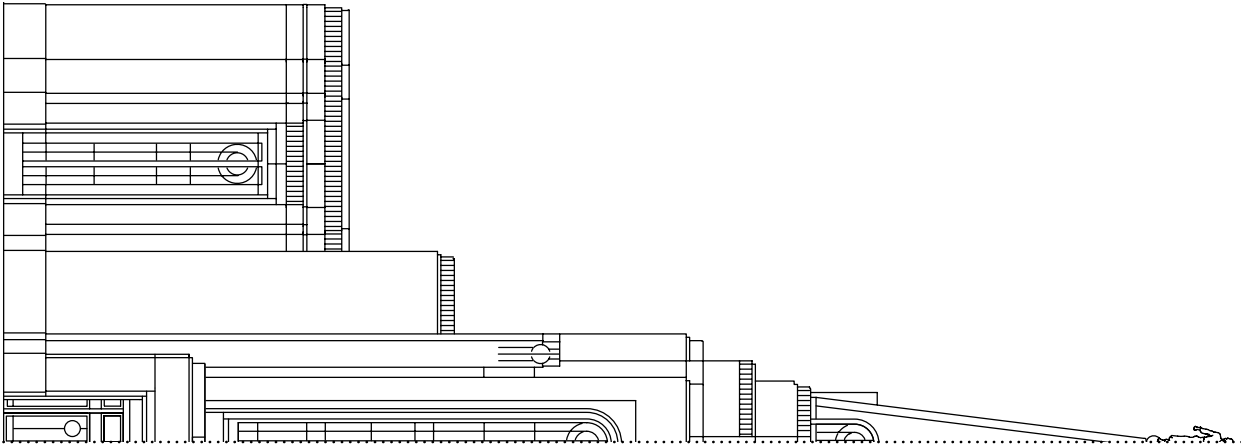

**My body is like a temple
(1 Corinthians 6:19).**
Draw a picture of your body
in the space below.
Fold the picture on the dotted
lines to show how your body
is like a temple.

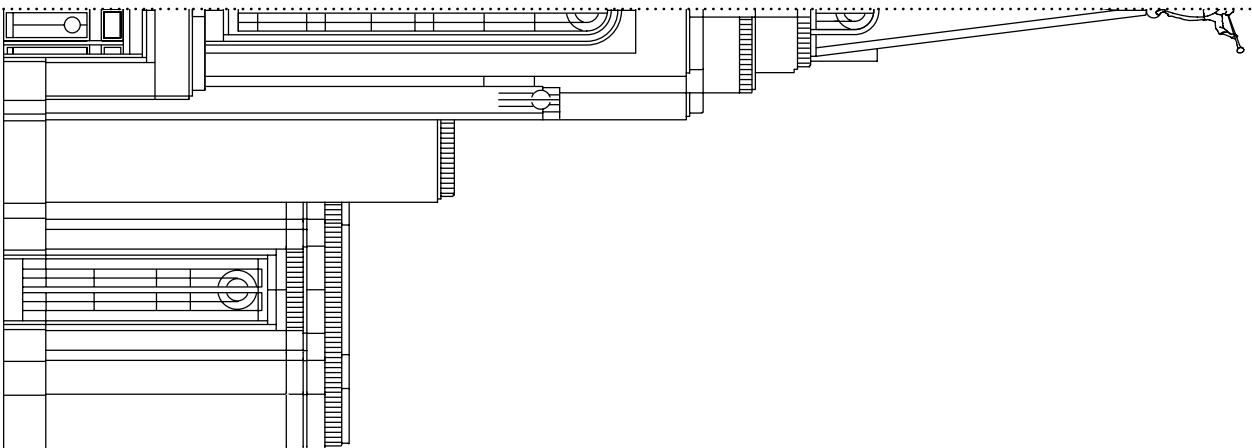
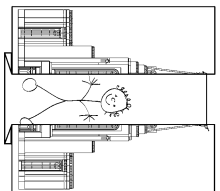



AUGUST 26–SEPTEMBER 1

1 Corinthians 8–13

“Ye Are the Body of Christ”

As you read 1 Corinthians 8–13, listen for promptings from the Spirit about how to teach the principles in these chapters. Remember that any of the activity ideas can be adapted for both older and younger children.

RECORD YOUR IMPRESSIONS _____



Invite Sharing

Invite the children to share something they did during sacrament meeting today to think about Jesus.



Teach the Doctrine Younger Children

1 CORINTHIANS 10:13

Heavenly Father will help me make righteous choices.

It's not always easy to choose the right, but Heavenly Father will help us make righteous choices.

Possible Activities

- Read 1 Corinthians 10:13 to the children, inviting them to turn away from you when they hear the words “tempted” or “temptation.”

- Create small stop signs for the children. Tell some brief stories of people who are about to make a wrong choice. As the children listen, invite them to hold up their signs when the person in the story makes a wrong choice. What would be the right choice? Testify that Heavenly Father will help them choose the right.
- Show a picture of Jesus, and sing with the children a song about Jesus Christ, such as “I’m Trying to Be like Jesus” (*Children’s Songbook*, 78–79). How does remembering Jesus help us make good choices? Show pictures of other things that help us make good choices, such as parents or scriptures. Ask the children what helps them make good choices.

1 CORINTHIANS 12:4, 7–11

Heavenly Father has blessed me with spiritual gifts.

Heavenly Father has given all His children spiritual gifts. What spiritual gifts do you see in the children you teach?

Possible Activities

- Read together 1 Corinthians 12:7–11, and identify the spiritual gifts Paul named. Help the children think of actions that could go with these gifts of the Spirit, and use the actions to help the children remember the gifts.
- Ask the children to draw a picture of a favorite gift they have received. Explain that Heavenly Father gives us spiritual gifts to strengthen our faith and help us bless others.
- Write a note for each child, describing a spiritual gift you have seen in him or her (or you could invite parents to write these notes). Wrap the notes like gifts. Allow the children to open their gifts, and help them read about their spiritual gifts.



Heavenly Father has given all His children spiritual gifts.

1 CORINTHIANS 13:1–8

I can love others.

The scriptures teach that charity is the “pure love of Christ” (Moroni 7:47). How can you help the children develop and express Christlike love?

Possible Activities

- Read 1 Corinthians 13:8 and Moroni 7:47, and help the children repeat the phrase “Charity is the pure love of Christ.” Show pictures of Jesus being loving and kind, and ask the children how He showed love to others (see *Gospel Art Book* for ideas).

- Choose a child to stand in the front of the room. Ask the child how he or she would serve another person in the class. Explain that this is one way we can show charity to others. Invite other children to take turns showing charity.
- Sing a song about loving others, such as “Jesus Said Love Everyone” or “Love One Another” (*Children’s Songbook*, 61, 136), with the children. Show pictures of different people (such as a parent, teacher, or friend), and ask the children to share how they could serve that person. Invite the children to think of someone they could serve and write a note or draw a picture to give that person. If they need other ideas, show the video “Pass It On” (LDS.org).



Teach the Doctrine

Older Children

1 CORINTHIANS 10:13

Heavenly Father will help me resist temptation.

The promises in this verse can give children confidence that Heavenly Father will help them when they are tempted.

Possible Activities

- Invite the children to read 1 Corinthians 10:13 in pairs and summarize the verse in their own words. Ask the children to share an experience in which Heavenly Father helped them avoid or resist temptation. What can we do to rely on Heavenly Father when we are tempted?
- Write on slips of paper temptations children may face today. Invite the children to each choose a paper and share what Heavenly Father has given to help us avoid or resist these temptations. For some ideas, read together Alma 13:28–29.

1 CORINTHIANS 11:23-29**During the sacrament, I can think about how I am following the Savior.**

The sacrament has additional significance for children who have been baptized. Help them see this sacred ordinance as an opportunity to “examine” themselves and renew their commitment to the Savior (1 Corinthians 11:28).

Possible Activities

- Ask a child to read 1 Corinthians 11:28. What does it mean to “examine” ourselves before taking the sacrament? Ask the children to think of other people who examine things, like doctors, detectives, or scientists (for example, doctors examine our bodies for wounds or diseases that need to be healed). What does their work teach us about how we should examine ourselves when we partake of the sacrament?
- Ask the children to make a list of things they can think about when they partake of the sacrament. Invite them to use their lists as a reminder to examine themselves during the sacrament.

1 CORINTHIANS 12:4, 7-12, 31; 13:1-8**I have spiritual gifts.**

Paul taught that gifts of the spirit are “given to every man” (1 Corinthians 12:7). This principle can help the children build their sense of self-worth, especially as they use their gifts to bless others.

Possible Activities

- Ask the children to write on the board the spiritual gifts they find in 1 Corinthians 12:7-11; 13:2. Invite them to find any additional gifts mentioned in Moroni 10:8-18 and Doctrine and Covenants 46:13-26. Share with them some additional spiritual gifts mentioned by Elder Marvin J. Ashton: “The gift of asking; the gift of listening; . . . the gift of avoiding contention; . . . the gift of seeking that which is righteous; the gift of not passing judgment; the gift of looking to God for guidance; . . . the gift of caring for others; . . . the gift of offering prayer; the gift of bearing a mighty testimony” (“There Are Many Gifts,” *Ensign*, Nov. 1987, 20). Invite the children to talk about the spiritual gifts they see in each other.
- Before class, ask the parents about the gifts they see in their children, or think about their gifts yourself. Tell the children about these gifts, and ask them to guess which child has that gift. Invite the children to write down one way they will use their gift to bless someone this week.
- Share different situations in which people could use a spiritual gift from 1 Corinthians 12:7-10. Invite the children to identify the spiritual gifts that could be used in each situation.

**Encourage Learning at Home**

Invite the children to share their spiritual gifts with their families and ask their family members what their gifts are.

Improving Our Teaching

Extend invitations that respect agency. As you invite children to act on what they are learning, think of ways to honor their agency. Rather than extending specific invitations, consider inviting them to think of their own ways to apply what they have learned.

I can love others (1 Corinthians 13:1-8).

Choose three different colors. Color all shapes containing a circle one color, all shapes containing a square another color, and all shapes containing a triangle a third color.

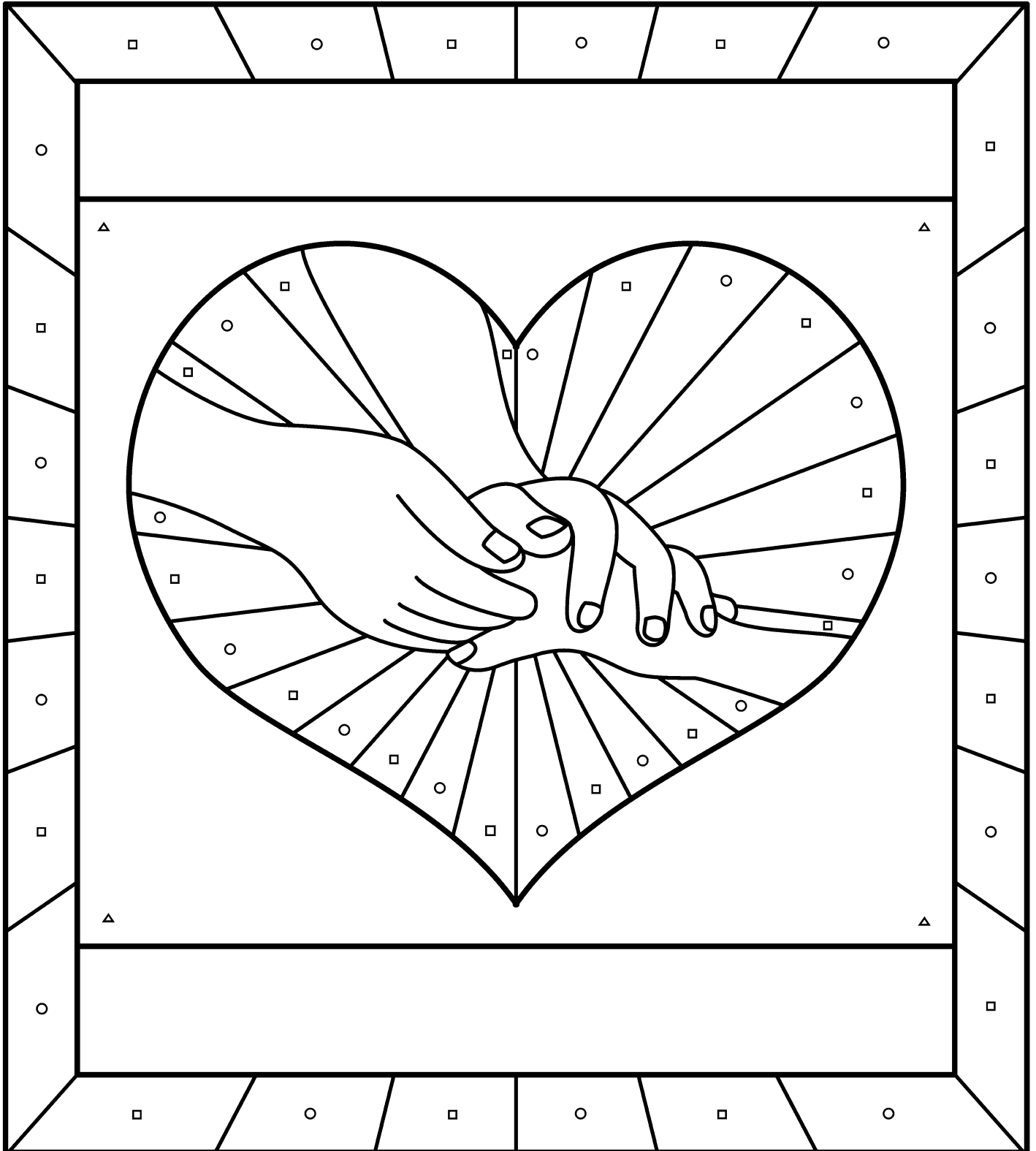



SEPTEMBER 2-8

1 Corinthians 14–16

“God Is Not the Author of Confusion, but of Peace”

As you read 1 Corinthians 14–16, the Holy Ghost will help you know what to teach the children in your class. Review this outline for additional ideas.

RECORD YOUR IMPRESSIONS _____



Invite Sharing

You might start this week’s lesson by reading 1 Corinthians 14:26 aloud. Point out that when we come together at church, we can edify (or build up and help) others when we share. What can the children share to edify someone in class today?



Teach the Doctrine Younger Children

1 CORINTHIANS 15:12-22

I can live with Heavenly Father after I die because Jesus Christ was resurrected.

How can you teach the children in your class that because Jesus Christ was resurrected we can live again?

Possible Activities

- Repeat the following phrase several times with the children: “In Christ shall all be made alive” (1 Corinthians 15:22). Show a picture of the resurrected Savior (see this week’s outline in *Come, Follow Me—For Individuals and Families*). Explain that we will all die someday, but because Jesus was resurrected, we will all come back to life after we die.
- Use an object lesson like this one to teach about the Resurrection: Show the children a jacket, which represents our physical bodies. When we are alive, our spirits are in our bodies, and our bodies can move (put the jacket on). When we die, our spirits leave our physical bodies, and our bodies cannot move (remove the jacket and lay it on a table or chair to represent a body without its spirit). When we are resurrected, our spirits return to our bodies (put the jacket on again), and they are never separated again. Let the children take turns putting the jacket on and taking it off while another child explains what happens when we are resurrected.

1 CORINTHIANS 15:29

I can be baptized for people who died.

The children you teach can prepare now to go to the temple and be baptized for the dead when they turn 12 years old. Paul mentions this important doctrine in his letter to the Corinthians.

Possible Activities

- Help the children think of things they cannot do for themselves (such as carrying something heavy or reaching something on a high shelf). Who helps them do these things? Show a picture of one of your ancestors who died without being baptized. Tell the children about this person, and explain that this person can't be baptized without help from someone on earth.
- Ask the children if they have any family members who have been to the temple to perform baptisms for the dead. Show pictures of a temple baptismal font. Do the children know what happens here? Explain that in the temple we can be baptized for people who have died without being baptized. Then those people can choose whether to accept the baptism.

1 CORINTHIANS 15:40-41

Heavenly Father wants me to live with Him in the celestial kingdom.

How can you teach the children about the celestial, terrestrial, and telestial kingdoms? These activities could help.

Possible Activities

- Write on the board *celestial*, *terrestrial*, and *telestial*. Help the children learn to say these terms.
- Show pictures of the sun, moon, and stars. Which shines the brightest? Read 1 Corinthians 15:40-41 to the children (see also Joseph Smith Translation, 1 Corinthians 15:40, footnote *a*). Explain that the sun, moon, and stars represent the kingdoms we

can live in after we are resurrected. In the celestial kingdom, we can live with Heavenly Father.

- Draw the sun on the board and place small pieces of paper, or steps, on the ground leading to the sun. Each paper could represent something we need to do to enter the celestial kingdom (see D&C 76:50-53). Allow the children to share ideas and take steps toward the celestial kingdom.



Paul compared celestial glory to the sun.



Teach the Doctrine
Older Children

1 CORINTHIANS 15:12-22

Because of Jesus Christ and His Resurrection, I will be resurrected.

Do the children you teach understand the importance of Jesus Christ's Resurrection? These ideas may help.

Possible Activities

- Invite the children to take turns reading verses in 1 Corinthians 15:12-22, looking for answers to the question "What would happen if there were no resurrection?"
- Invite the children to role-play how to explain resurrection to someone. For ideas, see Thomas S. Monson's message "Mrs. Patton—the Story Continues" (*Ensign* or *Liahona*, Nov. 2007, 21-24). See also the video "Until We Meet Again" (LDS.org). Bear your testimony of the Resurrection of Christ.

1 CORINTHIANS 15:12–13, 20–22, 29**I can prepare to go to the temple to be baptized for the dead.**

When the children turn 12, they can receive a temple recommend and perform baptisms for the dead in the temple. How can you help them prepare?

Possible Activities

- Read 1 Corinthians 15:29. What were the Saints in Paul's day doing that we also do today?
- Ask the children why we are baptized for the dead. If necessary, explain that many of our ancestors did not have the opportunity to be baptized and confirmed during this life. In the temple, we can be baptized and confirmed for them.
- A few days before class, ask a parent of one of the children to come prepared to share his or her family tree, or to tell a story about an ancestor. You could also share about your own ancestors.
- Invite a member of the bishopric to share some things the children can do to be worthy to enter the temple. Ask the children what they can do to remember to do these things. Write their ideas on the board. Invite them to make a goal to go to the temple someday.

1 CORINTHIANS 15:40–41**After I am resurrected, I can live in the celestial kingdom.**

To teach the Corinthians about the bodies we will receive in the Resurrection, Paul mentioned three degrees of glory: celestial, terrestrial, and telestial.

Possible Activities

- Read 1 Corinthians 15:40–41 and invite a child to draw a sun, moon, and star on the board. Ask class members to identify which kind of resurrected body is represented by each drawing.
- Sing together a song about temples, such as "The Lord Gave Me a Temple" (*Children's Songbook*, 153). What does this song teach us about preparing to live in celestial glory?
- Explain that Joseph Smith had a vision in which he saw three kingdoms that match the kinds of bodies Paul describes. Help the children find phrases from Doctrine and Covenants 76:50–53, 70; 76:71–79; 76:81–82 that describe these three kingdoms.



Encourage Learning at Home

Invite the children to ask their parents to tell them a story about one of their ancestors. They could share the story with the class next week.

Improving Our Teaching

Encourage children to ask questions. "Strive to see [the children's] questions as opportunities, not as distractions or impediments to your lesson. . . . Such questions give you valuable insights into what the children are thinking, what concerns they have, and how they are responding to the things they are learning. Help them see that the answers to their questions can be found in the scriptures and the words of living prophets" (*Teaching in the Savior's Way*, 25–26).

After I am resurrected, I can live in the Celestial Kingdom (1 Corinthians 15:40-41).

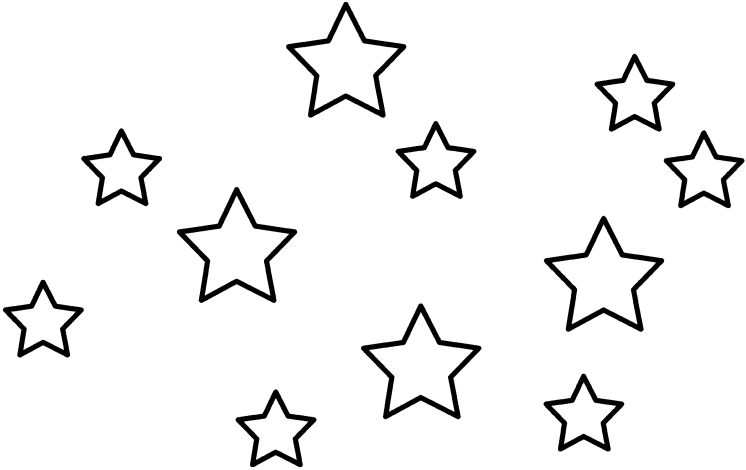
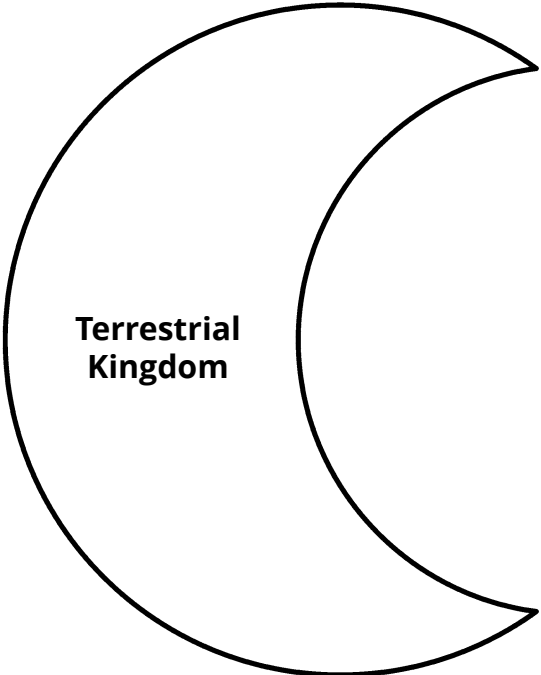
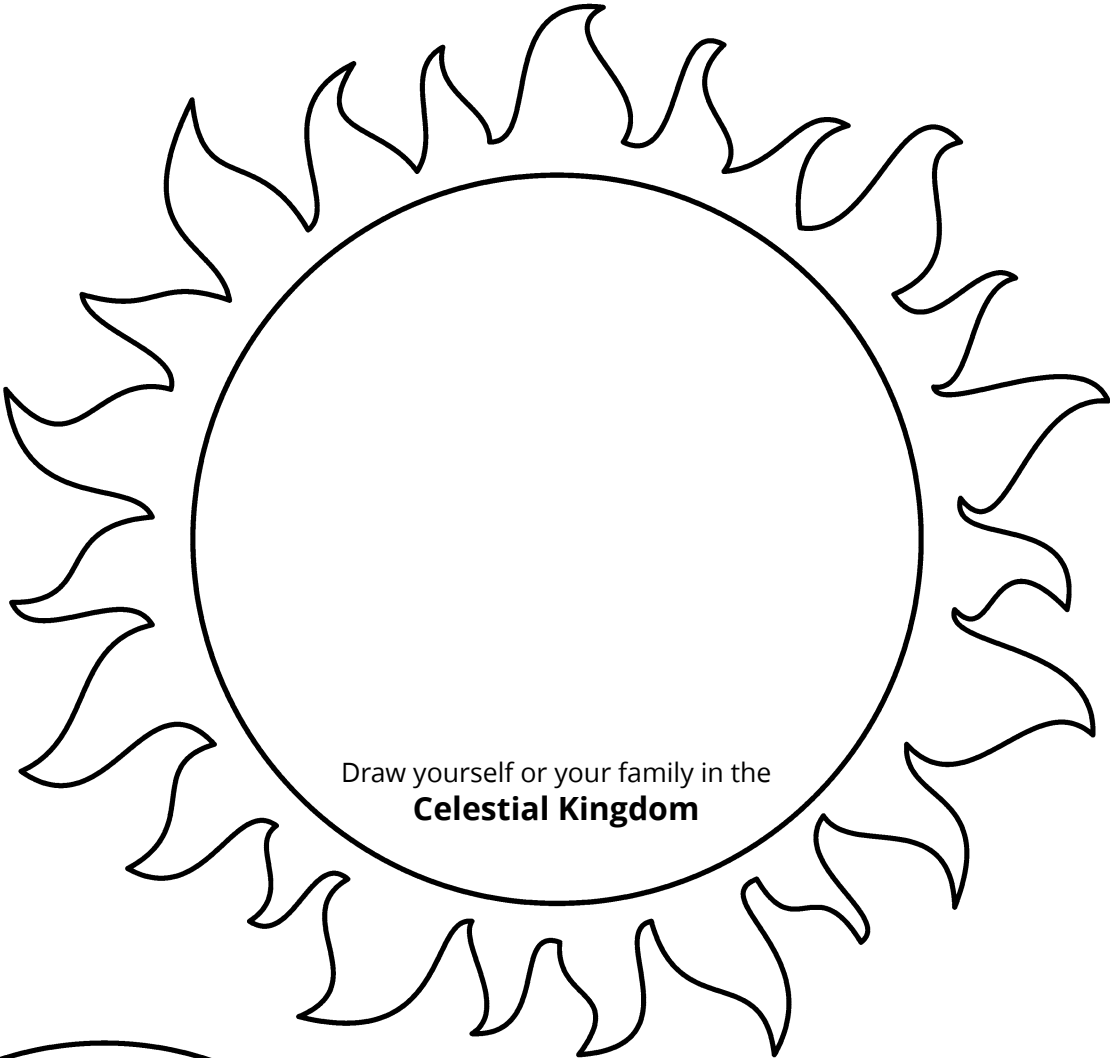

Telestial Kingdom



SEPTEMBER 9–15

2 Corinthians 1–7

“Be Ye Reconciled to God”

Begin your preparation by reading 2 Corinthians 1–7. *Come, Follow Me—For Individuals and Families* can help you understand these chapters, and this outline can give you teaching ideas.

RECORD YOUR IMPRESSIONS _____



Invite Sharing

Some of the children in your class may have written letters this week about how a family member is a good example of a disciple of Jesus Christ. If they did, ask them ahead of time to share a letter in class. Or ask the children to share something else they learned.



Teach the Doctrine

Younger Children

2 CORINTHIANS 1:3–4

Heavenly Father comforts me, and I can comfort others.

How can you give the children confidence that Heavenly Father will comfort them? How can you encourage them to comfort others?

Possible Activities

- Bring objects to class that provide comfort, such as a blanket or bandage. Ask the children what comforts them when they are sad or afraid or have other problems. Read 2 Corinthians 1:3–4 with the children, and explain that “tribulation” is another word for difficult problems. Share some ways in which Heavenly Father has comforted you, and testify that He will comfort the children as well.
- Show pictures of people being baptized (see *Gospel Art Book*, nos. 103 and 104) while you read 2 Corinthians 1:4 and Mosiah 18:8–9 to the children. Explain that at baptism we promise to comfort others. How can we follow Paul’s counsel to “comfort them which are in any trouble”?
- Invite the children to draw a picture of themselves helping someone in need. Let them explain how doing these things can bring comfort to others.

2 CORINTHIANS 2:7–8, 10**I can forgive others.**

Select from the following activities—or come up with your own—to help strengthen the children’s desire to forgive others.

Possible Activities

- Explain to the children that Paul wanted the Corinthian Saints to forgive a man who had sinned. Read 2 Corinthians 2:7–8, 10, and invite the children to place their hands over their hearts every time they hear the words *forgive* and *forgave*.
- Invite the children to role-play how they could respond in situations when someone has done something unkind. Let them take turns saying “I’m sorry” and “I forgive you.” How do we help people know that we forgive them? Explain that one way might be to “confirm your love,” or show love to them (2 Corinthians 2:8).

2 CORINTHIANS 4:1–2**I believe in being honest.**

Paul taught that servants of Christ do not lie to others—they have “renounced the hidden things of dishonesty.” Ponder ways you can strengthen the children’s desire to be honest in all things.

Possible Activities

- Help the children memorize the phrase “We believe in being honest” (Articles of Faith 1:13). Write this phrase on paper bracelets the children can decorate and wear home. Explain that being honest means telling the truth.
- Ask the children to raise their hands when you say something that is true and lower them when you say something that is not true. Make simple but obvious statements, such as “Today is Sunday” or “I have three noses.” Repeat the activity a few times, letting the children take turns being the one who makes true and false statements. Why is it good to be honest?



Teach the Doctrine

Older Children

2 CORINTHIANS 1:3–4**Heavenly Father comforts me, and I can comfort others.**

Remembering how God has comforted them can inspire the children to offer comfort to others.

Possible Activities

- As you read 2 Corinthians 1:3–4, ask the children to listen for an answer to the question “What does God do for us?” Help the children list ways in which God comforts us. Invite the children to share experiences when they were sad or worried or afraid and God comforted them.
- Invite the children to share ways in which we can comfort others. Give them time to think of someone they know who needs comfort and make a plan to reach out to that person.

2 CORINTHIANS 2:5–11**I can forgive others.**

It can be hard to forgive others when they are unkind to us. But the children you teach will experience love, peace, and happiness as they learn to forgive.

Possible Activities

- Tell the children that someone in Corinth had sinned and “caused grief” for the Saints (see 2 Corinthians 2:5). Ask the children to search 2 Corinthians 2:7–8 to find what Paul wanted the Saints to do.
- Share an experience when you forgave someone—or someone forgave you—and how you felt afterward.

2 CORINTHIANS 5:6-7**I “walk by faith, not by sight.”**

Consider how you can encourage the children to keep God’s commandments even when they do not see the blessings they desire right away.

Possible Activities

- Read 2 Corinthians 5:6–7 and Alma 32:21 with the children, and ask them to look for words and phrases that help to define faith. Ask them to write down their definitions, read them aloud, and place them on the board.
- Blindfold one of the children, and ask the other children to give directions to help him or her complete a task such as building a tower with blocks, putting together a puzzle, or walking across the room. How does this activity help us understand what it means to “walk by faith” in God?
- Show the video “Pure and Simple Faith” (LDS.org), and ask the children how the young woman walked by faith. Share an experience when you had to have faith in God. Invite the children to share any experiences they have had with walking by faith.

2 CORINTHIANS 7:8-11**Godly sorrow leads me to repent.**

It’s natural for children to feel ashamed or embarrassed when they are caught doing something wrong.

Help them distinguish these feelings from godly sorrow, which leads to true repentance.

Possible Activities

- Explain that in 2 Corinthians 7:8–11, Paul referred to a letter he had previously written to the Saints, boldly warning them about their sins. Read these verses together. Why was Paul glad that the Saints were sorrowful? Point out that this kind of sorrow is called godly sorrow.
- Ask the children to close their eyes and think about a time when they did something wrong and felt bad about it. Invite them to ask themselves, “Why did I feel bad?” Write on the board some reasons people feel bad after doing something wrong, such as “I was afraid I would be punished” or “I was ashamed of what people would think of me” or “I knew Heavenly Father was disappointed in me.” Which of the answers on the board seem like “godly sorrow”? Why is godly sorrow better than other kinds of sorrow we can feel after doing something wrong?



Encourage Learning at Home

Tell the children that they can share one of the activities from today’s class with their families at home, perhaps during a family home evening.

Improving Our Teaching

Display a scripture. Select a scripture verse that you find meaningful and display it in your classroom where the children will see it often. Perhaps the children could take turns selecting a scripture to display.

I believe in being honest (2 Corinthians 4:1-2).

Put the pictures in order by placing numbers in the small corner boxes.

Share the story with someone, and tell why it is important to be honest and to forgive others.

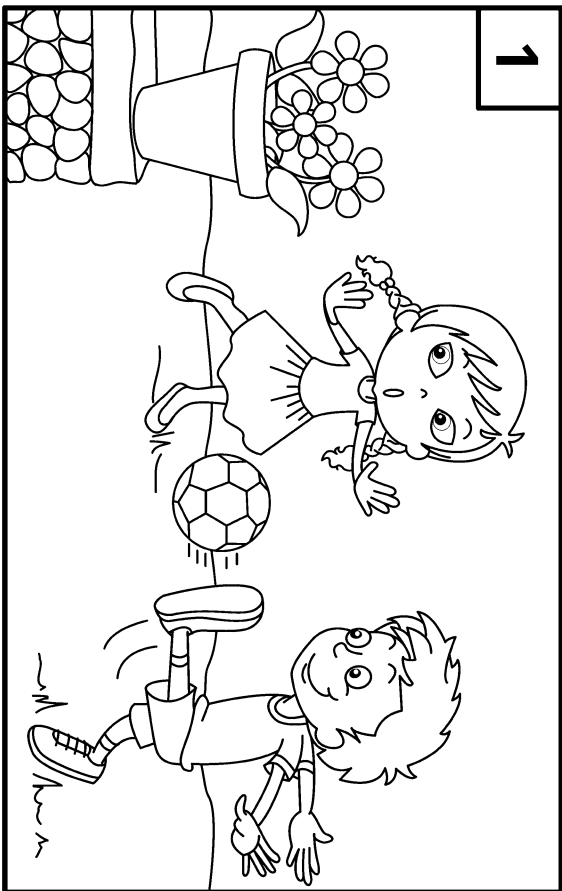



SEPTEMBER 16-22

2 Corinthians 8–13

“God Loveth a Cheerful Giver”

Your best ideas for teaching the children in your class will come as you prayerfully study 2 Corinthians 8–13 with them in mind. Additional teaching ideas can be found in this outline.

RECORD YOUR IMPRESSIONS _____



Invite Sharing

One good way to invite sharing among the children is to remind them of something you invited them to do during a previous lesson. Ask them to share their experiences.



Teach the Doctrine

Younger Children

2 CORINTHIANS 9:6-7

I can cheerfully give to people in need.

It is always good to serve others, but it is even better to serve cheerfully. Consider what will inspire each child to be “a cheerful giver.”

Possible Activities

- Invite the children to repeat the phrase “God loveth a cheerful giver” (2 Corinthians 9:7). What does it mean to be “a cheerful giver”? Show a picture of a happy face and a sad face, and ask the children which one looks like a cheerful giver.
- Sing together a song about service, such as “When We’re Helping” (*Children’s Songbook*, 198), several times. The first time, ask the children to sing cheerfully; then ask them to sing the song with different emotions or attitudes, such as sad, tired, angry, or scared. Remind the children that Heavenly Father wants us to help others gladly. Then sing the song cheerfully again.
- Give the children pictures of smiling faces. Ask them to hold up their pictures when they hear the words *smile* or *smiling* as they sing “Smiles” (*Children’s Songbook*, 267). They could do the same thing with pictures of frowning faces and the words *frown* and *frowning*. Tell the children that a frowning face is not cheerful; one way to be cheerful and serve others is to smile and help others smile.
- Plan a class activity to serve someone, such as a child who does not attend Primary or a ward member or neighbor in need. You might plan to

visit this person’s home, write kind notes or draw pictures, or make a treat to share.

- Invite each child to plan an act of cheerful service for a member of his or her family. During next week’s lesson, ask them to share what they did.

2 CORINTHIANS 12:7–10

Heavenly Father always answers prayers, but He doesn’t always give me everything I ask for.

Paul’s experience with praying for his “thorn in the flesh” to be removed teaches us that God sometimes shows His love for us by not giving us what we want.

Possible Activities

- Show the children a plant with thorns (or a picture of one). Help them imagine what it would feel like to have a thorn stuck in their skin for a long time. Summarize 2 Corinthians 12:7–10 for the children, using words they will understand. Explain that Paul’s “thorn in the flesh” was a trial, such as a physical weakness. Even though Paul asked God to remove the trial, God did not. Instead, God taught Paul that challenges can help us learn to be humble and trust Him. Then God can make us strong.
- Testify that Heavenly Father knows what is best for us, and He will give us what we need, even if it is different from what we think we need. You might also share an experience when your prayers were answered in a way or at a time that was different from what you expected. The story “Don’t Forget to Pray for Erik” (*Friend*, Jan. 2017, 36–37) can also help.
- Sing with the children a song about Heavenly Father’s love, such as “A Child’s Prayer” (*Children’s Songbook*, 12–13). Ask the children what they would say to someone who wonders whether Heavenly Father hears and answers prayers. Sing the song again, and point out lines that describe how Heavenly Father feels about us.



Teach the Doctrine

Older Children

2 CORINTHIANS 9:6–9

I can cheerfully give to people in need.

Paul wanted to inspire the Saints to give of their abundance to help the poor. How will you use his words to inspire the children to serve others?

Possible Activities

- Write the words of 2 Corinthians 9:7 on the board, with key words left blank. Invite the children to guess what the missing words are. Then let them read the verse in the scriptures to fill in the blanks. What does it mean to give “grudgingly, or of necessity”? What does it mean to be “a cheerful giver”?
- Invite the children to help you find pictures of the Savior serving others (there are several in *Come, Follow Me—For Individuals and Families*). Ask them what they see in these pictures that helps them know that Jesus served others with love. Set a goal as a class to say yes when family members or others ask us to serve in the coming week, such as by helping around the house or caring for others.
- Help the children decorate small stones. Invite them to carry their “service stones” in their pockets this week to help them remember to cheerfully serve others.
- Help the children come up with new verses to a song about service, such as “Fun to Do” (*Children’s Songbook*, 253), that teaches that it is fun to serve others in a variety of ways.

2 CORINTHIANS 12:7-10**Heavenly Father always answers prayers, but He doesn't always give me everything I ask for.**

Paul asked God to remove his weakness, but God knew that Paul's infirmity would humble him and make him strong.

Possible Activities

- Invite the children to compare 2 Corinthians 12:9-10 and Ether 12:27. What words or phrases are repeated? What are these verses teaching? (You may need to explain that Paul was comparing his challenge to a thorn in his skin.) What did God teach Paul about trials?
- Invite the children to list some trials people have in life. Help them consider how someone might learn from these trials and be blessed by them.

- Read with the children "Will Heavenly Father Always Answer My Prayers?" (*Friend*, Jan. 2017, 12-13). Ask the children to share experiences when they prayed for something and did not receive it. Ask them to share what they learned from their experiences. You might have your own experiences to share as well. Bear your testimony that Heavenly Father always answers our prayers in the way and at the time that will bless us the most.

**Encourage Learning at Home**

Invite the children to be cheerful givers in their homes this week and to come to class next week prepared to report on how they served someone in need.

Improving Our Teaching

Address disruptions with love. "Sometimes a child acts in ways that disrupt the learning of others in the class. When this happens, be patient, loving, and understanding about the challenges the child may be facing. . . . If the child causing disruptions has special needs, talk to the ward or stake disability specialist or visit disabilities.lds.org to find out how you can better meet those needs" (*Teaching in the Savior's Way*, 26).

I can cheerfully give to people in need (2 Corinthians 9:6-7).

Find at least 12 differences between the pictures below of a cheerful giver and an uncheerful giver.

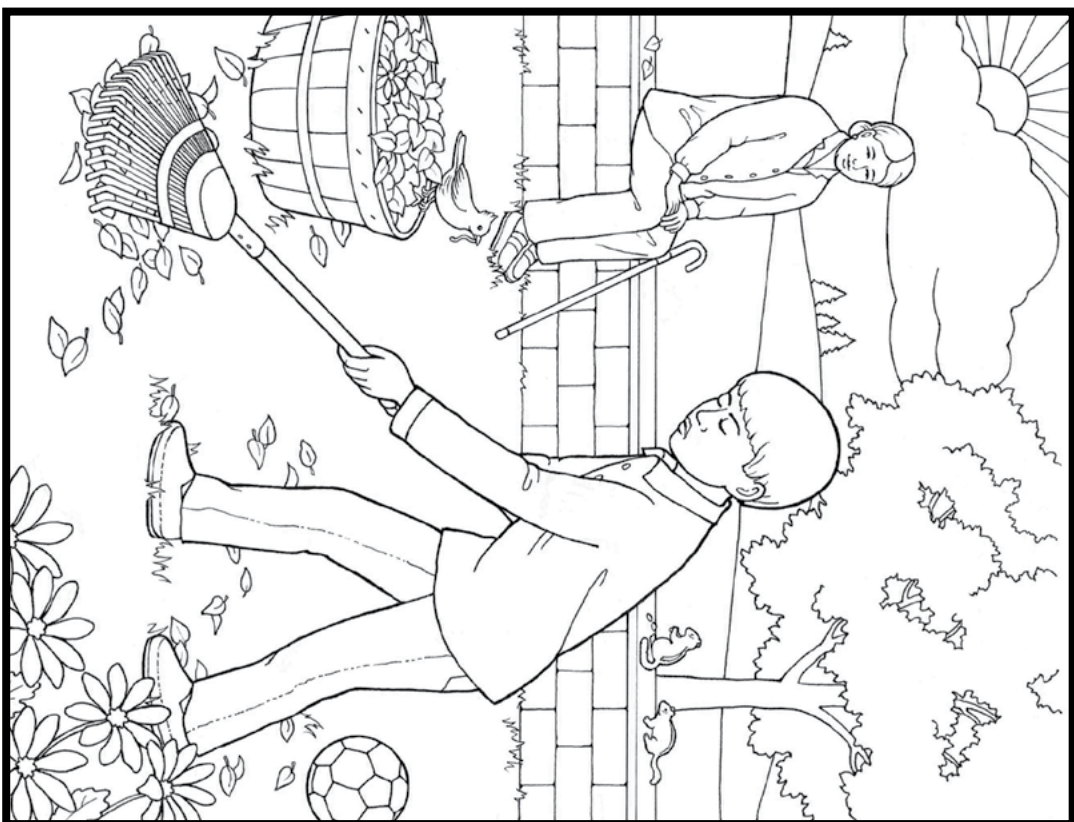
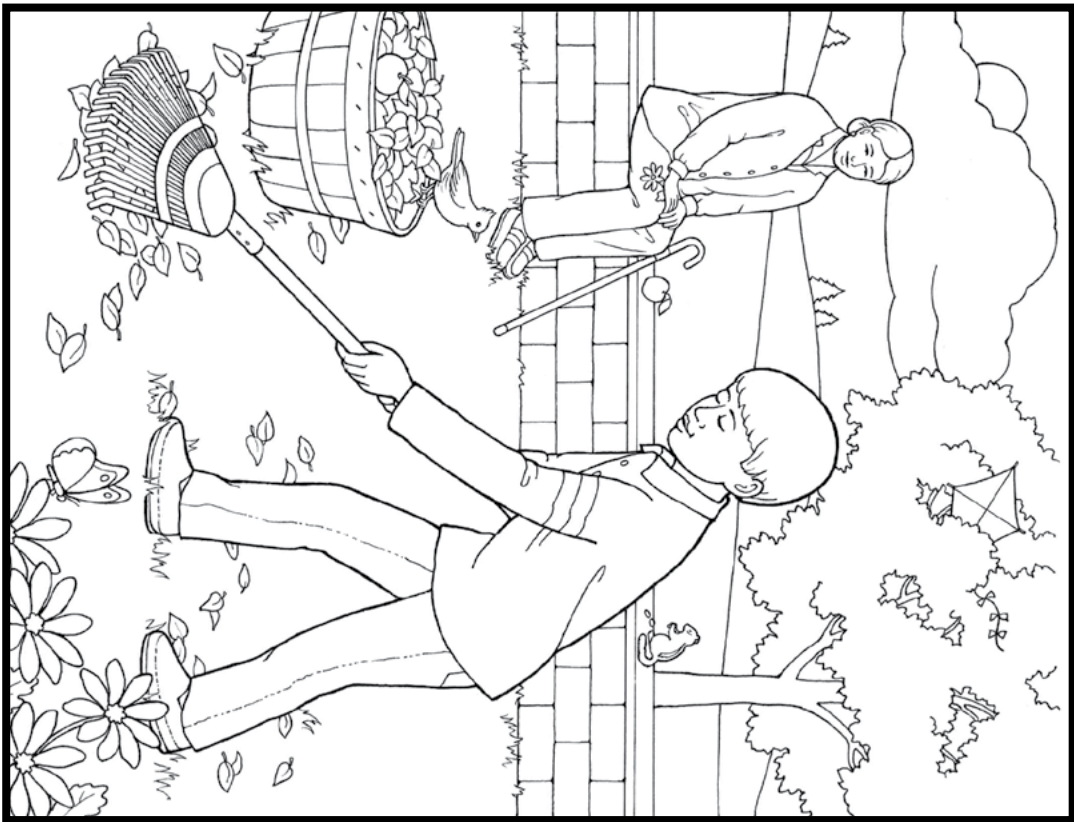



SEPTEMBER 23-29

Galatians

“Walk in the Spirit”

As you read Galatians, what impressions do you have about what the children in your class need to learn?

RECORD YOUR IMPRESSIONS _____



Invite Sharing

Give the children a few minutes to draw something they have learned from a recent gospel discussion at home or at church. Collect the drawings, and let the children try to guess what each drawing represents.



Teach the Doctrine

Younger Children

GALATIANS 5:22-23

The Holy Ghost helps me feel love, joy, and peace.

Young children can recognize the fruit of the Spirit. This will prepare them to seek the influence of the Holy Ghost throughout their lives.

Possible Activities

- Display or show pictures of several kinds of fruit, and ask the children to describe how each fruit

tastes. Explain that just as fruits have different flavors, we can feel the Holy Ghost in different ways, such as love and peace. Ask them to describe how the Holy Ghost feels to them.



Children of all ages can experience the fruit of the Spirit.

- Read Galatians 5:22-23 with the children, and explain words they may not be familiar with. Invite each child to select a fruit of the Spirit mentioned in these verses and tell about a time when he or she experienced that fruit of the Spirit. Invite the children to draw simple pictures of their experiences.

GALATIANS 6:2**Jesus Christ wants me to help those in need.**

The instruction in Galatians 6:2 is similar to Alma's teaching in Mosiah 18:8 to people who were about to be baptized. Take this opportunity to help the children prepare for the covenants of baptism.

Possible Activities

- Show a picture of a child being baptized (such as *Gospel Art Book*, no. 104). Ask the children what the child is doing. Explain that when we are baptized, we make covenants, or promises. Read Galatians 6:2 or Mosiah 18:8 to help the children learn one of the things we promise to do: bear one another's burdens. Invite the children to draw pictures of ways they can help others who are carrying burdens.
- Read to the children this phrase from Galatians 6:2: "Bear ye one another's burdens." To illustrate what this means, give one of the children something heavy to carry. Then ask for a volunteer to help the child carry the object. Explain to the children that many things can feel like a burden, such as being sick or feeling sad or lonely. What could we do to help a person with this kind of burden?
- Show the children several kinds of vegetables, and help them find the seeds in each. Put the seeds in a container, and let the children take turns choosing one and telling what vegetable will grow if they plant it. Help them see that just as the seeds we plant determine the vegetable we get, the choices we make determine the consequences and blessings we ultimately receive.
- Make a line on the floor with tape. Place a happy face and a sad face on opposite ends of the line. Invite a child to stand in the middle of the line, and let the other children name choices that will lead to happiness or sadness (you may need to provide a few examples). For each choice, ask the child in the middle to step toward the happy side or the sad side. Repeat the activity several times, and let other children take turns standing on the tape.

GALATIANS 6:7–9**Our actions, both good and bad, have consequences.**

It is important for children to understand that our choices have consequences. You can use Galatians 6:7–9 to illustrate this truth.

Possible Activities

- Display a seed and a vegetable. Read Galatians 6:7–9 to the children. Ask the children to pretend to plant a seed when they hear the word "soweth." Ask them to pretend to pick a vegetable from a plant when they hear the word "reap."

**Teach the Doctrine**
Older Children**GALATIANS 5:1****Jesus Christ makes us free.**

Some people think the gospel of Jesus Christ limits their freedom. Ponder how you will help the children see that it actually brings liberty from sin and death.

Possible Activities

- Invite the children to read Galatians 5:1. In what ways did Jesus Christ make us free so we could return to Heavenly Father? Show pictures of Jesus's suffering in Gethsemane and His Resurrection to help the children understand how Jesus freed us from sin and death (see *Gospel Art Book*, nos. 56, 59).
- Sing together and review the words to a song about the Savior, such as "I Know That My Redeemer Lives" (*Hymns*, no. 136). Ask the children to find words in this song that describe ways Jesus Christ can free us from spiritual bondage.

GALATIANS 5:22-23**If I “walk in the Spirit,” I can enjoy the “fruit of the Spirit.”**

How will you help the children recognize when they feel the Holy Ghost?

Possible Activities

- Give each child a piece of paper shaped like a fruit, and ask the children to find a “fruit of the Spirit” listed in Galatians 5:22–23. Invite them to write one of the fruits on one side of their paper and a word that means the opposite on the other side. (Help them understand words they aren’t familiar with.) Invite them to share their fruits with the class.
- Invite the children to read about the fruit of the Spirit in Galatians 5:22–23 and write about or draw a picture of a time when the Holy Ghost helped them feel one of those fruits. Ask them to share their story or picture with another person in the class. Why is fruit a good way to help us understand how the Spirit influences us?

GALATIANS 6:7-9**Our actions, both good and bad, have consequences.**

Help the children understand that consequences of our behavior sometimes come immediately and other times may come “in due season” (verse 9).

Possible Activities

- Read together Galatians 6:7–9. Invite the children to draw simple pictures in which someone plants the seed of one fruit and harvests a different fruit. Why would this be impossible? How is making wrong choices and experiencing positive consequences just as impossible?
- As a class, make a maze like the one on this week’s activity page. Invite the children to think of other words than those in the maze that represent good feelings from the Holy Ghost or bad choices that might drive Him away. Discuss the consequences of the choices they thought of.
- Invite the children to list some of the blessings they hope to receive from Heavenly Father. Help them think of the “seeds” they must sow in order to “reap” these blessings.

**Encourage Learning at Home**

Invite the children to watch for the good consequences, or “fruit,” that come because of good decisions they make this week. Tell them that next week they can share their experiences.

Improving Our Teaching

Modify activities for the age of the children. Give children opportunities to participate, but remember that their ability to do so will vary according to their age and maturity. Younger children may need more guidance and direction. As they mature, children can contribute more and may be better at sharing their thoughts. (See *Teaching in the Savior’s Way*, 25–26.)

The Holy Ghost helps me feel love, joy, and peace (Galatians 5:22-23).

Find your way through the path by following the fruits of the Spirit, not the works of the flesh.

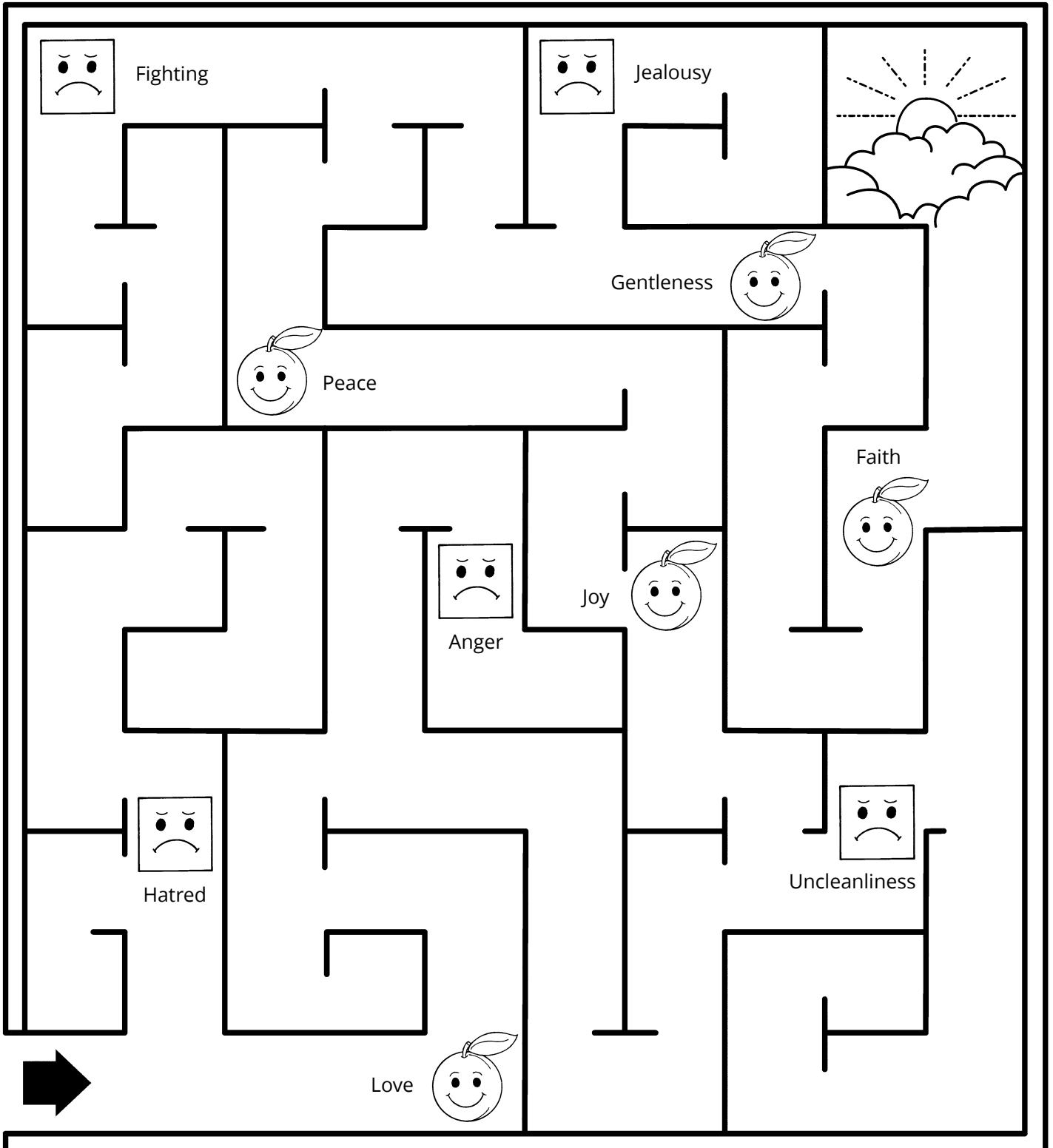



SEPTEMBER 30–OCTOBER 13

Ephesians

“For the Perfecting of the Saints”

As you study the Epistle to the Ephesians, think about what principles you could emphasize to bless the children you teach. Record any ideas that come to mind while you read.

RECORD YOUR IMPRESSIONS _____



Invite Sharing

Invite the children to stand in a line. Ask the first person in line to share something he or she recently learned during family scripture study, in Primary, or elsewhere. Ask the next child in line to repeat what the previous child shared and then add something he or she learned. Repeat this until every child has had an opportunity to share.



Teach the Doctrine

Younger Children

EPHESIANS 2:19

Members of the Church should be friends and “fellowcitizens.”

Are the children in your class more like “strangers” or “fellowcitizens” with each other and with other ward members? Help them understand that although we

have differences, the Savior helps us be unified and love one another.

Possible Activities

- Place a picture of the Savior in the center of the room. Invite the children to stand in different parts of the room to represent “strangers” or “foreigners.” As you read Ephesians 2:19, invite them to move toward the picture of Christ until they are standing close together. Tell them that as we come closer to the Savior, we can become united with others as friends and “fellowcitizens.”
- Find pictures of children from different parts of the world, and hide them around the room. Place a picture of the Savior in the front of the room. Invite your class to pair up like missionaries and take turns finding a picture of a “stranger” to place near the picture of the Savior. Help them understand that when people are baptized, they become part of our Church family, or the “household of God.” How can we help someone who is new feel welcome?

EPHESIANS 6:1–3

Heavenly Father wants me to obey my parents.

As you read Ephesians 6:1–3, think of ways you can help the children understand why it is important to obey their parents.

Possible Activities

- Read Ephesians 6:1 to the class, or help one of the children read it. Ask them to role-play times when they obeyed their parents. What might have happened if they hadn't obeyed?
- Sing together a song about obedience, such as "Quickly I'll Obey" (*Children's Songbook*, 197). Stop after the first line, and ask a child to name something that a parent asks him or her to do; then finish the song. Repeat a few times so other children can have a turn.
- Share an experience in which you obeyed your parents and were blessed. Or share the story about Chloe from Sister Carole M. Stephens's talk "If Ye Love Me, Keep My Commandments" (*Ensign* or *Liahona*, Nov. 2015, 118–20) or show the video "Going to Grandma's" (LDS.org).

EPHESIANS 6:10–18

The armor of God can protect me.

How will you help the children understand that doing righteous things is like putting on armor?

Possible Activities

- Show a picture of a person wearing armor, such as the one in this week's activity page or this week's outline in *Come, Follow Me—For Individuals and Families*. As you summarize Ephesians 6:10–18, show the children how different pieces of armor protect different parts of the body. (See "The Whole Armor of God," *Friend*, June 2016, 24–25.)
- Bring several items to class that could represent the pieces of armor mentioned in Ephesians 6:14–17

(for example, a hat or an apron), or make simple pieces of armor from paper. Let the children take turns putting on the "armor." Discuss what it means to be protected from evil and how putting on each piece of armor can protect them. How do we put on the armor of God? (for example, by studying the scriptures, serving others, praying, obeying, and so on).



Teach the Doctrine
Older Children

EPHESIANS 2:13–19

We are fellowcitizens in the household of God.

Children are strengthened when they have good friends in the gospel. How can you help them develop better friendships with each other?



We are "fellowcitizens" with the Saints of God.

Possible Activities

- Read Ephesians 2:19 together, and discuss what it means to be a stranger or foreigner. Share an experience in which you felt like a stranger or foreigner and someone helped you feel welcome and accepted. Invite the children to share similar experiences. What can we do to become "fellow-citizens" rather than strangers? Are there any children in your class who do not attend often, perhaps because they feel like strangers? Help

the children come up with a plan to help those members feel welcomed and loved.

- To help the children you teach draw closer to one another, write some questions on the board that prompt them to share something about themselves, such as *When have you had a prayer answered?* or *What's your favorite thing to do with your family?* Divide the children into pairs, and invite them to ask each other the questions. What did they learn about each other?

EPHESIANS 6:1-3

Heavenly Father wants me to obey and honor my parents.

Think about ways you can help the children understand why it is important to obey their parents.

Possible Activities

- Invite the children to read Ephesians 6:1-3 individually and identify phrases that stand out to them. Invite them to share these phrases and why they feel the phrases are important.
- Invite the children to share examples of people in the scriptures who obeyed and honored their parents, such as the Savior (see Luke 2:42-52), Ruth (see Ruth 1), or Nephi (see 1 Nephi 3:1-8). Why is it important to obey and honor our parents?
- Give each child a piece of paper with the word *honor* at the top. Discuss what the word means. Invite the children to write or draw on their papers

something they can do to show that they honor their parents.

EPHESIANS 6:10-18

The armor of God can protect me from evil.

As you read Ephesians 6:10-18, think of some of the spiritual dangers that children face and how you can help strengthen the children against them.

Possible Activities

- As one child reads Ephesians 6:10-18, ask another child to list or draw on the board the pieces of armor mentioned. Why is armor important in a battle? How can we put on spiritual armor every day?
- Assign each child to draw and label a piece of armor described in Ephesians 6:14-17. How might these pieces of armor protect us from evil? What does the Lord promise to those who put on the armor of God? (see Ephesians 6:13). What does it mean to "withstand in the evil day"?



Encourage Learning at Home

Invite the children to be watching this week for someone who might feel like a stranger. Challenge them to do something to reach out to that person.

Improving Our Teaching

Help young children learn from the scriptures. To help young children learn from the scriptures, focus on a single verse of scripture or even just a key phrase. You might invite the children to stand up when they hear a specific word or phrase. (See *Teaching in the Savior's Way*, 25-26.)

The armor of God can protect me from evil (Ephesians 6:10-18).

Color, cut out, and dress either the boy or the girl with the armor of God.

As you glue on each piece of armor, discuss what each piece represents (see Ephesians 6:10-18).

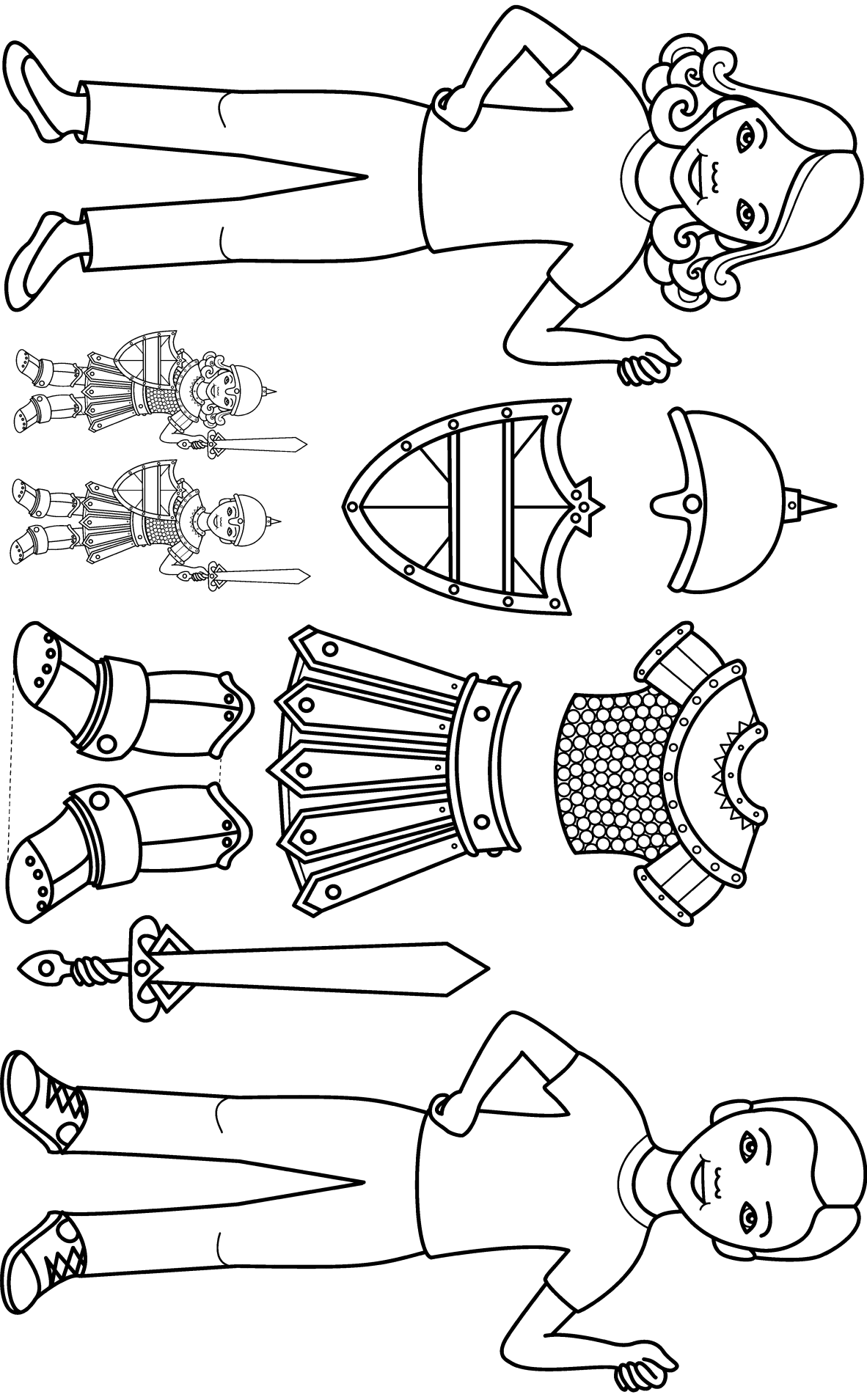



OCTOBER 14-20

Philippians; Colossians

“I Can Do All Things through Christ Which Strengtheneth Me”

Read *Philippians* and *Colossians*, thinking about the children you teach. Seek inspiration about how to teach them the principles in these epistles.

RECORD YOUR IMPRESSIONS _____



Invite Sharing

Ask the children what they did this past week to reach out to someone who needed a friend, as discussed in last week’s class.



Teach the Doctrine

Younger Children

PHILIPPIANS 1:3-4; COLOSSIANS 1:3, 9

Church leaders love me and pray for me.

Paul often began his epistles by expressing love for Church members and telling them that he prayed for them. Consider how you can help the children understand that their Church leaders love them.

Possible Activities

- Read *Philippians* 1:3-4 and *Colossians* 1:3, 9 aloud, and ask the children to fold their arms and bow their heads every time they hear the words *pray*, *praying*, and *prayer*. Explain that the Apostle Paul

prayed for Church members, just as our Church leaders pray for us today.

- Show a picture of Jesus Christ, and share examples of Him praying for someone (see *Luke* 22:32; *3 Nephi* 19:21, 23). What did Jesus ask for when He prayed for others?
- Help the children name some of their Church leaders, such as the Primary president, the bishop, and the President of the Church. Explain that these leaders ask Heavenly Father to bless the children and help them live righteously. Consider telling the children what you say when you pray for them.

PHILIPPIANS 4:4, 8

I can rejoice in the Lord.

Paul encouraged the Saints to rejoice—even though they faced difficult trials and Paul himself was in captivity. How will you help the children see that living the gospel brings joy?

Possible Activities

- Ask the children to listen for a repeated word as you read *Philippians* 4:4. Ask the children to show

you what they might do when they rejoice. Help them understand that to “rejoice in the Lord” means to feel happy because we have the gospel and because Jesus Christ loves us.

- Bring objects or pictures that represent things that help you “rejoice in the Lord.” You could bring a beautiful creation of God or a picture of a temple, the resurrected Savior, or a family. Let the children take turns selecting a picture or object, and then tell them why it makes you happy. Invite them to share things that help them rejoice in the Lord.
- Read Philippians 4:8 together, and help the children think of things that fit the descriptions in the verse (see also Articles of Faith 1:13). Give the children pieces of paper and let them draw pictures of these things to help them “think on” the things Paul described.

COLOSSIANS 1:23; 2:6–7

My faith should be “rooted” in Jesus Christ.

If the children can build their lives and their faith on the Savior, they will be able to withstand the storms of life.

Possible Activities

- Show the picture of a tree from this week’s outline in *Come, Follow Me—For Individuals and Families* while you read key phrases from Colossians 1:23; 2:6–7. (Or show the video “Spiritual Whirlwinds” on LDS.org.) What would happen to this tree if a storm came and the tree did not have strong roots? Let the children stand and pretend to be a tree that has weak roots in a storm and then a tree with strong roots. How can faith in the Savior help us be like a tree with strong roots?
- Invite a child to draw a tree on the board. Ask the children to name some things they can do to be “rooted” in Jesus Christ. Each time a child names something, invite him or her to add a root to the drawing.



Teach the Doctrine

Older Children

PHILIPPIANS 4:4–13

If I have faith in Jesus Christ, I can be happy even during hard times.

Paul suffered many trials, but he was happy because he had faith in Jesus Christ.

Possible Activities

- Ask the children to imagine that they are in prison, just as the Apostle Paul was when he wrote the epistle to the Philippians. Read Philippians 4:4–13 with the children and ask them to look for the following words: *rejoice, peace, content*. Why was Paul able to rejoice and feel peace even in prison? Help the children find the words *Lord, God, and Christ* in the verses. Help them understand that Paul’s faith in Jesus Christ made it possible for him to rejoice.
- Invite the children to help you complete sentences like the following: I can be in the dark and still see if I have a _____. I can be outside on a hot day and still feel cool if I have a _____. I can have hard times and still find joy if I _____. Help the children think of ways they can find joy in Jesus Christ when they have hard times. They can sing a hymn, read a favorite scripture, serve someone, or say a prayer of thanks. What does Philippians 4:4–13 suggest? Share with the children some hymns or scriptures that help you find joy during hard times.

PHILIPPIANS 4:8

I can think on things that are true, honest, and pure.

Children are often exposed to things that are evil and impure. You can help them seek after uplifting and virtuous things.

Possible Activities

- Ask one child to read Philippians 4:8 aloud while the others look for words in Articles of Faith 1:13 that are the same or similar. Invite someone to write these words on the board. Provide simple definitions of these words and have the children match the definitions to the words. Why should we “think on” these things? How can we “seek after” them?
- Ask the children to name things that fit the descriptions in Philippians 4:8. Invite them to keep a list this week of anything they notice that fits these descriptions. Encourage them to bring their lists to Primary next week and share what they found.

COLOSSIANS 1:23; 2:6–7

My faith should be “rooted” in Jesus Christ.

Satan tries to weaken the children’s faith through temptations and false doctrines. How can you inspire the children to strengthen their faith in the Savior so

that they are “not moved away from the hope of the gospel”?

Possible Activities

- Invite the children to draw pictures that represent the truths they find in Colossians 1:23; 2:6–7. Let them share their pictures with the class and explain the truths their pictures represent.
- Show the video “Spiritual Whirlwinds.” What are some temptations and false doctrines in the world today that can weaken our faith? What can we do to strengthen our faith so that we are “rooted” in Jesus Christ?



Encourage Learning at Home

Invite the children to share with their families what they learned about being “rooted” in Christ. They could use this week’s activity page or a scripture they read during class today.

Improving Our Teaching

Children are curious and learn through new and varied experiences. Use activities that help children move about, use all their senses, explore, and try new things. The suggestions in “Meeting the Needs of Younger Children” at the beginning of this resource can help. (See also *Teaching in the Savior’s Way*, 25–26.)

**When my faith is rooted in Jesus Christ, He can help me
make good choices (Colossians 1:23; 2:6-7).**

Color the picture. Trace the paths from the pictures of good choices to the end of their roots.

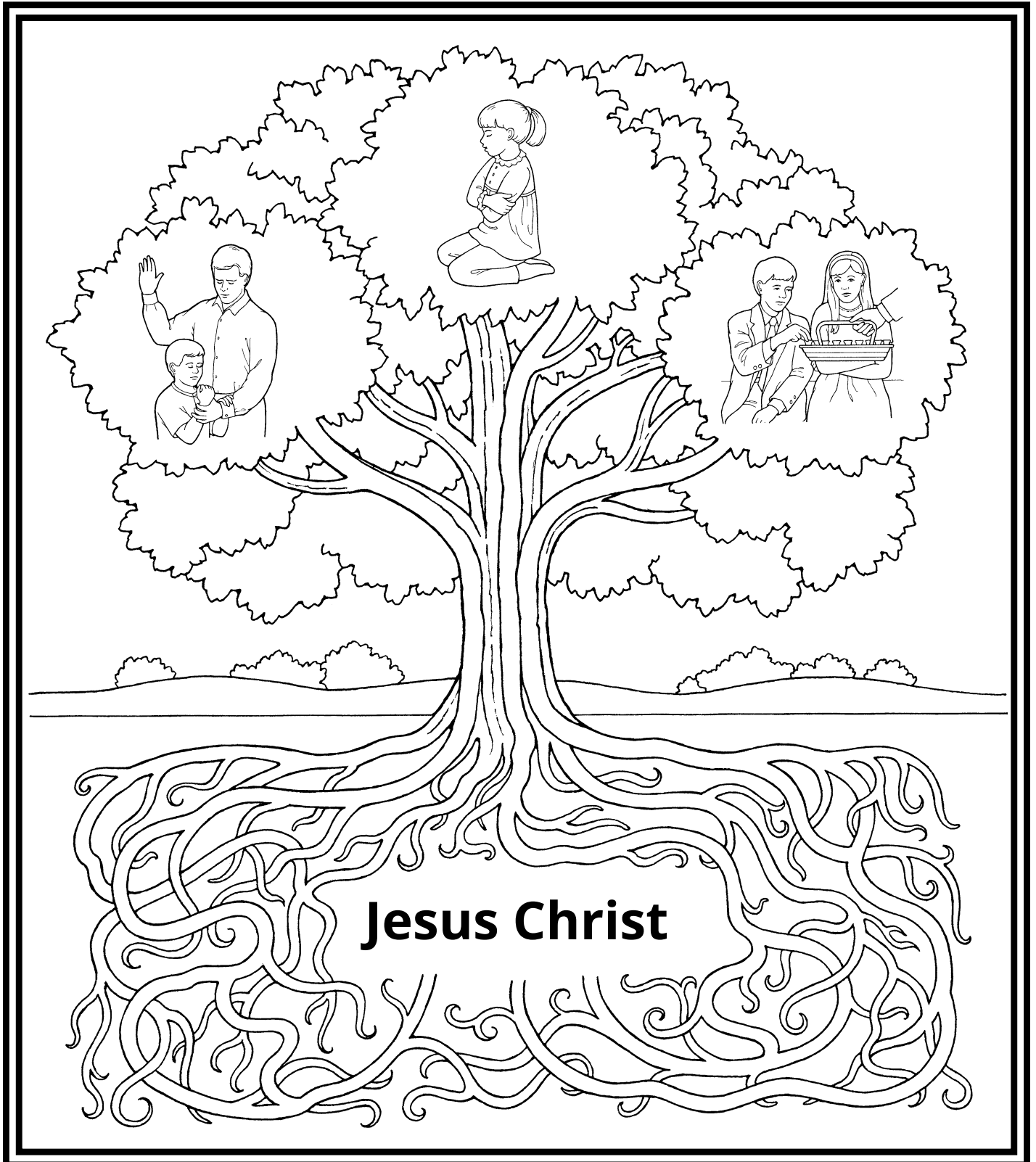



OCTOBER 21-27

1 and 2 Thessalonians

“Be Not Soon Shaken in Mind, or Be Troubled”

As you prayerfully read 1 and 2 Thessalonians with the children in mind, you will find principles that they need to understand.

RECORD YOUR IMPRESSIONS _____



Invite Sharing

In last week’s lesson, did you invite the children to apply what they learned in some way? Let the children use the first few minutes of this week’s class to share their experiences.



Teach the Doctrine

Younger Children

1 THESSALONIANS 5:1-6

**As I follow God’s commandments,
I will be ready for the Second Coming
of Jesus Christ.**

Paul’s counsel can help us be ready and watching for that great day when the Savior comes to earth again.

Possible Activities

- Invite a mother to talk about what it was like to wait for her baby to be born without knowing

exactly when the birth would happen. Read 1 Thessalonians 5:2-3, and tell the children that Jesus Christ will come to earth again, but no one knows exactly when—just as a mother doesn’t know exactly when her baby will be born.

- Ask the children to talk about a time when they prepared for a trip or event. What did they do to prepare? Bring a suitcase or bag and let the children pretend to pack it in preparation for a trip or event. Explain that we prepare for Jesus Christ to come again by praying, reading the scriptures, following the prophet, and living righteously each day. Ask the children to draw pictures of how they can do this and put them in the suitcase.
- Read 1 Thessalonians 5:6 to the children and explain that if we are not preparing for Jesus to come again, it’s like we have fallen asleep and we won’t be ready for Him. Invite the children to pretend they are asleep. Explain that if we do prepare, it’s like we are awake and waiting for Him. Invite them to wake up. Sing together “When He Comes Again” (*Children’s Songbook*, 82-83).

2 THESSALONIANS 2:1–3**Paul taught that an apostasy would occur before Jesus Christ comes again.**

The Church that Jesus Christ established eventually fell into apostasy, meaning that priesthood authority and gospel truths were taken from the earth. Paul prophesied that this apostasy, or “falling away,” would happen before the Savior’s Second Coming.

Possible Activities

- After reading 2 Thessalonians 2:3 with the children, build a tower out of plastic cups or blocks. Tell the children that the cups or blocks represent important parts of the true Church, such as gospel truths, the priesthood, temple sealings, and prophets. After Paul and the other Apostles died, these things were lost, and the true Church was not on the earth for many years. Invite a child to knock the tower over, and explain that this was called the Apostasy or “falling away.” When Jesus Christ brought His Church back, it was called the Restoration. (See “Apostasy,” *True to the Faith*, 13–14.)
- Display a Book of Mormon and pictures of the prophet and a temple. Invite the children to say “Apostasy” when you hide the items in a bag and “Restoration” when you bring the items back out.
- Sing songs that teach truths that were taken away during the Apostasy and restored in our day, such as “I Am a Child of God,” “The Church of Jesus Christ,” and “I Love to See the Temple” (*Children’s Songbook*, 2–3, 77, 95).



Teach the Doctrine

Older Children

1 THESSALONIANS 5:1–6**As I follow God’s commandments, I will be ready for the Second Coming of Jesus Christ.**

Paul’s counsel can help us be ready and watching for that great day when the Savior comes to earth again.

Possible Activities

- Invite a child to read 1 Thessalonians 5:1–6 while the other children follow along. After each verse, ask a child to summarize what he or she thinks the verse is saying. You may want to explain that “the day of the Lord” means the Second Coming of Jesus Christ. Why do the children think the Second Coming is compared to a thief in the night or a woman about to have a baby?
- Tell the children to imagine that the Savior will be visiting your class sometime today. How can we prepare our classroom for His visit? Help the children think of things we can do to prepare ourselves for the day Jesus Christ returns. For example, we can repent, forgive, improve our relationships with our family, follow the prophet, and keep our covenants. Encourage the children to choose one thing they will do to prepare themselves to receive the Savior at His Coming.

2 THESSALONIANS 2:1–3**Paul taught that an apostasy would occur before Jesus Christ comes again.**

If the children understand that Jesus Christ’s Church and His gospel were taken away from the earth during the Great Apostasy, the necessity of the Restoration will become clearer to them.

Possible Activities

- Invite one of the children to read 2 Thessalonians 2:1–3. According to these verses, what had to happen before “the day of Christ,” which means the Second Coming? Do any of the children know what “a falling away” means? Make sure that the children understand that it means the Great Apostasy, which occurred after the deaths of the Savior’s Apostles. You might want to share information from “Apostasy,” *True to the Faith*, 13–14.
- Help the children list on the board some of the truths and blessings we enjoy because of the gospel. (Some examples might include temples, prophets, the priesthood, and the gift of the Holy Ghost.) Erase these things one by one, and ask the children how their lives would be different without these things. Explain that these truths were lost during the Great Apostasy. Why was it important that the Church of Jesus Christ be restored to the earth in the latter days? Invite the children to “restore” or rewrite the truths and blessings on the board.

2 THESSALONIANS 3:7–13

Heavenly Father wants me to work.

How can you help the children see work as a blessing, not something to avoid?

Improving Our Teaching

Support the children’s parents. “Parents are the most important gospel teachers for their children—they have both the main responsibility and the greatest power to influence their children (see Deuteronomy 6:6–7). As you teach children at church, prayerfully seek ways to support their parents in their essential role” (*Teaching in the Savior’s Way*, 25).

Possible Activities

- Invite the children to take turns reading verses from 2 Thessalonians 3:7–13 and look for the problem the Saints were facing. Why does Heavenly Father want us to work? What would happen if we never learned to work hard? Let the children take turns acting out simple chores while the other children guess what they are doing.
- Invite the children to talk about a time when they worked hard on a task, a project, or a goal. How did they feel about themselves when they finished? What does it mean to “be not weary in well doing”? (2 Thessalonians 3:13).



Encourage Learning at Home

Invite the children to tell a family member or friend one reason they are grateful we have the gospel on the earth today (this week’s activity page can help them remember).

Paul taught that an Apostasy would precede the Second Coming of Jesus Christ (2 Thessalonians 2:1-3).

Color and cut out both pieces of the spinner. Place the piece with the earth on top and attach both pieces in the center.

Use the spinner to show how temples, prophets, and priesthood authority were on the earth during the early Church, were lost during the Apostasy, and were restored to the earth in our day.

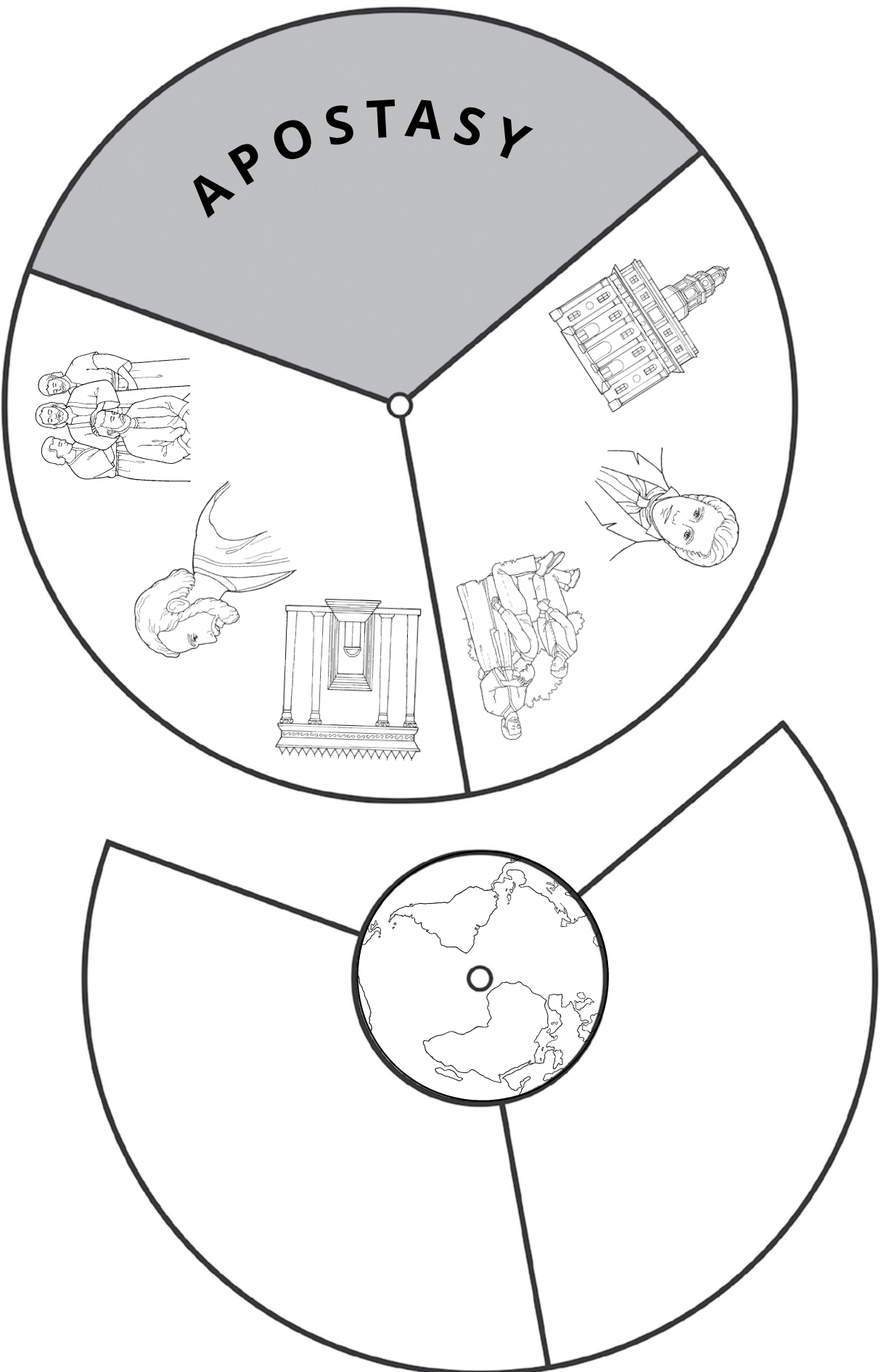



OCTOBER 28–NOVEMBER 3

1 and 2 Timothy; Titus; Philemon

“Be Thou an Example of the Believers”

Prayerfully study 1 and 2 Timothy; Titus; and Philemon to learn how you can use these epistles to instruct the children in righteousness (see 2 Timothy 3:16).

RECORD YOUR IMPRESSIONS _____



Invite Sharing

Ask the children to talk about someone who is a good “example of the believers” to them. What are they doing to be good examples to others?

do? How does he bless the ward? (You can find some characteristics of a bishop in 1 Timothy 3:1–2 and Titus 1:7–9.) As the children share their ideas, write them on strips of paper and let the children place them on the board by the drawing.



Teach the Doctrine

Younger Children

1 TIMOTHY 3:1–2; TITUS 1:7–9

Bishops lead the ward as servants of God.

Paul taught Timothy and Titus about the importance of bishops. How can you teach the children what the bishop does? (A branch president is comparable to a bishop.)



Bishops are called to provide spiritual guidance to ward members.

Possible Activities

- Draw a simple picture of your bishop on the board. Ask the children to name some things they know about the bishop. What is he like? What does he

- Write the duties of a bishop on slips of paper—such as accepting tithing and fast offerings, extending callings, interviewing members, helping the poor and needy, and praying for others. Place these slips in a bowl, and invite each child to pick one. Then help the child to role-play these duties with you. Share your testimony that your bishop is called of God.

- Invite the children to draw a picture of the bishop serving ward members. Suggest that they give their drawings to him to thank him. What can we do to help him?

1 TIMOTHY 4:12

I can be “an example of the believers.”

What can you do to inspire the children to be confident in their ability to be “example[s] of the believers”?

Possible Activities

- Sing with the children “Do as I’m Doing” (*Children’s Songbook*, 276). Ask the children to follow your example by doing the actions you do. Let the children take turns leading the rest of the class in following their actions. Read 1 Timothy 4:12, and ask the children what they can do to be good examples to others.
- Share an experience when you tried to be a good example to someone or when someone was a good example to you. Help the children understand that when they are good examples, they can help their family members and friends.

2 TIMOTHY 3:14–17

The scriptures will help me learn truth.

If you can help the children learn to love the scriptures, you will bless their lives for years to come.

Possible Activities

- Display a set of scriptures, and help the children become familiar with them by showing them the title pages of the Bible, the Book of Mormon, the Doctrine and Covenants, and the Pearl of Great Price. Invite a child to hold these books as you read 2 Timothy 3:15–17. Explain that Heavenly Father has commanded prophets throughout history to write the truths that He reveals to them. We can learn these truths as we read the scriptures.

- Ask the children to talk about their most prized possession. What do they do with it? Let them take turns holding the scriptures and carefully turning the pages. What do we use the scriptures for? Why should we take good care of them? Help the children create actions to go with songs about the scriptures, such as “Search, Ponder, and Pray” or “Book of Mormon Stories” (*Children’s Songbook*, 109, 118).



Teach the Doctrine Older Children

1 TIMOTHY 4:12

I can be “an example of the believers.”

Timothy was relatively young for a Church leader, but Paul wanted him to know that he could still be an example. You can help the children you teach feel confident in their ability to set a good example.

Possible Activities

- Read together 1 Timothy 4:12, and ask the children to find six ways Paul said we can be “an example of the believers.” Divide the children into pairs, and invite each pair to think of a situation in which they can be an example of the believers. Ask them to role-play their situation for the rest of the class.
- Ask the children if they would like to share any experiences when they tried to be a good example to others. Tell them how they have been examples of the believers to you and how you have noticed them setting good examples for others.

1 TIMOTHY 6:7–12

I should love eternal things more than money.

In a world that is becoming more and more materialistic, how can you help the children keep their focus and love centered on Heavenly Father and Jesus Christ?

Possible Activities

- Invite the children to talk about what they would buy if they had all the money in the world. Invite a child to read 1 Timothy 6:7–12, and ask the other children to summarize what Paul taught Timothy about money. Then invite the children to read the verses again, searching for things Paul mentioned that are more valuable than money.
- Lay out pictures of worldly things (such as money, toys, or entertainment) and eternal things (such as families or temples). Invite the children to sort the pictures into two piles—things that bring us closer to Christ and things that might distract us from Christ if we love them more than we love Him. Why is “the love of money . . . the root of all evil”?

2 TIMOTHY 3:14–17

Heavenly Father gave us scriptures to help us know truth from error.

Children can experience the blessings of reading the scriptures. As you teach the children about the scriptures, look for ways to encourage them to have their own powerful experiences with the word of God.

Possible Activities

- Invite the children to read 2 Timothy 3:15–17. Bring a picture depicting a story from each of the four standard works, and put the pictures in a covered box. Invite several children to pick a picture and tell the story. Ask the children if they can share something else about that book of scripture. How are the scriptures “able to make [us] wise unto salvation”?
- Invite the children to share their favorite scripture verse or an experience when a truth in the scriptures has helped them. You may want to share your own verse or experience.
- Ask a child to read Moroni 10:4–5. What did Moroni promise in these verses? Ask the children what they have done to gain a testimony that the scriptures are true. Invite them to read or listen to the scriptures regularly.



Encourage Learning at Home

Invite the children to share with their families what they learned about the scriptures and to find one verse of scripture that they can share with the class next week (with help from their parents, if needed).

Improving Our Teaching

Adapt activities to meet needs. Instead of viewing these outlines as instructions you must follow, use them as a source of ideas to spark your own inspiration as you ponder the needs of the children you teach. You can adapt activities to teach children of any age.

The scriptures will help me learn truth (2 Timothy 3:15-17).

Color and cut out the books of scripture. Write or draw a truth or favorite scripture story from each book on its blank side. Fold each book in half and punch a hole in the corner so you can string the books together.

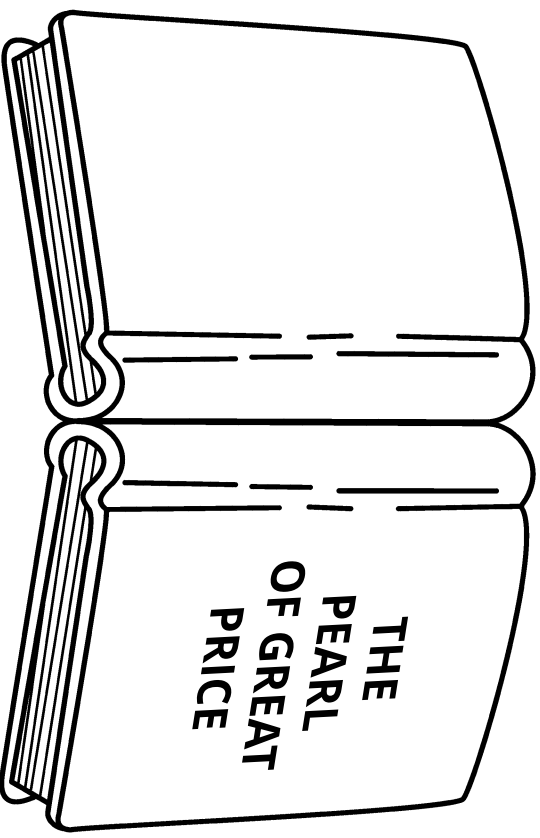
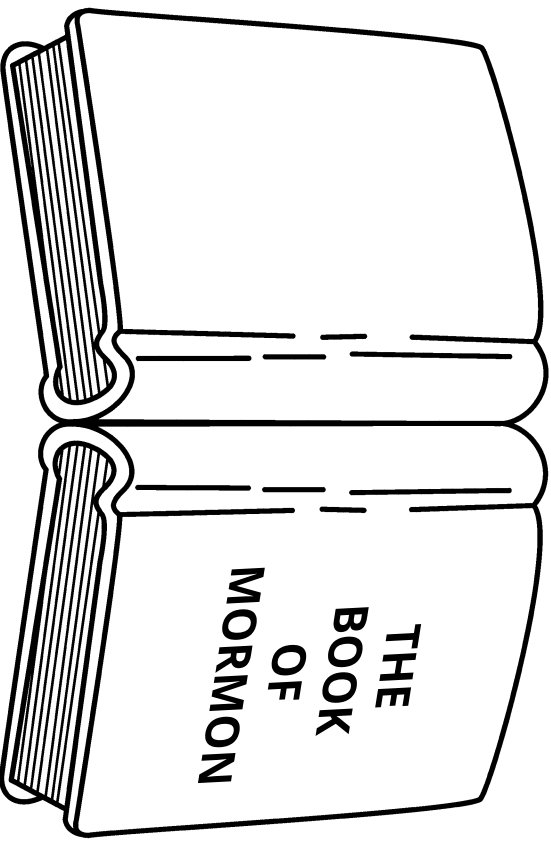
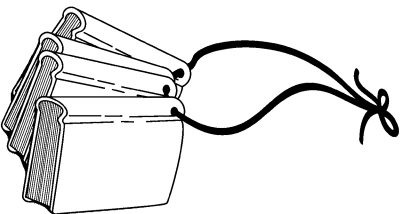
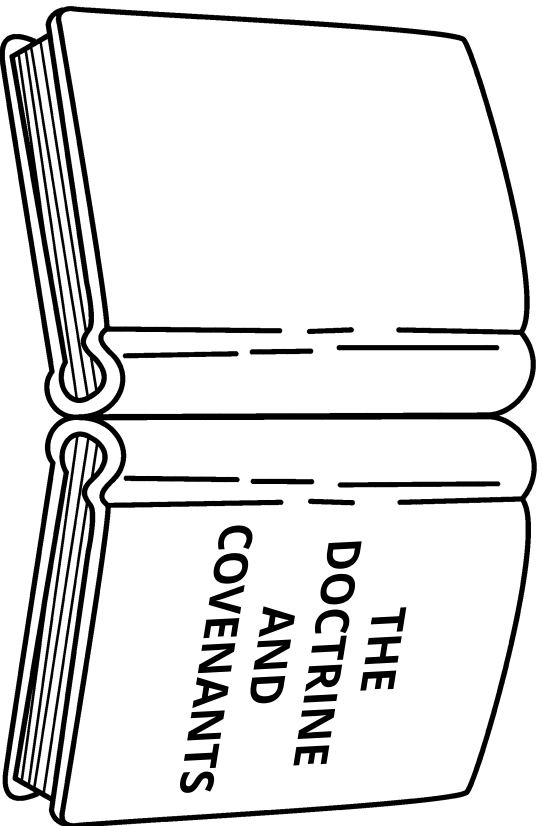
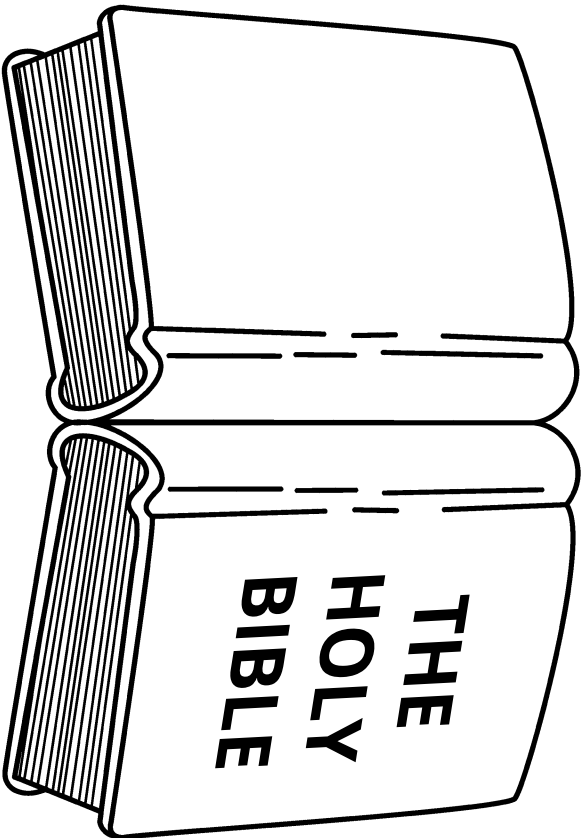



Balm of Gilead, by Annie Henrie

NOVEMBER 4-10

Hebrews 1-6

Jesus Christ, “the Author of Eternal Salvation”

What truths do you find in Hebrews 1-6 that you feel inspired to teach to the children? Pay attention to promptings from the Spirit that come as you prepare, and be sure to record them.

RECORD YOUR IMPRESSIONS _____



Invite Sharing

Did the children accept the invitation at the end of last week’s lesson to find a verse of scripture they can share? If so, give them time to share it. If not, help them think of something they have learned from the scriptures recently that they can share.

1:2-10; 2:8-10, 17-18, and hide them around the room. Invite the children to find the paper strips. Help them read the truths written on the papers, and talk about what these truths mean. If necessary, explain that Jesus is called the Son of God because Heavenly Father is the father of both His spirit and His body.

- Pass a picture of the Savior around the room, and let each child share why he or she is thankful for Jesus Christ while holding the picture.



Teach the Doctrine

Younger Children

HEBREWS 1:2-10; 2:8-10, 17-18

I believe in Jesus Christ.

These verses can help the children learn more about Jesus Christ and strengthen their relationship with Him.

Possible Activities

- Using your own words, write on strips of paper truths about Jesus Christ that you find in Hebrews

HEBREWS 3:8

Heavenly Father wants us to “harden not [our] hearts.”

Hebrews 3 gives the example of the Israelites hardening their hearts and rejecting the Lord’s blessings. It also is a warning to all of us not to harden our hearts.

Possible Activities

- Bring a sponge (or washcloth) and a rock to class. Invite the children to touch the objects and describe how the objects feel. Put a few drops of

water on each object, and point out that more water soaks into the sponge than into the rock. Explain that our hearts need to be soft and not hard so that we can accept Heavenly Father's truths into our hearts.

- Cut a heart shape out of a soft material, such as cloth, and a harder material, such as cardboard. Tell the children that when we listen and obey we have a soft heart and when we don't listen and don't obey we have a hard heart. In your own words, share some examples from the scriptures of people who had soft hearts or hard hearts (such as Nephi, Laman, and Lemuel [1 Nephi 2:16–19], Paul [Acts 9:1–22], or Joseph Smith [Joseph Smith—History 1:11–20]). As you share each example, invite the children to point to the soft heart or the hard heart.



Moses Calls Aaron to the Ministry, by Harry Anderson

HEBREWS 5:4

Priesthood holders are called of God.

Hebrews 5:4 is an important verse because it clarifies that priesthood holders—and others who serve in the Church—must be called by God.

Possible Activities

- Read Hebrews 5:4 to the children. Ask a priesthood holder to explain what the priesthood is and share his experience receiving the priesthood.

- Help the children memorize phrases from the fifth article of faith. Bear your testimony that people who are called to do God's work are called by God through revelation.



Teach the Doctrine

Older Children

HEBREWS 1:2–10; 2:8–10, 17–18

I believe in Jesus Christ.

The Epistle to the Hebrews was written to strengthen the Hebrew Saints' faith in Jesus Christ. It can do the same for the children you teach.

Possible Activities

- Assign each child a few verses in Hebrews 1:2–10; 2:8–10, 17–18, and invite the children to search in those verses for truths about Jesus Christ. Let them share or write on the board what they find. What else do we know about Jesus Christ? The children might find some ideas in songs such as "I Know That My Redeemer Lives" (*Hymns*, no. 136) or "He Sent His Son" (*Children's Songbook*, 34–35).
- Invite the children to draw pictures of themselves with their parents. Ask them to share what they have in common with their parents. Explain that when Hebrews 1:3 says that Jesus Christ is "the express image of [God's] person," it means that Jesus and Heavenly Father have the same qualities and attributes. Testify that we learn about Heavenly Father by learning about and following Jesus Christ.
- Help the children think of people with whom they could share their testimony of Jesus Christ. Consider inviting them to practice sharing what they would tell those people about Jesus.

HEBREWS 3:7-19**To receive Heavenly Father's guidance and blessings, we must "harden not [our] hearts."**

In Hebrews 3, the story of the Israelites in the wilderness is used to teach the importance of not hardening our hearts. How can you use this story to teach the children in your class this principle?

Possible Activities

- Ask the children to think of things that are hard and soft. (You may want to bring some examples to show them.) Read together Hebrews 3:8. What does it mean to have a hard heart? Why does God want us to have soft hearts?
- In your own words, share the story of the Israelites hardening their hearts against the Lord in the wilderness (see Numbers 14:1-12; Hebrews 3:7-19). Let the children act out the story. What will happen if we harden our hearts against the Lord and His gospel?
- Invite the children to read Matthew 13:15; Hebrews 3:15; Mosiah 11:29; and Moses 6:27. Ask them to draw on the board the body parts mentioned in these verses. What does it mean to have spiritually dull ears, blind eyes, and hard hearts? How can we make sure that our ears, eyes, and hearts are ready to receive God's blessings?

HEBREWS 5:1-4**Priesthood holders are called of God.**

Hebrews 5 provides an opportunity to discuss what the priesthood is—the power and authority to act in God's name—and how it is received. This may be especially helpful for boys who are preparing to be ordained to the priesthood.

Possible Activities

- Show the picture *Moses Gives Aaron the Priesthood* (*Gospel Art Book*, no. 15) while a child reads Hebrews 5:4. It may be helpful to explain that because Aaron was the first person to hold the Aaronic Priesthood, it was named after him. Help the children think of duties Aaronic Priesthood holders perform (such as baptizing, blessing and passing the sacrament, and inviting others to come unto Christ).
- Help the children think about different ways in which people receive authority. For example, how does a teacher, doctor, or political leader receive authority? How does God give His authority? Invite the children to think about this question as they read Hebrews 5:4 and the fifth article of faith.

**Encourage Learning at Home**

Invite the children to share a scripture, song, or activity they learned in class today with their families for a family home evening.

Improving Our Teaching

Children can recognize the influence of the Spirit. Teach the children that the feelings of peace, love, and warmth they have when they talk or sing about Jesus Christ and His gospel come from the Holy Ghost. These feelings can build their testimonies.

I believe in Jesus Christ (Hebrews 1:2-10; 2:8-10, 17-18).

Start at number 1 and connect the dots in order by number.
Color the picture and write your testimony of Jesus Christ on the lines below.

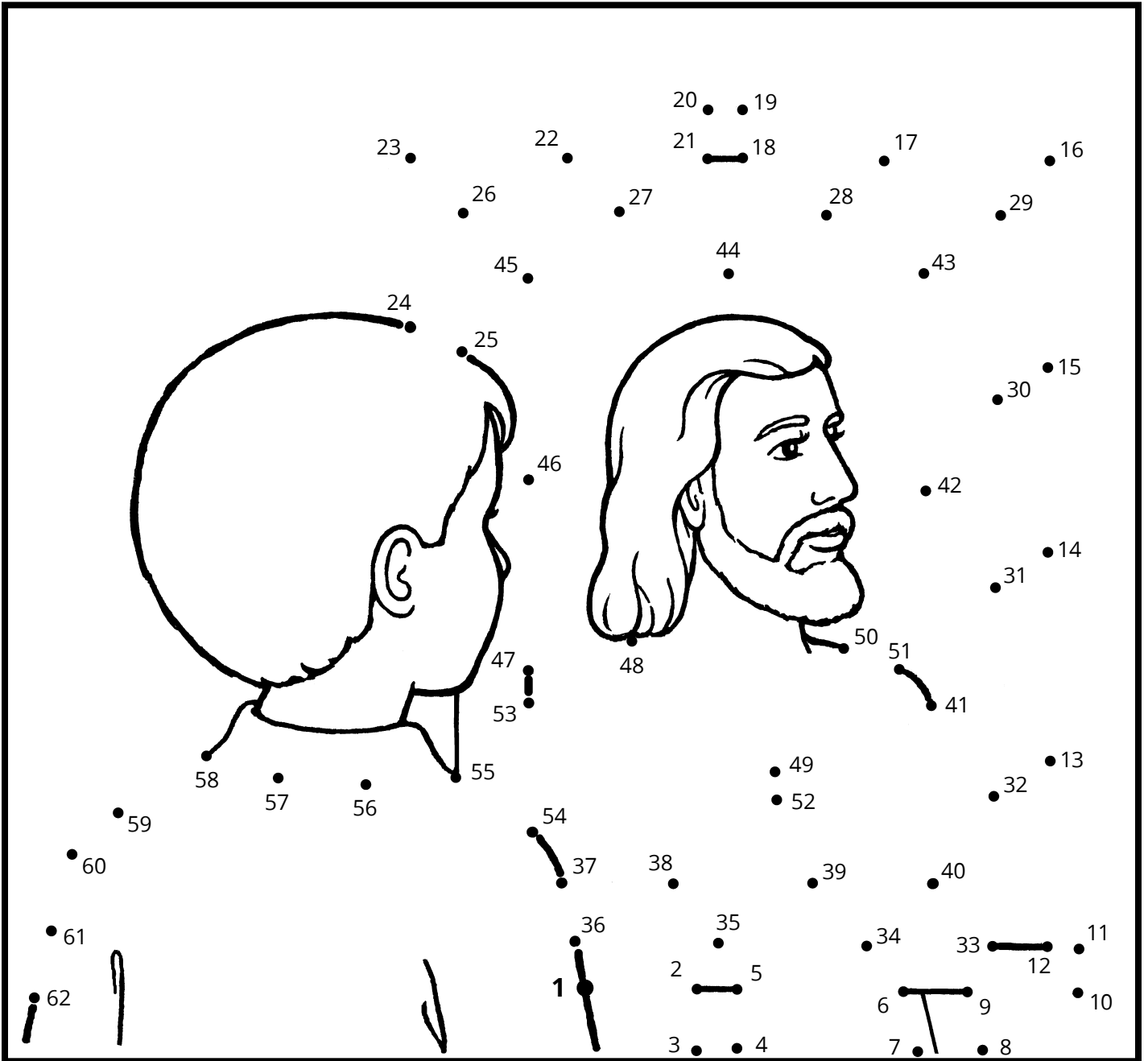

My Testimony of Jesus



Melchizedek Blesses Abram,
by Walter Rane

NOVEMBER 11-17

Hebrews 7–13

“An High Priest of Good Things to Come”

As you review and ponder this outline, pay attention to the promptings you receive about the children you teach. The Spirit will help you find messages for them in Hebrews 7–13.

RECORD YOUR IMPRESSIONS _____



Invite Sharing

Ask the children to share things they and their families do to learn the gospel at home. Invite them to share some of their favorite experiences with learning the gospel with their families.



Teach the Doctrine Younger Children

HEBREWS 7:1-6

The priesthood can help us in many ways.

Hebrews 7:1–6 can provide an opportunity to introduce to the children the blessings of the priesthood.

Possible Activities

- Briefly explain who Abraham was, and then use Hebrews 7:1–6 and Joseph Smith Translation, Genesis 14:36–40 (in the Bible appendix) to teach that Abraham paid tithing to Melchizedek. Explain

that Melchizedek held the higher priesthood, which is God’s power given to men on earth, and he used it to bless Abraham. The children may enjoy acting out the story with simple props, like a crown and a tithing envelope.

- Invite an Aaronic and a Melchizedek Priesthood holder to visit the class and tell the children how they have used the priesthood to bless others. Then show the children pictures of different priesthood ordinances (for examples, see pictures 103–8 in the *Gospel Art Book*). Help the children determine which priesthood is required for each ordinance and give that picture to the appropriate priesthood holder to hold.

HEBREWS 11:1-32

Faith is believing in things we cannot see.

Even though they can’t see Heavenly Father and Jesus Christ or experience all of the blessings of the gospel, the children you teach can develop faith by learning from the examples in Hebrews 11.

Possible Activities

- Display a picture of Jesus. Place around the room several objects to represent “evidences” that He is real even though we can’t see Him (such as the scriptures, a picture of the First Vision, and a picture of the earth). Invite the children to locate the items, and then share with them how each item helps us have faith that Jesus lives.
- Bring a fan, and let the children take turns feeling the fan blow air across their faces. Teach them that we can’t see air, but we can feel it. Similarly, we can’t see Heavenly Father and Jesus Christ, but we can feel Their love and have faith that They are real.
- Share the stories of one or more people mentioned in Hebrews 11:4–32. Consider using *Old Testament Stories* (see chapters 4–6, 8–10, 15–17, 23, and 28). What did these people do to show they had faith in something they couldn’t see? Share some blessings you have received because of your faith.

HEBREWS 13:5–6

Heavenly Father and Jesus Christ will help us and never leave us.

What trials might the children be experiencing? How might the message of Hebrews 13:5–6 help them?

Possible Activities

- Review some New Testament stories the children have learned this year in which the Savior helped others, such as when He healed the man with palsy (see Luke 5:18–26) or fed the 5,000 (see Matthew 14:15–21). Help the children learn the phrase “The Lord is my helper” (Hebrews 13:6).
- Invite the children to draw a picture of a time when they felt afraid. Read Hebrews 13:5–6 to them, and testify that Heavenly Father will help us and never leave us. Help the children cut out paper hearts large enough to cover the drawings. What are some things that help us feel closer to Heavenly Father? Write some of these things on the hearts.
- Teach the children the second verse of “Tell Me, Dear Lord” (*Children’s Songbook*, 176). According to the song, what help can we receive when Heavenly Father and Jesus Christ are near us? Talk about a time when Heavenly Father was near you and helped you.



Teach the Doctrine

Older Children

HEBREWS 7:1–4

Worthy priesthood holders follow the Savior.

How can you use these verses to help the children understand that those who hold the priesthood are to be faithful and serve others as the Savior did?

Possible Activities

- Help the children list things they know about the two great priesthood holders Abraham and Melchizedek. They can find help in Hebrews 7:1–4; Abraham 1:1–2; and Joseph Smith Translation, Genesis 14:25–40 (in the Bible appendix). What Christlike qualities did these men have that helped them honor the priesthood?
- Ask the children to read Hebrews 7:1–2 and look for the titles used to describe Melchizedek. How do these titles remind us of Jesus Christ? Help them think of ways in which Jesus was a “King of peace.” Are they aware of any other priesthood holders who are also an example of following the Savior?
- Share an experience in which a righteous priesthood holder helped you come closer to the Savior. Help the children think of ways priesthood service has blessed them.

HEBREWS 11**Heavenly Father rewards those who have faith.**

Hebrews 11 contains many examples of people who were blessed when they acted in faith. Which of the stories will be most inspiring or helpful to the children you teach?

Possible Activities

- Invite the children to make a list on the board of the things they learn about faith in Hebrews 11:1–3, 6. Give each of the children the name of someone mentioned in Hebrews 11, and invite them to read the verses associated with that person. Ask them to share clues about the person so that the other children can guess who it is. How did these people show faith, and how did Heavenly Father reward them? (For pictures of these people, see the Old Testament section of the *Gospel Art Book*).
- After reading about some of the faithful examples in Hebrews 11, ask the children to write about a person they know who showed faith. Invite several children to share their examples with the class.

HEBREWS 12:5-11**The Lord chastens those He loves.**

These verses can help the children understand that Heavenly Father, their parents, and others correct

them because they love them and want them to learn from their mistakes.

Possible Activities

- Read together Hebrews 12:5–11, and ask the children to find reasons why Heavenly Father chastens us (corrects or disciplines us). What does this teach us about why earthly parents also correct their children? How should we respond to loving correction?
- Share examples of people in the scriptures who were chastened by the Lord and repented (for example, see 1 Nephi 16:25–27; Ether 2:13–15). How are they good examples of the principles in Hebrews 12:5–11?
- After reading Hebrews 12:5–11, invite the children to write down a few things they will try to remember when they are corrected for their mistakes.

**Encourage Learning at Home**

Invite the children to write or draw a picture of what they feel is the most important thing they learned in class. Encourage them to share what they learned with their families.

Improving Our Teaching

Use activity pages. As the children are completing activity pages during class, use the time to review principles from the lesson.

Faith is believing in things we cannot see (Hebrews 11:1-32).

Color the pictures, and use scissors to cut the shape out on the solid black lines. Fold all of the dotted lines, and glue or tape the tabs to make a cube. Toss the cube and share how the person in the story on the top square showed faith. If the word *Faith* lands on top, share how you can show your faith in God.

Moses (Exodus 14)



Walls of Jericho (Joshua 6:1-20)



Abraham (Genesis 22:1-14)

FAITH
is believing in
things we
cannot see.



Noah (Genesis 6-8)

Sarah (Genesis 21:1-8)





Abraham on the Plains of Mamre,
by Grant Romney Clawson

NOVEMBER 18-24

James

“Be Ye Doers of the Word, and Not Hearers Only”

The Epistle of James contains many truths that can bless the children you teach. Follow the Spirit to determine which truths you will share with them. The ideas in this outline can also help.

RECORD YOUR IMPRESSIONS _____



Invite Sharing

Invite the children to share a gospel principle they remember learning with their family during the past week or from their Primary class last Sunday. After each child shares, invite another child in the class to summarize what was shared.



Teach the Doctrine

Younger Children

JAMES 1:5-6

I can ask Heavenly Father to help me learn what is true.

Help the children you teach understand that they can turn to Heavenly Father for wisdom. Doing so will bless them greatly when they face difficult questions.

Possible Activities

- Help the children learn the phrase “If any of you lack wisdom, let him ask of God” (James 1:5). How do we ask God questions? How does He answer us?
- Show a picture of the First Vision (*Gospel Art Book*, no. 90), and share how reading James 1:5 prompted Joseph Smith to ask Heavenly Father to help him with a question (see Joseph Smith—History 1:1-15). Share your testimony that God answers prayers, and testify that the children can pray to Him when they have questions. Let the children draw their own pictures of Joseph Smith reading James 1:5 and praying to Heavenly Father.

JAMES 3:1-13

I can say nice things.

As James testified, learning to say only kind things to others will help us become like Jesus Christ (see James 3:2).

Possible Activities

- Bring something sweet and something sour for the children to taste. Help them understand that we should use our tongues to say sweet (or kind) things and not say sour (or unkind) things (see James 3:10). Help them think of examples of nice things we can say to others.
- Give each child a simple drawing of a person speaking. Invite the children to hold it up when you say something nice we can do with our tongues (such as telling the truth, giving compliments, and offering to help someone) and put it down when you say something that we shouldn't do with our tongues (such as telling lies, calling other people names, and refusing to obey a parent).
- Reinforce the message of James 3:1–13 by singing together a song about being kind, such as “Kindness Begins with Me” (*Children’s Songbook*, 145). Suggest that the children make a “kindness jar” they can fill with pebbles or other small objects whenever they say something nice to someone.

JAMES 5:7–11

Some of God’s blessings require patience.

Patience doesn't always come naturally, especially for children. Consider how you can use James's counsel to help the children you teach learn patience.

Possible Activities

- Help the children think of times when they have had to wait for something that they really wanted. Explain that waiting for something we want without complaining is called being patient.
- Summarize James 5:7 in your own words, and show a picture of a seed or seedling. Why do we need patience when we grow plants? What would

happen if we tried to pull on the seedling to make it grow faster? Testify that God has many blessings for us, but some of them require patience.

- Share the story of Job, who is mentioned in James 5:11 as an example of patience (see “Chapter 46: Job,” *Old Testament Stories*, 165–69, or the corresponding video on LDS.org). How was Job blessed for being patient?



Teach the Doctrine

Older Children

JAMES 1:5–6

Heavenly Father will help me learn truth if I seek His help.

Although the children you teach may seem young, they are only a few years younger than Joseph Smith was when he read James 1:5 and was inspired to approach Heavenly Father in prayer. Consider how you can help the children you teach build their faith that God will help them when they lack wisdom.

Possible Activities

- Ask the children to tell you the story of Joseph Smith's First Vision in their own words (see Joseph Smith—History 1:5–19; see also the video “Joseph Smith's First Vision” on LDS.org). How did James 1:5 help Joseph? Help the children think of examples of other people in the scriptures who received an answer to their prayers (such as Nephi [1 Nephi 11:1–6] and the brother of Jared [Ether 2:18–3:9]). What are some things we can ask Heavenly Father in prayer?
- Read with the children Joseph Smith—History 1:10–14. Invite the children to find things Joseph did to receive answers to his questions. How can we follow Joseph Smith's example when we have questions?

JAMES 1:22-27; 2:14-26**“Faith without works is dead.”**

How will you help the children see the connection between what they believe and what they do?

Possible Activities

- Show the children a flashlight without batteries, a pencil without lead, or something else that is useless or “dead.” Ask the children to read James 2:14–17. How do these objects illustrate the truth in these verses?
- Invite the children to quietly read James 1:22–27; 2:14–26. Then invite them to share what they could do to show that they are doers of the word. For instance, do they know someone who is sick or lonely who they might visit, or could they resolve to serve their families more? You could also remind them of words they might have heard in sacrament meeting today. How can we be doers of these words?

JAMES 3:1-13**I can control the things I say.**

The words we say to each other may seem unimportant, but as James testified, they can have a powerful influence, for good or bad.

Possible Activities

- Is there someone in the ward, perhaps one of the children you teach, who has worked with horses or knows something about boats? You could invite him or her to provide insights about James’s teachings in James 3:3–4 about using kind words, or provide some of your own insights. What do we learn about controlling our tongues from these examples?
- Invite the children to read James 3:1–13 and to draw a picture of something they find that teaches about controlling our tongues. Give them time to share their picture and what they learned.
- After reviewing James 3:1–13 together, review the standards for language in *For the Strength of Youth* (20–21). Help the children think of something they could do to improve the way they speak to others, and encourage them to set personal goals.



Encourage Learning at Home

Invite the children to pray to Heavenly Father with a question or try to be more patient during the coming week. Ask them to share their experience in the next class.

Improving Our Teaching

Help children be active. “As you teach children, allow them to build, draw, color, write, and create. These things are more than fun activities—they are essential to learning” (*Teaching in the Savior’s Way*, 25).

I can say nice things (James 3:1-13).

To make a puppet, cut along the solid black line. Fold back the left and right sides of the page on lines 1 and 2. Then fold lines 3, 4, and 5 back and forth as illustrated below to make a girl or boy puppet. In the blank spaces inside the puppet's mouth, write down nice things you can say to others. Insert your fingers into the open ends, and use the puppet to practice saying things that are kind, true, and uplifting.

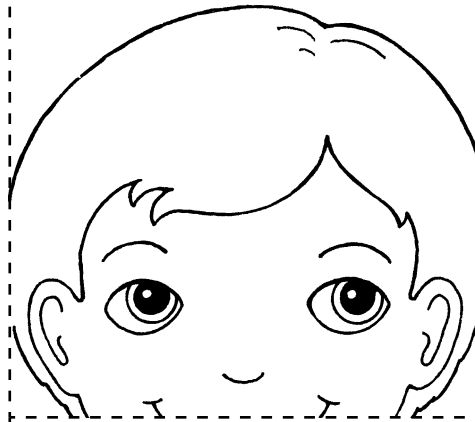

line 3

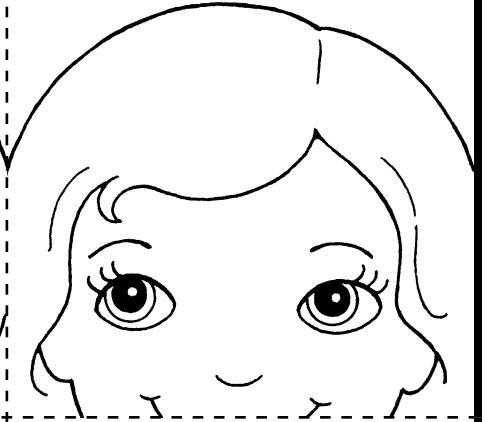

line 3

line 4

line 4

line 1

line 2

line 5

line 5

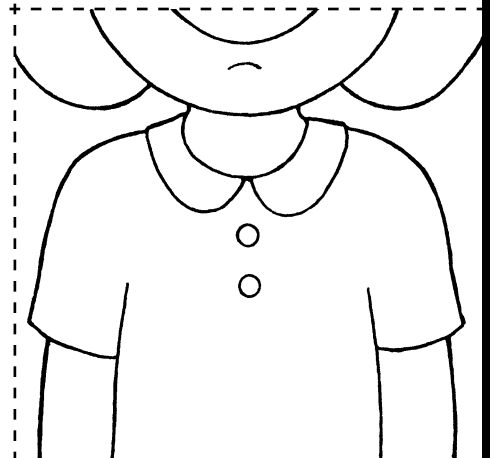
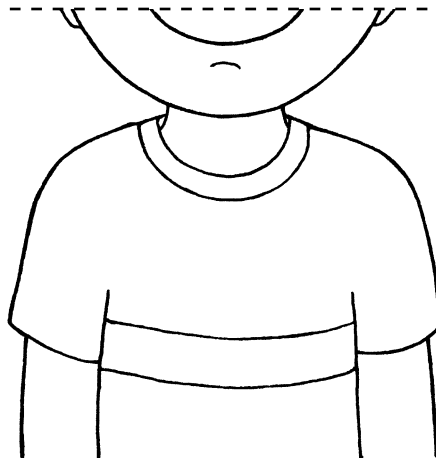
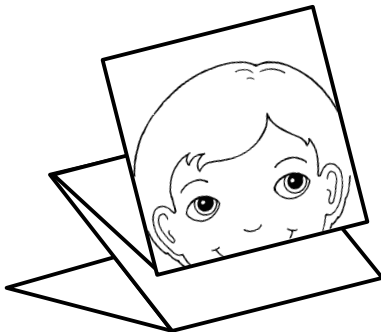



Christ Preaching in the Spirit World,
by Robert T. Barrett

NOVEMBER 25–DECEMBER 1

1 and 2 Peter

“Rejoice with Joy Unspeakable and Full of Glory”

Begin your study of 1 and 2 Peter with prayer. Remember that your best preparation to teach will come through your personal and family study experiences.

RECORD YOUR IMPRESSIONS _____



Invite Sharing

Display the picture in this week’s outline in *Come, Follow Me—For Individuals and Families*, and invite the children to tell you something they know about Peter. Remind them that Peter was the leader of the Church after Jesus was resurrected, and explain that 1 Peter and 2 Peter are letters from him to members of the Church in his day.

Possible Activities

- Invite the children to share hard things that Jesus endured, such as being crucified. Explain that we will have hard times in our lives. Read 1 Peter 1:6–7; 3:14 together, and share an experience when you faced a “trial of your faith.” Or you could share the Prophet Joseph Smith’s prayer in Liberty Jail and the comfort God gave him (see D&C 121:1–8; 123:17). How does having faith in Jesus help us find joy during hard times?



Teach the Doctrine

Younger Children

1 PETER 1:6–7; 3:14

I can be happy even during hard times.

Consider how you can teach these verses in a way that will help the children turn to the Savior when they face adversity.



Joseph Smith in Liberty Jail, by Greg K. Olsen

- Sing together a song that teaches how to find happiness, such as “I Will Follow God’s Plan” (*Children’s Songbook*, 164–65).

1 PETER 2:9–12**Heavenly Father wants me to be an example to others.**

Peter taught that we are “the people of God” and that our good works can “glorify God.”

Possible Activities

- Describe things that stand out from their surroundings, or show pictures of such things. For example, a temple stands out from the buildings around it or a mountain rises above a valley. Explain that when we keep the commandments, we stand out and other people can see our examples. Talk about some “good works” that you have seen the children do. Explain that good works like these “glorify God”—they help others feel more love for God and desire to serve Him.
- Complete the activity page with the children. How are the people they found in the picture glorifying God?

1 PETER 3:18–20; 4:6**Spirits in the spirit world learn about the gospel.**

After He died, Jesus went to the spirit world and sent the righteous spirits to teach other spirits who had not yet accepted the gospel.

Possible Activities

- Tell the children about someone you know who has died. Explain that when people die, their spirits leave their bodies and go to the spirit world. Read 1 Peter 3:19 and explain that when Jesus died, he went to visit the spirit world. There, He asked the righteous spirits to teach the gospel to other spirits who had not yet accepted the gospel (see D&C 138:30).
- Put a row of chairs down the middle of the room to act as a barrier. Ask some of the children to stand on one side to represent spirits in the spirit world

who were not baptized during their earth life. Give one of the other children a large paper key with “baptism for the dead” written on it, and ask him or her to remove the barrier. Then explain that Church members who are 12 years of age and older can go to the temple and be baptized for their ancestors who were not baptized while on earth. Then these ancestors can accept the gospel in the spirit world.

- Help the children fill out a simple family tree (see an example at “Family History Coloring Pages,” LDS.org).

**Teach the Doctrine**
Older Children**1 PETER 3:12–17; 4:13–14, 16****I can find joy and peace even during hard times.**

The children you teach may have experienced some form of teasing or mocking because of what they believe. These verses can help them during those times.

Possible Activities

- Summarize a few stories about Jesus being persecuted, or have the children read them—see, for example, Matthew 12:9–14 or Luke 22:47–54. Ask the children if they have ever been teased or mocked because they live the teachings of the gospel. Then read together 1 Peter 3:12–14; 4:13–14, 16, and ask the children to look for what Peter said about suffering “for righteousness’ sake.” Why can we still be happy when other people mock us for doing what is right?
- Invite a ward member to share an experience when he or she found joy or peace during a trial, or share how the Prophet Joseph Smith found peace when he was in Liberty Jail (see D&C 121:1–8; 123:17). How can we find joy and peace during our trials?

1 PETER 3:15**I should always be ready to share the gospel.**

The children you teach will have many opportunities throughout their lives to answer questions from other people about their faith. Consider what you can do to help them “be ready always to give an answer.”

Possible Activities

- Tell about a time when someone asked you a question about the Church, and describe whether you felt prepared to answer. Ask the children to talk about any times when people have asked them questions about the Church. Read together 1 Peter 3:15. How can we follow Peter’s counsel in this verse?
- With help from the children, think of a few questions people might ask about the Church’s teachings. Let the children take turns explaining how they would answer these questions so that they can “be ready always.”

1 PETER 3:18–20; 4:6**Spirits in the spirit world learn about the gospel.**

Help the children understand that when the righteous die, they go to the spirit world to teach the gospel to those who did not receive it while on earth.

Possible Activities

- Draw on the board a circle with a line through the middle. Write *Spirit Paradise* on one half of the circle and *Spirit Prison* on the other half. Invite one of the children to read 1 Peter 3:18–20; 4:6 (see 1 Peter 4:6, footnote *a*, for revisions from the Joseph Smith Translation). Explain that when Jesus died, He went to spirit paradise. He instructed the righteous spirits there to teach the gospel to the spirits in spirit prison.
- Invite a parent or an older sibling of one of the children to tell about going to the temple and completing work for one of their ancestors.
- Invite the children to fill out a simple family tree (see an example at “Family History Coloring Pages,” LDS.org).

**Encourage Learning at Home**

Invite the children to share their family tree with their family members and ask them for help adding names to it.

Improving Our Teaching

Seek to understand the children you teach. You know the children you teach, so modify the ideas in this outline if necessary to address their needs. You can use any of the activities suggested in this outline, not just those written for the age group you teach. (See *Teaching in the Savior’s Way*, 7.)

Heavenly Father wants me to be an example to others (1 Peter 2:9-12).

Circle or color the people who are being good examples to others.

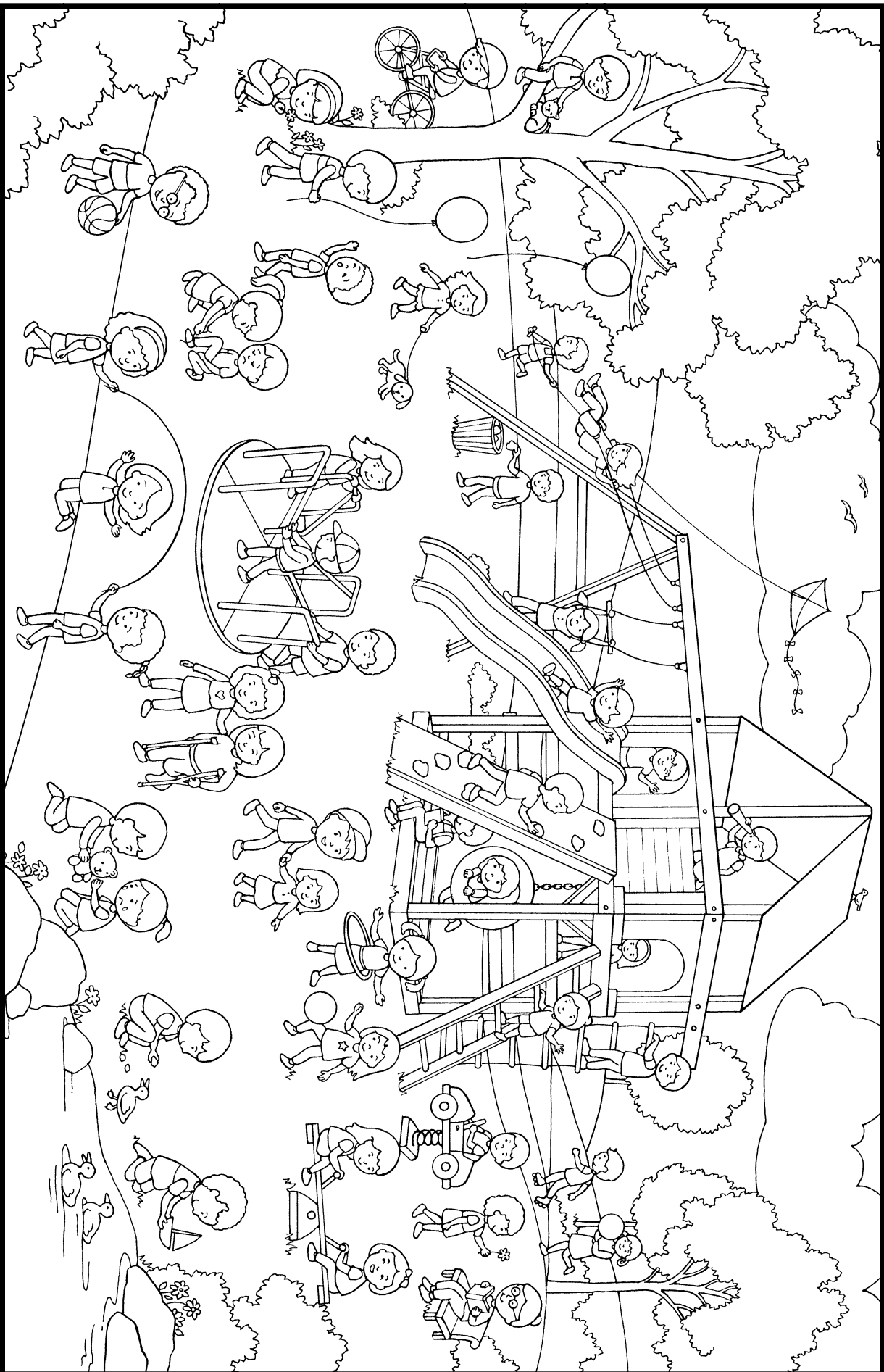



Perfect Love, by Del Parson

DECEMBER 2-8

1-3 John; Jude

“God Is Love”

The Epistles of John and Jude teach about Heavenly Father’s love and light. As you study this week, ponder why the children you teach need His light and love in their lives. Remember to consider all of the activities in this outline, not just those listed under the age-group you teach.

RECORD YOUR IMPRESSIONS _____



Invite Sharing

Invite the children to share how they have felt Heavenly Father’s love or why they think Heavenly Father is like a light.



Teach the Doctrine Younger Children

1 JOHN 1:5-7; 2:8-11

Following Jesus brings light to my life.

How can comparisons to physical light and darkness help you teach the children about the light that Heavenly Father brings into their lives?

Possible Activities

- Ask the children to name things that produce light. Help them understand the benefits of light, like

helping plants grow, allowing us to see, and giving warmth. Invite the children to take turns shining a flashlight at a picture of Jesus Christ as they say, “God is light” (1 John 1:5). Testify that Heavenly Father and Jesus Christ can bring light into our lives when we obey the commandments.

- Darken the classroom, and invite the children to suggest ways light could be brought into the room. Help them think of ways we can bring the light of Jesus Christ into our lives. As they share their answers, turn on flashlights or uncover a window to gradually add light to the room.

1 JOHN 4:10-11, 20-21

I show my love for God when I show love to others.

Help the children see the connection between the love they feel for Heavenly Father and the love they show to His children.

Possible Activities

- Read 1 John 4:11 to the children, and sing a song about God's love, such as "My Heavenly Father Loves Me" (*Children's Songbook*, 228). Ask a few children to share how they know that Heavenly Father loves them. After each answer, invite the children to hug themselves and say, "God is love, and God loves me."
- Read 1 John 4:21 to the children. Invite them to share or act out various ways they could show love toward a friend, such as giving a hug or making a card. How do these things make our friends feel? How does Heavenly Father feel when we do kind things for others?

1 JOHN 2:3-5; 5:3

I show my love for God when I keep His commandments.

Children can learn at a young age that God's "commandments are not grievous" and that following them are a way to express love to Him.

Possible Activities

- Read 1 John 5:3, and ask the children to listen for what this verse says about how we can show that we love God. Invite the children to name as many commandments as they can. How does Heavenly Father feel when we obey His commandments?
- Invite the children to draw a picture showing one way they can express their love for Heavenly Father. For example, they could draw a picture of themselves keeping one of the commandments. Sing together a song about obedience, such as "Choose the Right Way" (*Children's Songbook*, 160). How do we feel when we obey?



Teach the Doctrine

Older Children

1 JOHN 2:8-11; 4:7-8, 20-21

I show my love for God when I show love to others.

How can you help the children understand that loving God involves loving those around us—even people who may be different from us or difficult to love?

Possible Activities

- Ask the children to imagine that someone new has begun attending their school or ward and does not yet know anyone there. How might this person feel? Invite a child to read 1 John 4:7-8. What does this verse suggest about how we should treat this person? Share similar scenarios, or ask the children to think of situations in which they might have opportunities to show love.
- Ask the children to read 1 John 4:7-8, 20-21, and invite them to each write one sentence to summarize what they think is the most important lesson in these verses. After they share their sentences, you might tell the story of Chy Johnson from Brother David L. Beck's talk "Your Sacred Duty to Minister" (*Ensign or Liahona*, May 2013, 55). How can the children follow the examples of the young men in the story who showed love for Chy? Invite the children to share other ways they can show love to those around them.

1 JOHN 2:3-6; 4:17-18; 5:2-5

I show my love for God when I keep His commandments.

Obeying the commandments can be easier when we understand the truths taught in 1 John 5:3. How can you help the children see the commandments not as burdens but as opportunities to express their love for God?

Possible Activities

- Invite the children to list on the board ways they can show God that they love Him. Then read together 1 John 2:5–6; 5:2–5 for additional ideas. How does obeying the commandments show that we love Heavenly Father?



Even when it's hard, we can choose to keep the commandments.

- Read 1 John 4:17, and explain to the children that to “have boldness in the day of judgment” means having confidence and peace when they stand before God to be judged. What does this verse teach that we need to do to have this confidence? What are some things we can do now to be confident before God?

JUDE 1:18–22

I can be faithful even when others make fun of me.

Children may be mocked for their beliefs or the way they live as disciples of Jesus Christ. These verses contain Jude’s counsel on how to remain faithful in such situations.

Possible Activities

- Ask children to share times when they have been made fun of for doing what is right. Invite the children to read Jude 1:18–22 and look for how we can remain faithful when we are mocked or made fun of. Write what they find on the board, and discuss ways they can follow this advice.
- Summarize Lehi’s dream (see 1 Nephi 8:1–35), asking a few children to read verses from 1 Nephi 8:26–28, 33. Discuss how the people in the great and spacious building were like the mockers Jude talked about. What can we do to not be influenced by those who make fun of us or don’t agree with what we believe? (see 1 Nephi 8:30, 33).



Encourage Learning at Home

Encourage the children to make a plan to do something to share their light with their families.

Improving Our Teaching

Children are active. At times you may feel that the children’s energy is a distraction from learning. But you can build on their active natures by inviting them to act out, draw, or sing about a gospel principle. (See *Teaching in the Savior’s Way*, 25–26.)

Following Jesus brings light to my life (1 John 1:5-7; 2:8-11).

Color the picture of Jesus. Place this paper on carpet or a folded towel, and use a thumbtack to poke holes through the dots. Cut out the circle and hang it in a window to allow the light to shine through the holes.

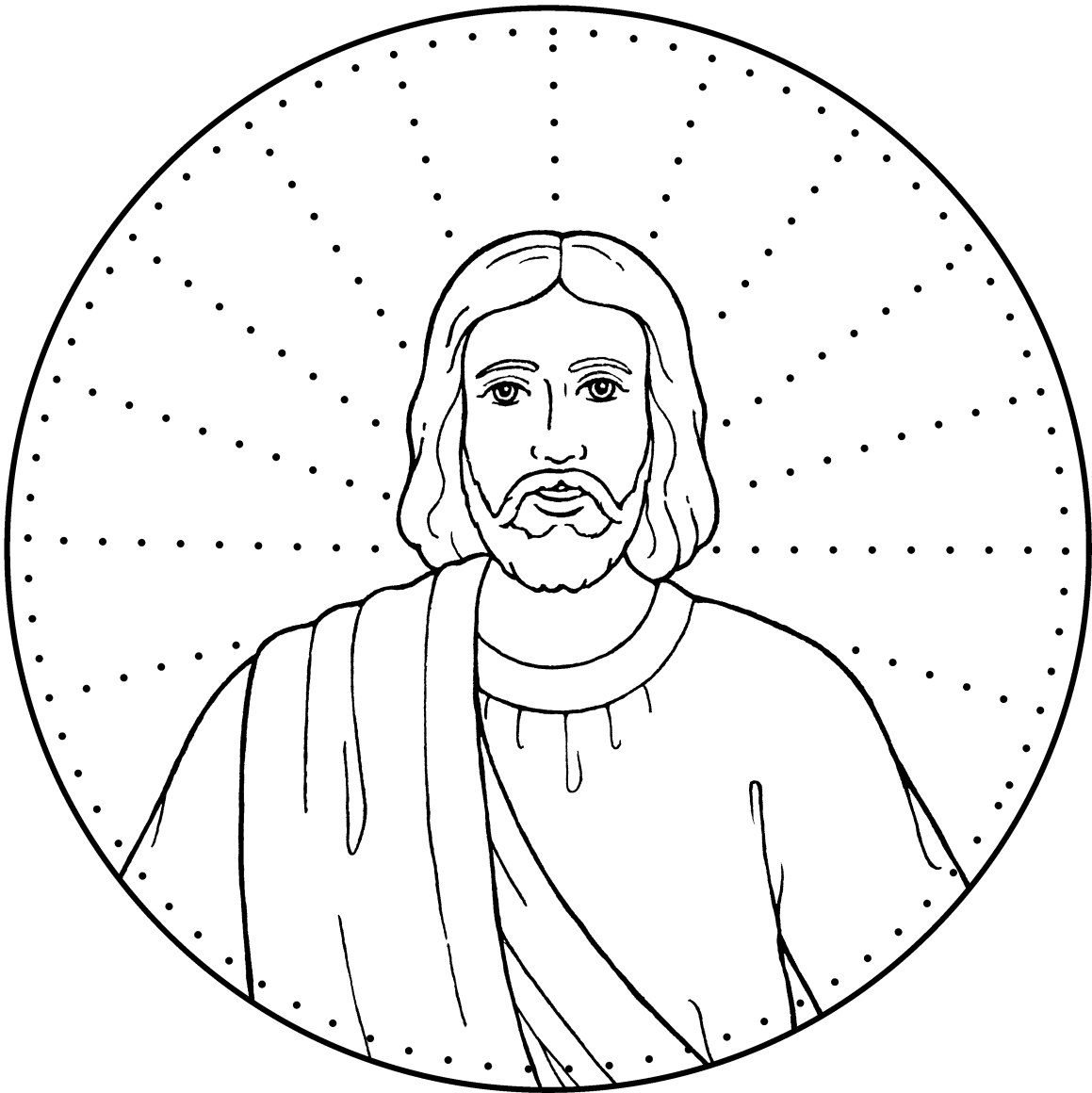



The Good Shepherd, by Del Parson

DECEMBER 9-15

Revelation 1-11

“Glory, and Power, Be unto . . . the Lamb for Ever”

The symbolism in Revelation can be difficult for children to understand, but Revelation also contains important doctrine that is beautiful and simple.

RECORD YOUR IMPRESSIONS _____



Invite Sharing

Invite the children to share how they might feel if they saw Jesus Christ in a vision. Explain that in the book of Revelation, John described a vision in which he saw Jesus and many important things about the past and the future.

Revelation 3:20. Invite the children to imagine that Jesus was knocking on the door to their homes. Would they let Him inside? What do they think He would say or do?

- Invite the children to tell you about times when they waited for someone to visit their home that they were excited to see. What was it like waiting for that person to knock on the door? What if they never let the person inside? Read Revelation 3:20, and let the children take turns holding a picture of Jesus and pretending to knock on a door. The other class members could pretend to open the door. What can we do to let Jesus be near us, even though we can't see Him? Consider giving each child a picture of Jesus to take home.



Teach the Doctrine Younger Children

REVELATION 3:20

I can invite Jesus Christ into my life.

The metaphor of Jesus standing at the door and knocking can help the children understand that He wants to be close to them.

Possible Activities

- Show the picture from this week's outline in *Come, Follow Me—For Individuals and Families* and read

REVELATION 5:1-10

Jesus Christ is the only one worthy to be my Savior.

John learned from his vision that only Jesus Christ (represented by a lamb) could be our Savior and fulfill the Father's plan (represented by the sealed book).

Possible Activities

- Before class, find pictures that represent blessings available because of Jesus Christ's Atonement (such as the temple, baptism, and families), place them in a book, and wrap the book up with paper or string. Using a few key phrases from Revelation 5:1–10, describe the vision John saw. Show the children the book, and tell them that the only way to open the book is to find the picture of Jesus that you have hidden in the room. When they find the picture, open the book and share with the children the pictures in the book. Testify that the Savior was the only one who could make those things possible.
- Summarize the vision described in Revelation 5:1–10, and invite the children to act out how John and others felt during different parts of the vision. For instance, they might pretend to cry when no one could open the book, or they might cheer when the Savior opened it.

REVELATION 7:9, 13–14

Jesus Christ helps me become clean from sin.

John saw many people dressed in robes “made . . . white in the blood of the Lamb” (verse 14). Consider how this vision could help the children understand the importance of being made clean from our sins through the Atonement of Jesus Christ.

Possible Activities

- Show the children some baptismal clothing or other white clothes and a picture of Jesus. Read Revelation 7:9, 13–14 to the children, and ask them to point to the picture and clothes every time they hear the word *white*. Explain that white clothes represent cleanliness and remind us that Jesus Christ can make us clean from our mistakes.
- Show the children a piece of white cloth, and let them get it dirty by marking it with a pen or putting dirt on it. Explain that sin makes our spirits dirty. Show a picture of Jesus in Gethsemane (such as

Gospel Art Book, no. 56), put the dirty cloth away, and show them a clean white cloth. Testify that through the Atonement of Jesus Christ, we can become clean.

- Sing a song about baptism, such as “When I Am Baptized” (*Children's Songbook*, 103), and discuss how Jesus helps us become clean when we are baptized.



Teach the Doctrine

Older Children

REVELATION 3:20

I can choose to let Jesus Christ be a part of my life.

How can you help the children you teach open their hearts and lives to the power and influence of Jesus Christ?

Possible Activities

- Invite the children to look at the picture from this week's outline in *Come, Follow Me—For Individuals and Families* as you read Revelation 3:20. To help them draw meaning from the picture, invite them to work in pairs to answer questions like these: Why do you think Jesus is knocking on the door? Why isn't there a doorknob on the outside of the door? What does it mean to let Jesus into our lives?
- Ask the children to write on the board different ways to “open the door” to Jesus. Some examples might include serving others, reading the scriptures, and partaking of the sacrament.

REVELATION 5:1–10

Jesus Christ is the only one worthy to be my Savior.

The vision described in Revelation 5 taught that only Jesus Christ was worthy and able to perform the Atonement and save us from sin.

Possible Activities

- Invite the children to tell about a time when they needed someone to do something they couldn't do for themselves. Ask them to read Revelation 5:1–10 and look for what needed to be done that only one person could do (explain that the Lamb is Jesus Christ and the book represents God's plan). What did Jesus do for us that no one else could do?
- Ask the children to look for a hymn or children's song that testifies of Jesus Christ (such as "Beautiful Savior," *Children's Songbook*, 62–63). What do the words of the song teach about Jesus Christ? How might this song be like the hymn of praise sung about Jesus Christ in Revelation 5:9–10?

REVELATION 9:1-2

The gospel can help me overcome temptation.

The smoke that darkened the air in Revelation 9:2 could be likened to temptations (see 1 Nephi 12:17).

Possible Activities

- Draw pictures of a sun and a dark cloud, and cut them out. Invite the children to read Revelation 9:2 and 1 Nephi 12:17 and write on the dark cloud what the smoke or mists in these verses represent. Place the dark cloud on the board, and invite the children to make a list of temptations children their age face. Then place the sun on the board and ask them to make a list of tools Heavenly Father has given us to overcome the darkness in the world.
- How can the children help others who are in the dark spiritually? To help them think about this question, show the video "Choose the Light" (LDS.org), and invite them to talk about the biker.



Encourage Learning at Home

Invite the children to share with their families ways they can invite the Savior's influence into their homes.

Improving Our Teaching

Encourage reverence. An important aspect of reverence is thinking about Heavenly Father and Jesus Christ. You might remind children to be reverent by quietly singing or humming a song or displaying a picture of Jesus.

I can invite Jesus Christ into my life (Revelation 3:20).

Color the picture, and write or draw things you can do to invite Jesus Christ into your life. Cut around the image on the dark lines, and cut out the circles. Fold on the dotted line, and hang on a doorknob at home.

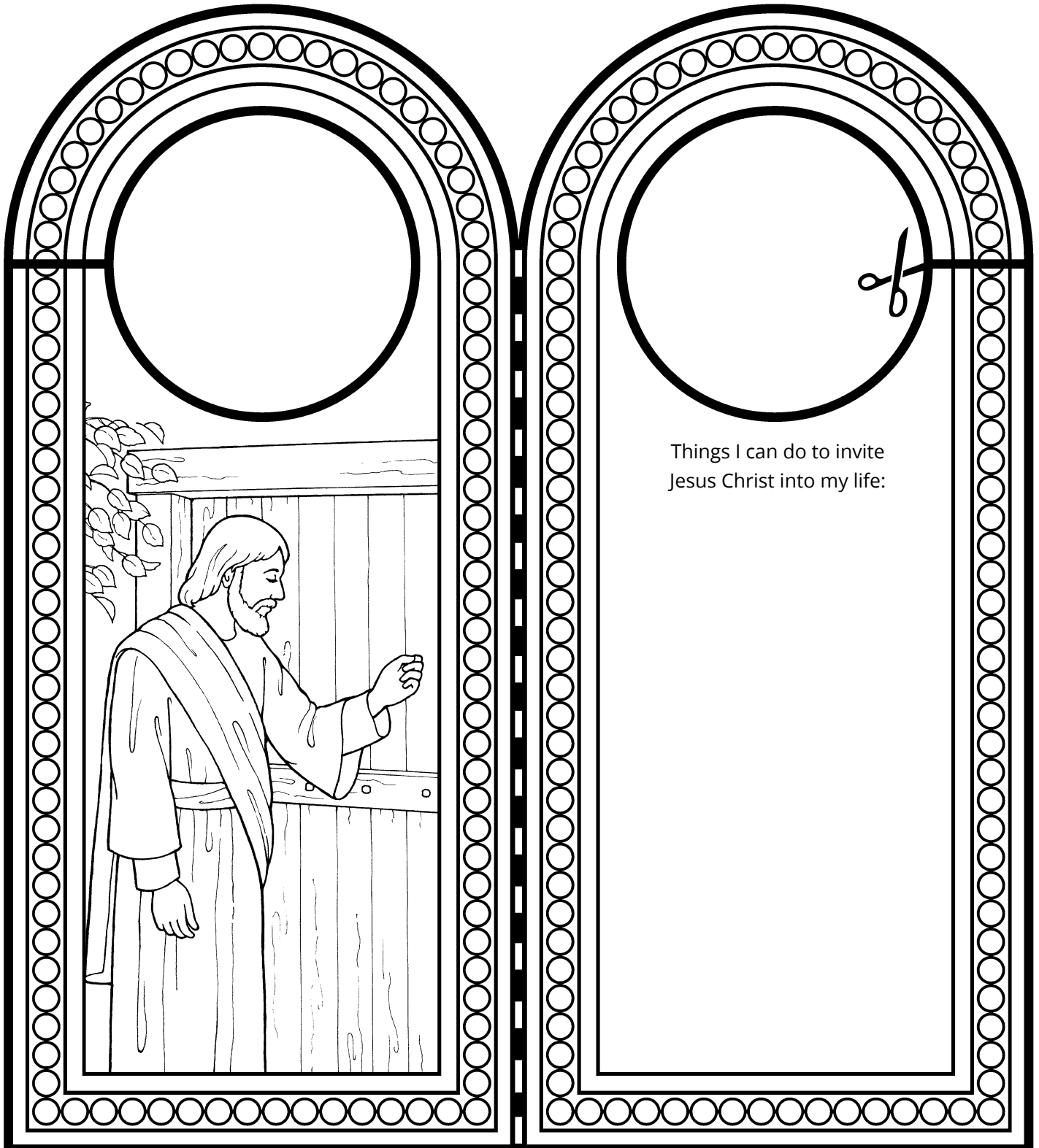

Things I can do to invite
Jesus Christ into my life:



Safe in a Stable, by Dan Burr

DECEMBER 16–22

Christmas

“Good Tidings of Great Joy”

This lesson is an opportunity to help the children you teach celebrate the Savior’s birth, life, and mission at Christmastime. Keep this thought in mind as you prepare to teach.

RECORD YOUR IMPRESSIONS _____



Invite Sharing

Display the picture in this week’s outline in *Come, Follow Me—For Individuals and Families*, and invite the children to share what they know about the Savior’s birth.



Teach the Doctrine

Younger Children

MATTHEW 2:1–12; LUKE 2:1–14

Jesus Christ came to earth as a baby.

The story of Jesus Christ’s birth appeals to children. What doctrinal truths do you see in this story that you feel the children should understand?

Possible Activities

- Read Luke 2:1–14 to the children, or describe the events in these verses by referring to “Chapter 5:

Jesus Christ Is Born,” *New Testament Stories*, 13–15, or the corresponding video on LDS.org. Invite the children to draw pictures of these events and use the pictures to tell the story themselves. Why are you happy that Jesus came to earth as a baby?

- Ask the children to tell you the story of the Wise Men following the star to find Jesus. If they need to be reminded of the story, see Matthew 2:1–12 or “Chapter 7: The Wise Men,” *New Testament Stories*, 18, or the corresponding video on LDS.org. Hide a picture of Jesus in the room. Draw or cut out a paper star and hold it in the air. Invite the children to pretend to be wise men carrying gifts, and lead them around the room to find Jesus. What are some gifts that we can give to Jesus in our lives today?
- Sing a few Christmas songs with the children, such as “Joy to the World” and “Silent Night” (*Hymns*, nos. 201, 204) or “Stars Were Gleaming,” “Away in a Manger,” and “Oh, Hush Thee, My Baby” (*Children’s Songbook*, 37, 42–43, 48).

JOHN 3:16**Jesus Christ made it possible for me to live with Heavenly Father again someday.**

Do the children you teach understand why Jesus Christ came to earth? Take time to ponder what the Savior has done for you personally and how you can help the children understand what He has done for them.

Possible Activities

- Bring a wrapped gift to class with a picture of Jesus Christ inside. Put a tag on the gift with “John 3:16” written on it, and tell the children that this is a clue about what the gift is. Read John 3:16 with the children, and invite them to guess what the gift is and open it. Why did God send us His Son?
- Select pictures from the *Gospel Art Book* (such as nos. 1, 30, 35–66, 84) that illustrate some of the ways Jesus blessed other people while He lived on the earth. Let the children hold the pictures while you tell the stories. You may want to select pictures that go with the words to “He Sent His Son” and “Tell Me the Stories of Jesus” (*Children’s Songbook*, 34–35, 57) and let the children hold up the pictures as they sing these songs.
- Invite the children to share their favorite stories about Jesus. After each story is told, help the children finish this sentence: “Jesus Christ came to earth to _____.” Then show pictures related to the Savior’s atoning sacrifice, death, and Resurrection (see *Gospel Art Book*, nos. 56, 57, 58, 59) and briefly tell about these events. Bear your testimony that Jesus Christ came to earth to die for us and be resurrected so we can return to Heavenly Father.



Gethsemane, by J. Kirk Richards



Teach the Doctrine

Older Children

MATTHEW 1:18–25; 2:1–12; LUKE 1:26–38; 2:1–20

Jesus Christ came to earth as a baby.

How can you help the children focus on Jesus Christ at Christmas?

Possible Activities

- Invite one of the children to read about events related to the Savior’s birth in Matthew 1:18–25; 2:1–12; Luke 1:26–38; 2:1–20. Ask the other children to take turns drawing pictures on the board of what the scriptures are describing. What do these stories teach us about Jesus Christ?
- Show the video “Good Tidings of Great Joy: The Birth of Jesus Christ” (LDS.org). Ask the children to write down anything they hear that will help them focus on Jesus Christ at Christmastime. After the video, invite them to share what they wrote.
- Invite the children to write on several slips of paper things they could do to help them focus on the Savior during the Christmas season. Put their papers in bags or other containers for the children to take home. Some ideas may include reading the scriptures, singing Christmas hymns, and doing sincere acts of love.

- Sing Christmas songs about the Savior (see *Children's Songbook*, 36–54; *Hymns*, nos. 201–214), and invite the children to share a favorite line or phrase from the songs.

JOHN 3:16

Jesus Christ made it possible for me to live with Heavenly Father again someday.

How can you help the children review what they have learned this year and understand why they need Jesus Christ in their lives?

Possible Activities

- Label two pieces of paper *Who is Jesus Christ?* and *Why did He come to earth?* and attach them to different walls of the classroom. Invite each child to read one of the following scriptures: Matthew 16:15–16; John 3:16; 1 Nephi 10:4; Mosiah 3:8; Alma 7:10–13; 3 Nephi 27:14–15. Ask the children to look for answers to the two questions on the walls in the

scriptures they read. Invite them to write their answers on pieces of paper and attach them to the wall next to the appropriate question. How can we show our gratitude for what Jesus Christ has done for us?

- Invite the children to list on the board all of the names or titles of Jesus that they can think of (see Bible Dictionary, “Christ, names of”). What do these names teach us about Jesus Christ and His mission? Why do we need Jesus Christ in our lives? To help answer this question, show the video “Why We Need a Savior—A Christmas Message about Our Savior Jesus Christ” (LDS.org).



Encourage Learning at Home

Encourage the children to find at least one way to serve someone else or come closer to Jesus Christ this Christmas.

Improving Our Teaching

Children like to share what they are learning. Even young children can strengthen their family members. Encourage the children you teach to share with their family something they learned in Primary. (See *Teaching in the Savior's Way*, 30.)

Jesus Christ came to earth as a baby (Matthew 2:1-12; Luke 2:1-14).

Color and cut out the pieces of the manger scene. Fold the pieces on the dotted lines. Use the illustration to help you paste or tape the pieces to make a manger scene.

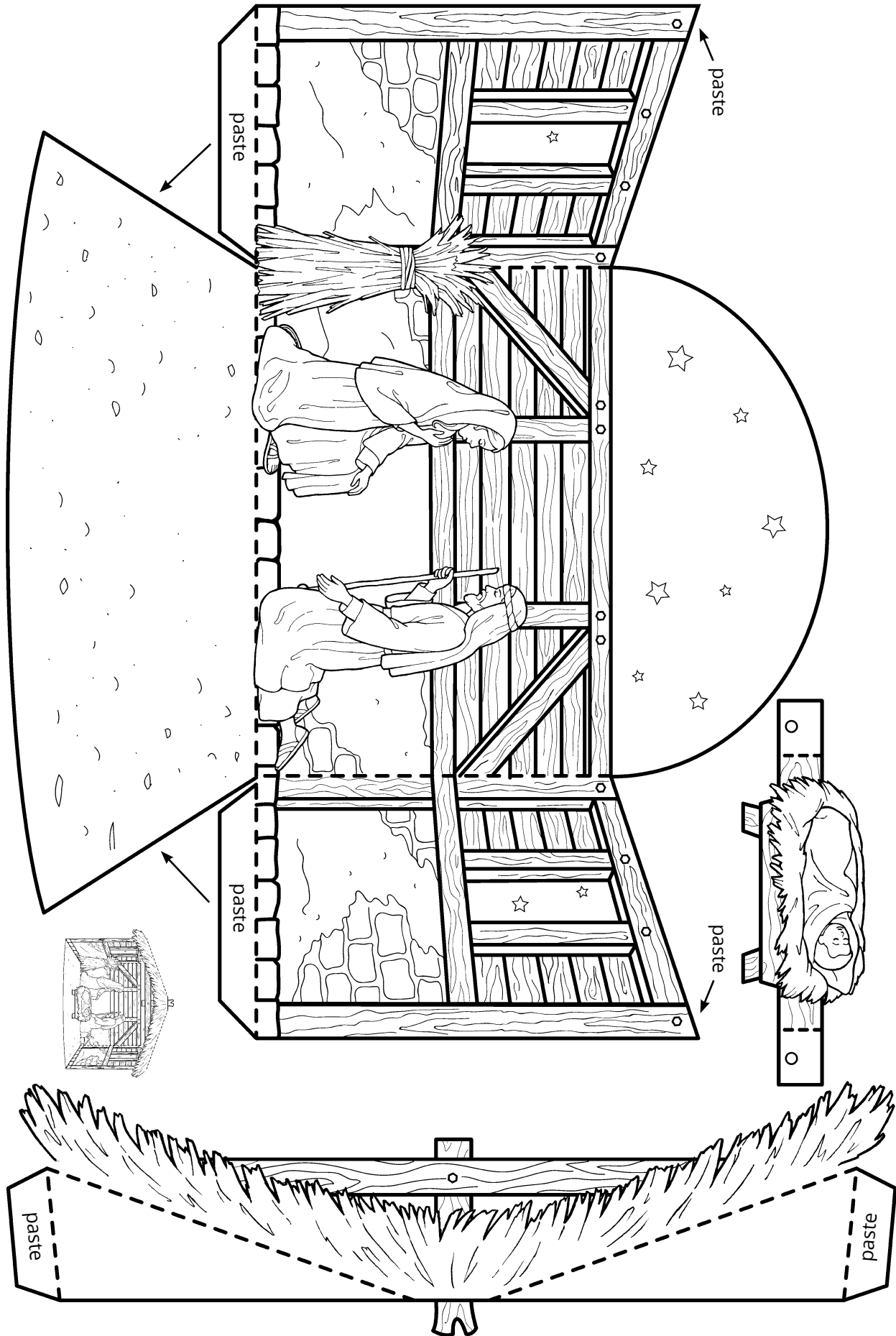



The City Eternal, by Keith Larson

DECEMBER 23–29

Revelation 12–22

“He That Overcometh Shall Inherit All Things”

As you prepare to teach, draw upon your experience with studying Revelation 12–22 personally or with your family. What stood out to you? What impressions did you receive? Remember that the activities suggested here can be adapted for children of any age.

RECORD YOUR IMPRESSIONS _____



Invite Sharing

Invite the children to share why they want to live with Heavenly Father again. Throughout the lesson, help them look for things they can do to prepare to return to Him.



Teach the Doctrine

Younger Children

REVELATION 12:7–11

I showed faith in Jesus Christ in the premortal life.

In the War in Heaven, God’s faithful children overcame Satan by “the word of their testimony” and by showing faith in Jesus Christ (Revelation 12:11).

Possible Activities

- To help the children understand what it means to follow someone’s example, choose one child to be

a “leader,” and ask the others to follow him or her by doing whatever he or she does. Then let other children be the leader. Read Revelation 12:7–11 to the children and explain that before we were born, we chose to follow Jesus and not Satan.

- Sing together a song about the premortal life, such as “I Lived in Heaven” or “I Will Follow God’s Plan” (*Children’s Songbook*, 4, 164–65). Ask questions like, What happened in heaven before we were born? What did we choose to do? (See also “Introduction: Our Heavenly Father’s Plan,” *New Testament Stories*, 1–5, or the corresponding video on LDS.org.)

REVELATION 19:7

I can prepare for the Second Coming of Jesus Christ by choosing the right.

How can you help the children understand that the Second Coming will be a joyful event for us if we follow Jesus’s commandments?

Possible Activities

- Display the picture in this week’s outline in *Come, Follow Me—For Individuals and Families*, and read Revelation 19:7. Explain that the “marriage of the Lamb” represents the Second Coming of Jesus Christ. Why were the people “glad”? Ask the children if they’ve ever been to a wedding. What was it like? Why were the people happy?
- Share with the children why you are looking forward to Jesus’s Second Coming. You could also sing together a song about the Second Coming, such as “When He Comes Again” (*Children’s Songbook*, 82–83).
- Invite the children to share what they do to get ready for church on Sunday. Why do we do these things before we come to church? Why should we prepare for Christ’s Second Coming? On this week’s activity page, let the children draw what they can do to prepare for the Second Coming.

REVELATION 21:1, 3–4, 22–27; 22:1–2

I can live in the celestial kingdom with Heavenly Father and the people I love.

In the last two chapters of Revelation, John used beautiful language to describe the celestial glory that the faithful will enjoy.

Possible Activities

- Let the children draw the tree described in Revelation 22:2 on the board. Explain that this tree is the tree of life, and its fruit represents the love of God (see 1 Nephi 11:21–22). Give the children pieces of paper shaped like fruit, and invite them to draw on the paper something that helps them feel Heavenly Father’s love. Explain that those who are faithful will live with Heavenly Father in the celestial kingdom.
- Share with the children some images or details that John used to describe celestial glory (see Revelation 21:1, 3–4, 22–27; 22:1–2), and invite the children to draw pictures of these things.
- Sing together a song about God’s plan, such as “I Will Follow God’s Plan” (*Children’s Songbook*, 164–65). Invite the children to identify what they can do to live with Heavenly Father again.



Teach the Doctrine Older Children

REVELATION 12:7–11

I showed faith in Jesus Christ in the premortal life.

The children you teach are on earth because they had faith in Jesus Christ in the premortal life and chose to follow Him.

Possible Activities

- Read together Revelation 12:7–11, and write on the board the words *dragon*, *War in Heaven*, *cast out*, *testimony*, and *Lamb*. Ask the children to summarize these verses using the words on the board. What do we learn about Jesus Christ (the Lamb) from these verses? What do we learn about the choices we made in the premortal life?
- On the board, create three columns and label them *Before this life*, *During this life*, and *Both*. Prepare strips of paper that state truths about the premortal life and about mortal life, such as *We have bodies*, *We don't have bodies*, *We live in God's presence*, *We are at war with Satan*, *We exercise faith in Jesus Christ*, and *We follow God's plan*. Let the children take turns picking a paper strip and deciding which column it belongs in. Share your confidence that the children can continue to show faith in Christ.

REVELATION 19:7-8**I can prepare for the Second Coming of Jesus Christ by choosing the right.**

How can you help the children you teach understand that the Second Coming of Jesus Christ will be a joyous event for the righteous?

Possible Activities

- Read together Revelation 19:7-8, and help the children understand the symbolism in these verses—the marriage is the Savior’s Second Coming, the Lamb is the Savior, and His wife is the Church (or all of us). How do people prepare for a marriage? What things might we do to prepare for the Savior to come again?
- Review and memorize Articles of Faith 1:10 with the children. Explain that this article of faith describes exciting, glorious events that will happen when Jesus comes again. Display the picture of Jesus’s Second Coming in *Come, Follow Me—For Individuals and Families*, and invite the children to draw what they think Jesus’s Second Coming will be like.

REVELATION 21:1, 3-4, 22-27; 22:1-2, 17**I can live in the celestial kingdom with Heavenly Father and the people I love.**

As you prepare to teach about the celestial kingdom, reflect on what the celestial kingdom means to you.

How can you share your testimony with the children you teach?

Possible Activities

- Invite the children to search the following verses for some images or details that John used to describe celestial glory: Revelation 21:1, 3-4, 22-27; 22:1-2. Let them choose an image or detail that they would like to draw. Then they can talk about their drawings with the class. Encourage them to show their drawings to their families at home.
- Read together Revelation 22:17, and explain that the bride who says “Come” is the Church. What do we want to invite others to “come” to? What are some good ways to invite people to “come”?

**Encourage Learning at Home**

Help the children prepare to read the Book of Mormon next year by inviting them to ask a family member or friend to share a favorite verse or story from the Book of Mormon.

Improving Our Teaching

Teach children to record impressions. If children can learn the habit of recording impressions, it will help them recognize and follow the Spirit. Children can record impressions by marking scriptures, drawing pictures, or making simple journal entries. (See *Teaching in the Savior’s Way*, 30.)

**I can be prepared for the Second Coming of Jesus Christ
as I choose the right (Revelation 19:7; 11-14).**

Color the picture of Jesus Christ and people doing things to prepare for His Second Coming.
In the space provided, draw something you can do to prepare for Him to come again.

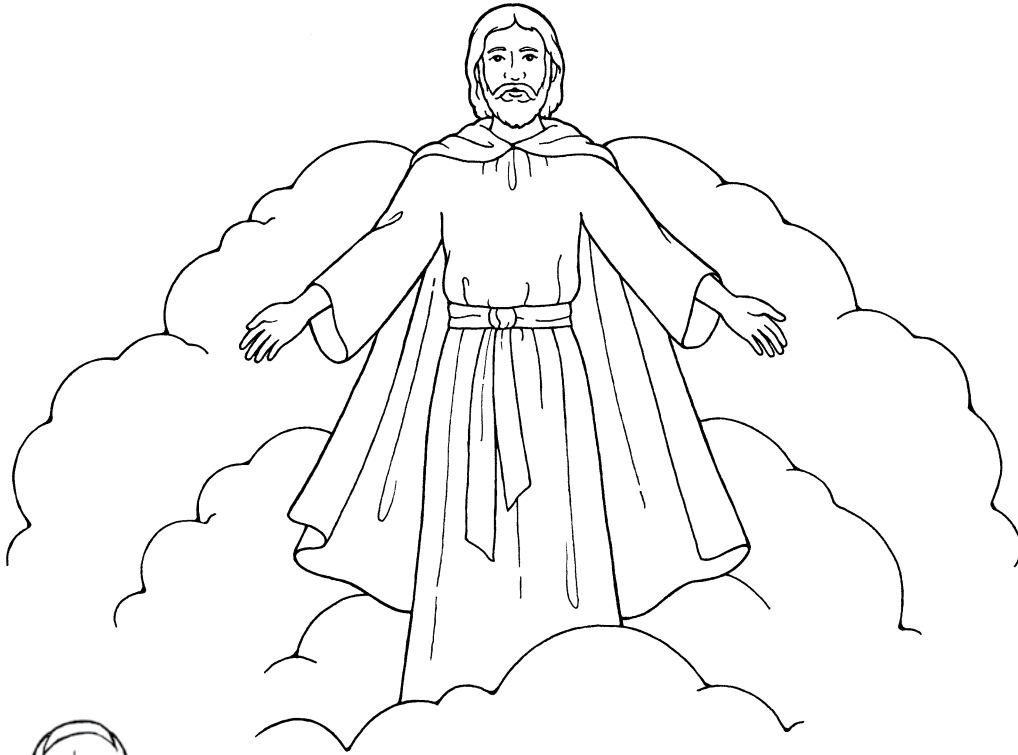

What I can do to prepare

THE CHURCH OF
JESUS CHRIST
OF LATTER-DAY SAINTS

